

**MICRA 80 A3**  
**MICRA 80 A4**

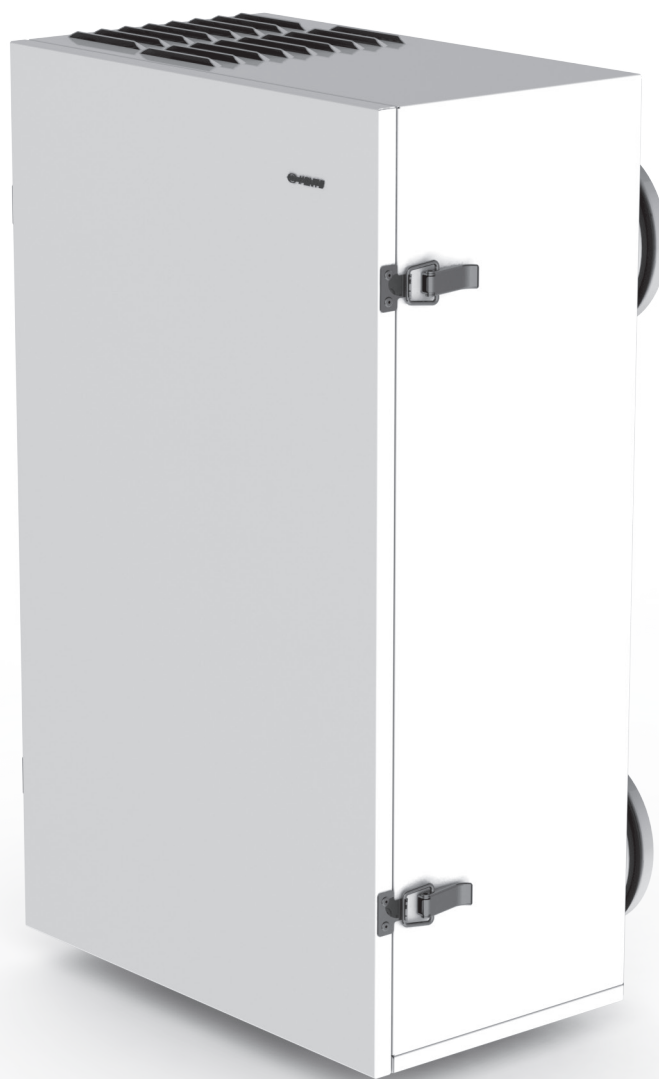

**Energy recovery  
air handling unit**



**CONTENTS**

Safety requirements .....	3
Introduction .....	5
Purpose .....	5
Delivery set .....	5
Designation key .....	5
Technical data .....	6
Unit design and operating principle .....	7
Mounting and set-up .....	8
Connection to power mains .....	10
Unit control .....	10
Technical maintenance .....	11
Troubleshooting .....	12
Storage and transportation regulations .....	12
Manufacturer's warranty .....	13
Acceptance certificate .....	14
Seller information .....	14
Installation certificate .....	14
Warranty card .....	15







**SAFETY REQUIREMENTS**

- Read the user’s manual carefully prior installing and operating the energy recovery air handling unit (hereinafter referred to as «the unit»).
- Fulfil the operation manual requirements as well as the provisions of all the applicable local and national construction, electrical and technical norms and standards.
- The warnings contained in the user’s manual must be considered most seriously since they contain vital personal safety information.
- Failure to follow the rules and safety precautions noted in this user’s manual may result in an injury or unit damage.
- After a careful reading of the manual, keep it for the entire service life of the unit.
- While transferring the unit control the user’s manual must be turned over to the receiving operator.



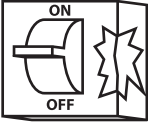

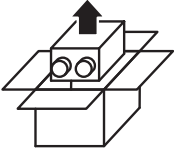

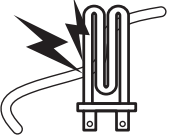
Symbol legend:

	<b>WARNING!</b>
	<b>DO NOT!</b>

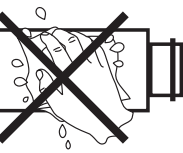
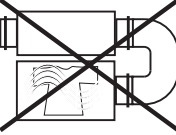
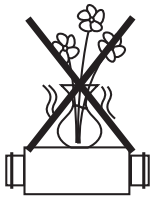
**UNIT MOUNTING SAFETY PRECAUTIONS**

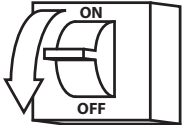
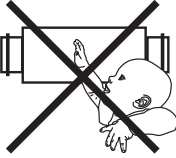
	Disconnect the unit from power mains prior to any installation or repair operations.		The unit must be grounded!
	The unit must not be operated outside the temperature range stated in the user's manual and in aggressive or explosive environments.		Do not use damaged equipment or cables when connecting the unit to power mains.
	While installing the unit follow the safety regulations specific to the use of electric tools.		Unpack the unit with care.
	Do not change the power cable length at your own discretion. Do not bend the power cable. Avoid damaging the power cable.		Do not position any heating devices or other equipment in close proximity to the unit power cable.

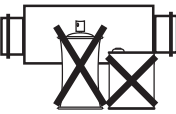
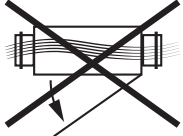
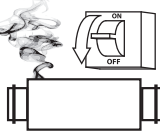
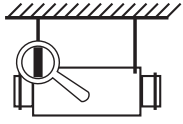
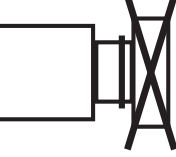
## UNIT OPERATION SAFETY PRECAUTIONS

	Do not touch the unit controls with wet hands. Do not carry out the unit maintenance with wet hands.		Do not wash the unit with water. Protect the unit electric parts from water ingress.
	Use the unit only as intended by the manufacturer. Do not connect a clothes dryer or other similar equipment to the unit or the ventilation system.		Do not put any water containers on the unit, i.e. flower vases.
	Do not sit on the unit and do not put any objects on it.		Disconnect the unit from power mains prior to any technical maintenance.
	Do not let children operate the unit.		Do not damage the power cable while operating the unit. Do not put any foreign objects on the power cable.
	Keep combustible gases and inflammable products away of the unit.		Do not open the operating unit.
	When the unit generates unusual sounds, odour or emits smoke disconnect it from power supply and contact the Seller.		In case of continuous operation of the unit periodically check the security of mounting.
	Do not block the air duct when the unit is on.		Do not let air flow from the unit be directed to the open flame devices or candles.

## INTRODUCTION

The present User's manual contains the technical details, operating instructions and technical specification for the unit.

## PURPOSE

The unit is an energy saving device based on energy recovery technology and is one of the energy saving components used in the buildings and premises.

The unit is a component part and is not designed for stand-alone operation.

The unit is designed to ensure continuous mechanical air exchange in houses, offices, hotels, cafés, conference halls and other utility and public spaces as well as to recover the heat energy contained in the air extracted from the premises to warm up the filtered stream of supply air.

The units are designed for wall mounting.

The unit is rated for continuous operation.

Transported air must not contain any flammable or explosive mixtures, evaporation of chemicals, sticky substances, fibrous materials, coarse dust, soot and oil particles or environments favourable for the formation of hazardous substances (toxic substances, dust, pathogenic germs).



**THE UNIT MAY NOT BE OPERATED BY CHILDREN OR PERSONS WITH REDUCED PHYSICAL, MENTAL OR SENSORY CAPACITIES, OR LACKING THE APPROPRIATE TRAINING. THE UNIT MUST BE INSTALLED AND CONNECTED ONLY BY PROPERLY QUALIFIED PERSONNEL AFTER THE APPROPRIATE BRIEFING. THE CHOICE OF UNIT INSTALLATION LOCATION MUST PREVENT UNAUTHORIZED ACCESS BY UNATTENDED CHILDREN.**

## DELIVERY SET

Name	Number
Air handling unit	1 item
Fastening kit	1 item
Cardboard template	1 item
User's manual	1 item
Packing box	1 item

## DESIGNATION KEY

**MICRA 80 AX**

- **Unit control panel**  
3 - P3-1-300 control panel  
4 - SP3-1 control panel
- **Air capacity [m<sup>3</sup>/h]**
- **Unit name**

## TECHNICAL DATA

The unit is designed for indoor application with the ambient temperature ranging from +1 °C up to +40 °C and relative humidity up to 80 %.  
The transported air temperature range is from -25 °C up to +50 °C.

The unit is rated as a Class I electrical appliance.

Hazardous parts access and water ingress protection rating:

- IP44 for the unit motors
- IP22 for the assembled unit connected to the air ducts

The unit design is constantly being improved, so some models may be slightly different from those ones described in this manual.

### OVERALL DIMENSIONS OF THE UNIT [MM]

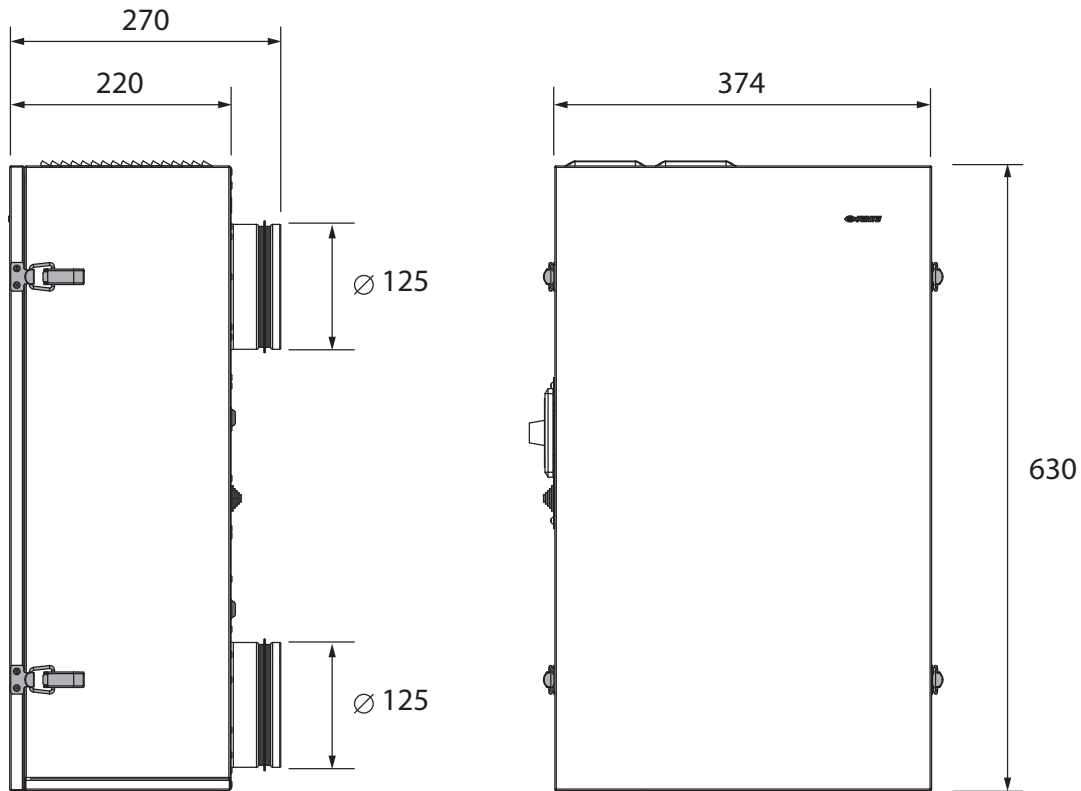

### UNIT TECHNICAL DATA

Speed	1	2	3
Voltage [V/50 Hz]	1 ~ 230		
Power [W]	25	35	57
Total unit current [A]	0.15	0.2	0.34
Air capacity [m <sup>3</sup> /h]	40	60	80
Noise level [dBA]	24	32	41
Transported air temperature [°C]	from -25 up to +50		
Casing material	painted steel		
Insulation	15 mm, penofol* type C		
Filter:	exhaust	G4	
	supply	G4	
Connected air duct diameter [mm]	125		
Weight [kg]	17		
Heat recovery efficiency [%]	from 68 up to 77		
Heat exchanger type	cross flow		
Heat exchanger material	polymerized cellulose		

\* — vapour and thermal insulation barrier based on polyethylene foam covered with aluminum foil

## DESIGN AND OPERATING PRINCIPLE

- The unit casing is made of painted steel, internally filled with a layer of heat- and sound-insulating material.
- The cross flow plate heat exchanger, the supply and the extract fan are installed inside the unit.
- The front panel is installed on the latches to enable quick access for unit servicing.

### UNIT DESIGN

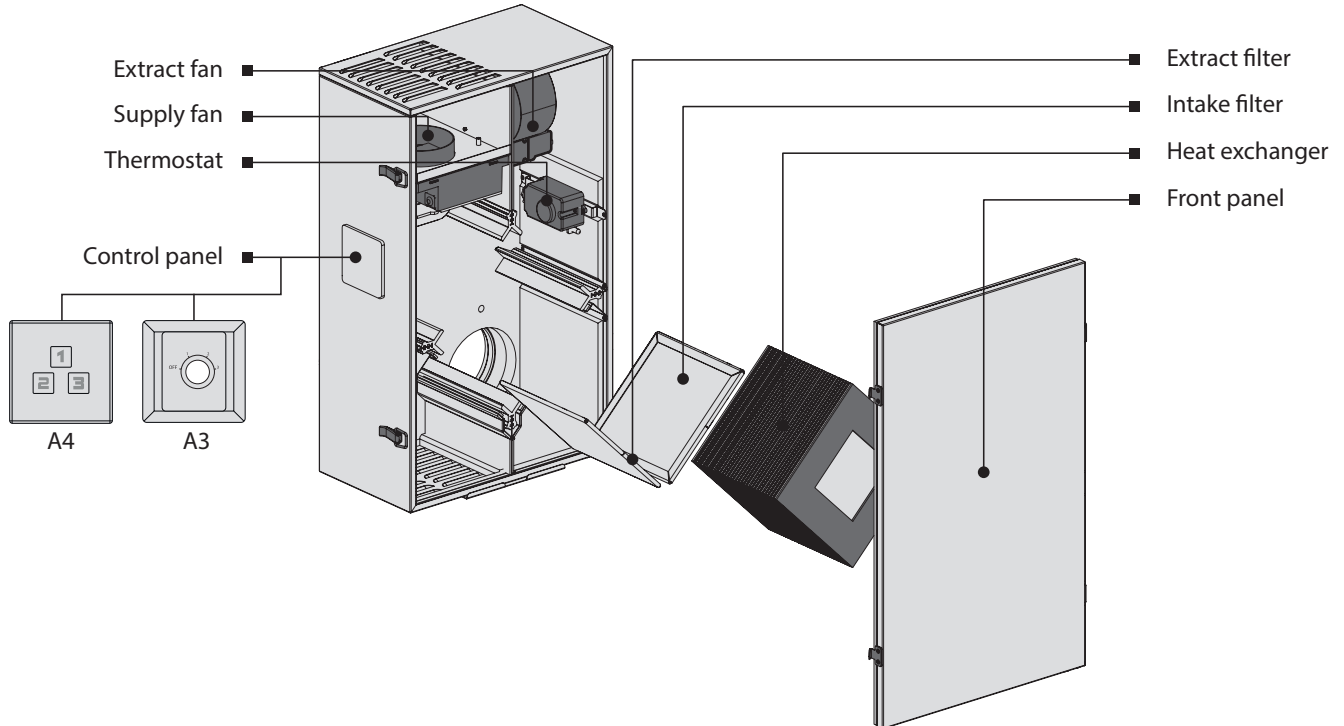

- If the exhaust air temperature falls down below  $+3\text{ }^{\circ}\text{C}$  the heat exchanger is subjected to the freezing danger. The freeze protection thermostat is installed in the exhaust air duct downstream of the heat exchanger. In case of a freezing danger the supply fan is turned off and the unit operates in air exhaust mode only. After the heat exchanger is warmed up and there is no freezing danger the unit reverts to the standard operation mode.

The unit has the following operating principle.

Warm stale extract air from the room flows to the unit, where it is filtered, then air flows through the heat exchanger and is exhausted outside by the extract fan. Clean cold air from outside is moved to the supply filter. Then filtered air flows through the heat exchanger and is moved to the room with the supply fan.

Heat energy of warm extract air is transferred to clean intake fresh air from outside and warms it up. Heat recovery minimizes thermal energy losses and space heating expenses in cold seasons.

The unit heat exchanger is able to recover not only heat energy but contained humidity thus maintaining indoor humidity level. In summer time the heat exchanger serves for supply air cooling and dehumidification and in winter time for its heating and moistening.

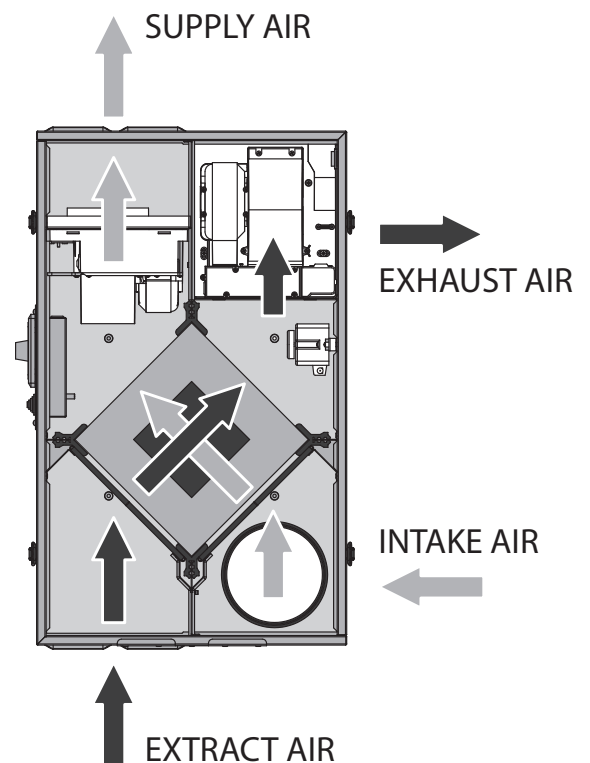

## MOUNTING AND SET-UP

Install the unit using the master plate from the scope of delivery and two  $\varnothing$  125 mm ducts of required length.

### CARDBOARD MASTER PLATE FOR HOLE MARKING, MM

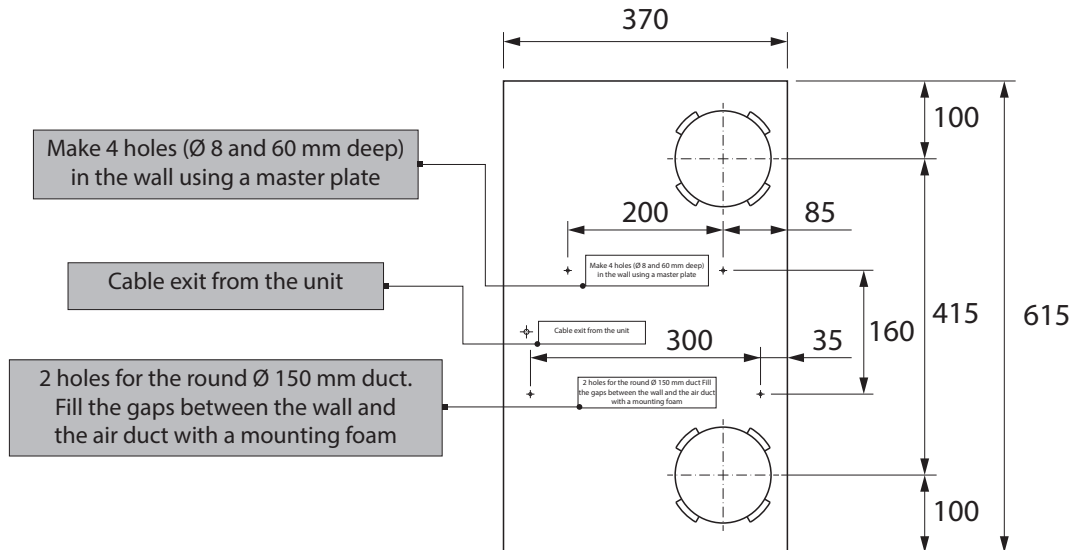

### UNIT MOUNTING

#### Unit mounting sequence:

1. Fix the master plate (included in the scope of delivery) to the wall at required level using adhesive tape.

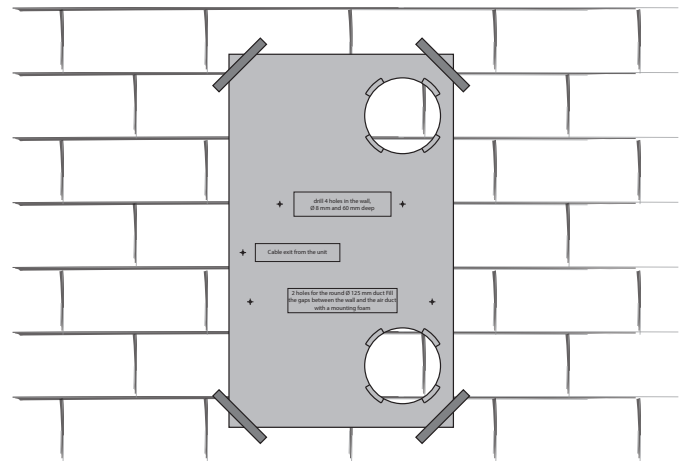

2. Use a master plate to mark two  $\varnothing$  150 mm holes for the air ducts and four  $\varnothing$  8 mm holes for the dowels.

3. Remove the master plate and drill through holes for the air ducts and the 60 mm deep holes for the dowels. The through holes for the air ducts must be sloped down by 2-3°. After that insert the dowels from the scope of delivery into the respective holes. While preparing the holes consider the method of laying the power cable. The cable exit from the unit is shown on the master plate.

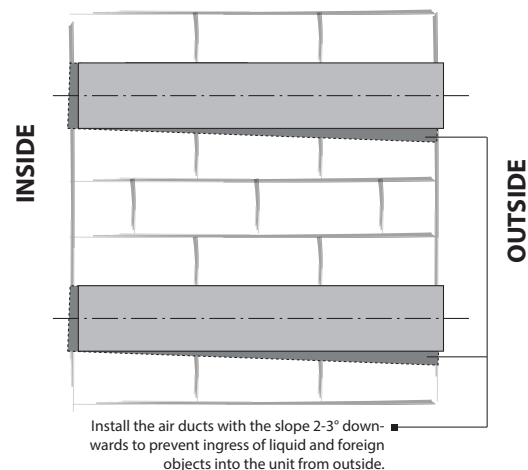
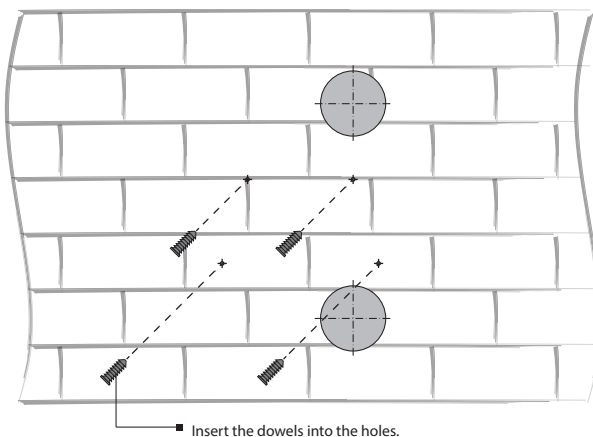



4. Using adhesive tape fix the master plate back in place.
5. Install the air ducts into the master plate holes and seal those with a mounting foam through the openings in the master plate. Install the air ducts sloped down by 2-3° to enable condensate drainage from the unit.
6. After the mounting foam hardening (see the solidification time in the product specification) remove the master plate and cut off the protruding parts of the air ducts to be flush with the outer and inner wall.

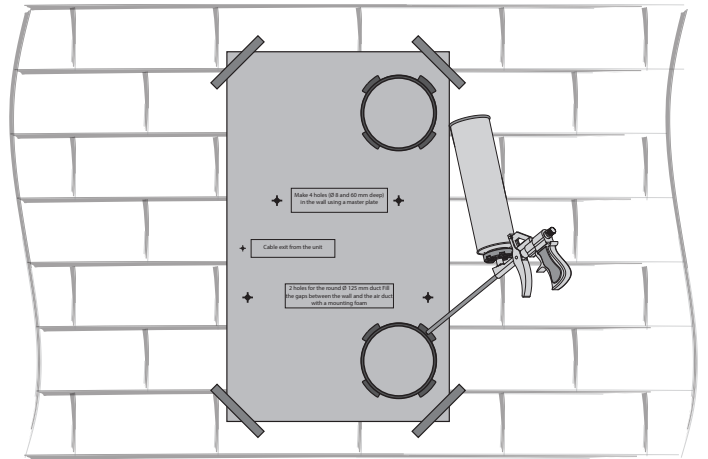

#### 7. Mounting sequence:

- Open the front panel and remove the heat exchanger.
- Connect the unit spigots to the plastic air ducts.
- Fix the unit to the wall installing the 5.0x50 screws from the scope of delivery into four Ø 8 mm holes.
- Install the heat exchanger and close the front panel.

**ATTENTION! The round air ducts and the outer ventilation hood are not included in the scope of delivery and are available separately.**

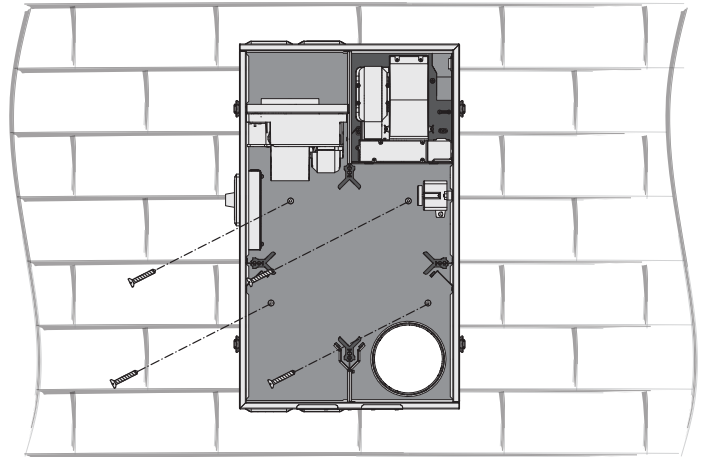

8. Install a Ø 125 mm outer ventilation hood on the outer wall side to prevent ingress of large foreign objects into the air ducts. The outer hood is not included in the scope of delivery and is available separately.

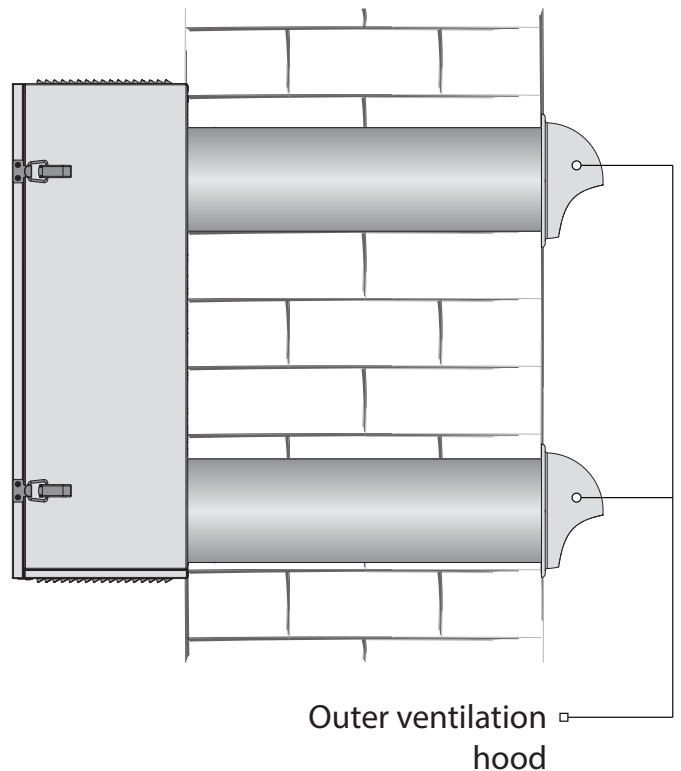

## CONNECTION TO POWER MAINS



**DISCONNECT THE UNIT FROM POWER MAINS PRIOR TO ANY OPERATIONS. CONNECT THE UNIT TO A PROPERLY INSTALLED SOCKET WITH A GROUNDED TERMINAL. ANY TAMPERING WITH THE INTERNAL CONNECTIONS IS PROHIBITED AND WILL VOID THE WARRANTY.**

The unit is rated for connection to single-phase AC power mains 1~230 V/50 Hz. For this purpose the power cable with a plug is connected by the Manufacturer.

Connect the unit to power mains through the external automatic circuit breaker with a magnetic trip integrated into the fixed wiring system. The trip current must correspond to the current consumption.

### WIRING DIAGRAM OF THE A3 CONTROL PANEL

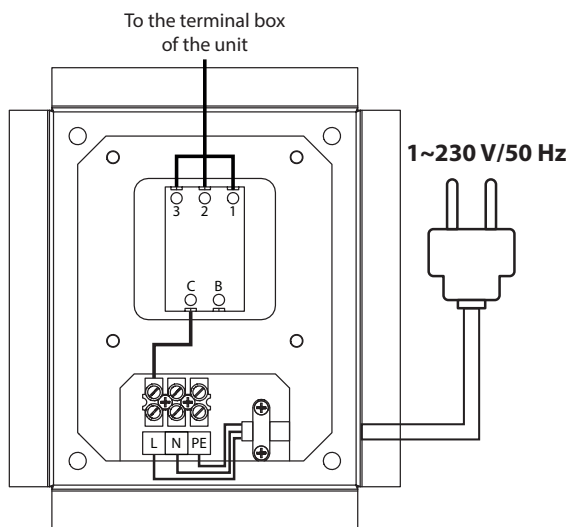

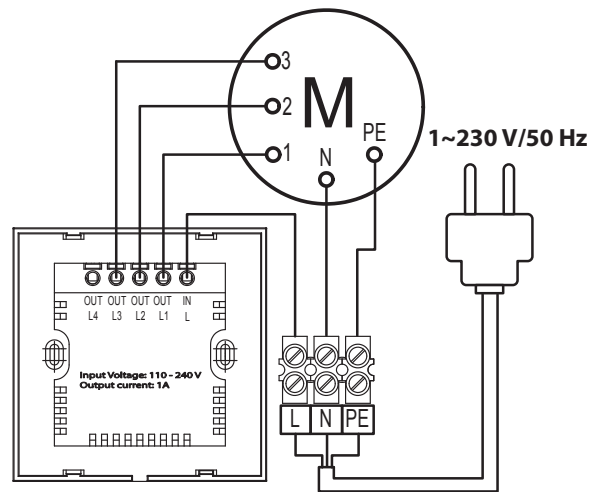

### WIRING DIAGRAM OF THE A4 CONTROL PANEL



## UNIT CONTROL

The unit is controlled via the A3 or A4 sensor control panel, depending on the model. The control panels are located on the unit back panel. The A3/A4 control panel is included in the scope of delivery.

UNIT CONTROL VIA THE A3 CONTROL PANEL	UNIT CONTROL VIA THE A4 CONTROL PANEL
<p>To activate a required unit speed rotate the speed knob clockwise and select one of three speed settings:</p> <ul style="list-style-type: none"> <li>1 – first speed</li> <li>2 – second speed</li> <li>3 – third speed</li> </ul> <p>To turn the unit off rotate the speed knob counter clockwise and set it to OFF position.</p>	<p>To activate a required unit speed touch a respective speed button on the sensor panel:</p> <ul style="list-style-type: none"> <li> –first speed</li> <li> –second speed</li> <li> –third speed</li> </ul> <p>To change speed press a respective speed button. To turn the unit off press the current speed button again. The activated speed button glows blue.</p>

## TECHNICAL MAINTENANCE

Maintenance operations of the unit are required 3-4 times per year. Maintenance includes general cleaning of the unit and the following operations:

### 1. Filter maintenance (3-4 times per year).

Clogged filters increase air resistance in the system and reduce supply air volume. The filters require cleaning not less than 3-4 times per year. Vacuum cleaning is allowed. After two cleanings filters must be replaced. For new filters contact the Seller.

Sequence of filter removal:

1. Lift the service panel latches.
2. Open or remove the service panel. Remove the panel with care.
3. Remove the filters from the unit.

### 2. Heat exchanger inspection (once per year).

Some dust may accumulate on the heat exchanger block even in case of regular maintenance of the filters. To maintain the high heat recovery efficiency, regular cleaning is required. To clean the heat exchanger remove it from the unit and clean the heat exchanger by using compressed air or a vacuum cleaner.

Sequence of heat exchanger removal:

1. Lift the service panel latches.
2. Open or remove the panel carefully, supporting it with the hand. Remove the panel with care.
3. Remove the heat exchanger.

### 3. Fan inspection (once per year).

Even in case of regular maintenance of the filters, some dust may accumulate inside the fans and reduce the fan performance and supply air flow.

Clean the fans with a soft cloth or brush. Do not use water, aggressive solvents or sharp objects as they may damage the impeller.

### 4. Exhaust louver shutters and intake diffusers cleaning.

Wash the diffusers and the louver shutters with warm detergent solution. Exhaust louver shutters and intake diffusers cleaning (as required).

### 5. Supply air flow control (twice per year).

The supply duct grille may get clogged with leaves and other objects reducing the unit performance and supply air delivery. Check the supply grille twice per year and clean it as required.

### 6. Ductwork system inspection (once in 5 years).

Even regular fulfilling of all the maintenance operations described above may not completely prevent dirt accumulation in the air ducts which reduces the unit capacity. Duct maintenance means regular cleaning or replacement.

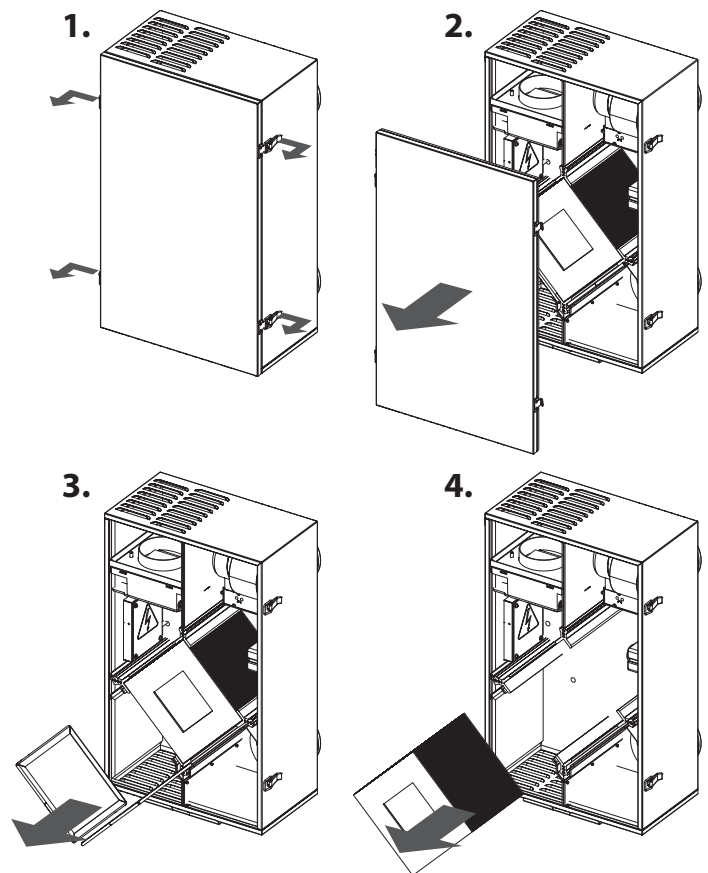

## TROUBLESHOOTING

### POSSIBLE REASONS AND TROUBLESHOOTING

Problem	Possible reasons	Troubleshooting
The fan(s) do(es) no start.	No power supply.	Make sure the power supply line is connected correctly, otherwise troubleshoot a connection error.
	The motor is jammed, the impeller blades are clogged.	Turn the unit off. Troubleshoot the motor jamming. Clean the blades. Restart the unit.
Automatic circuit breaker tripping following the unit turning on.	Overcurrent as a result of short circuit in the electric line.	Turn the unit off. Contact the Seller.
Low air flow.	Low set fan speed.	Set higher speed.
	The filters and the fans are clogged, the heat exchanger is clogged.	Clean or replace the filters, clean the fans and the heat exchanger.
	The ventilation system components (air ducts, diffusers, louver shutters, grilles) are clogged or damaged.	Clean or replace the ventilation system components (air ducts, diffusers, louver shutters, grilles).
Cold supply air.	The extract filter is soiled.	Clean or replace the extract filter.
	The heat exchanger is frozen.	Check the heat exchanger condition. Turn the unit off if required and restart it when freezing danger is past.
Noise, vibration.	The impeller(s) is soiled.	Clean the impeller(s).
	The fan or casing screw connection is loose.	Tighten the screw connection of the fans or the casing against stop.
	No anti-vibration connectors.	Install anti-vibration connectors.

## STORAGE AND TRANSPORTATION REGULATIONS

Store the unit in the manufacturer's original packing box in a dry closed ventilated premise with temperature range from +5 °C to + 40 °C. Storage environment must not contain aggressive vapours and chemical mixtures provoking corrosion, insulation and sealing deformation. Use hoist machinery for handling and transportation to prevent possible mechanical damages of the unit.

Follow the handling requirements applicable for the particular type of cargo.

The unit can be carried in the original packing by any mode of transport provided proper protection against precipitation and mechanical damage.

Avoid sharp blows, scratches or rough handling during loading and unloading.

## MANUFACTURER'S WARRANTY

The manufacturer hereby warrants normal operation of the unit for 24 months after the retail sale date provided the user's observance of the transportation, storage, mounting and operation regulations.

Should any malfunctions occur in the course of the unit operation through the Manufacturer's fault during the guaranteed period of operation the user is entitled to elimination of faults by the manufacturer by means of warranty repair at the factory free of charge.

The warranty repair includes work specific to elimination of faults in the unit operation to ensure its intended use by the user within the warranty period.

The faults are eliminated by means of replacement or repair of the complete unit or the faulty part thereof.

**The warranty repair does not include:**

- routine technical maintenance
- unit installation / dismantling
- unit setup

To benefit from warranty repair the user must provide the unit, the user's manual with the purchase date stamp and the payment document certifying the purchase.

The unit model must comply with the one stated in the user's manual.

**Contact the Seller for warranty service.**

**The manufacturer's warranty does not apply to the following cases:**

- user's failure to provide the unit with the entire delivery package as stated in the user's manual or with missing component parts previously dismantled by the user
- mismatch of the unit model and make with the respective details stated on the unit packing and in the user's manual
- user's failure to ensure timely technical maintenance of the unit
- external damage to the casing (excluding external modifications of the unit as required for its installation) and the internal components of the unit
- alteration of the unit design or engineering changes of the unit
- replacement and use of the unit assemblies, parts and components not approved by the manufacturer;
- unit misuse
- user's violation of the unit installation regulations
- user's violation of the unit management regulations
- unit connection to the power mains with a voltage different from the one stated in the user's manual
- unit breakdown due to voltage surges in the power mains
- user's discretionary repair of the unit
- unit repair performed by any persons not authorized by the manufacturer
- expiry of the unit warranty period
- user's violation of the established regulations specific to the unit transportation
- user's violation of the unit storage regulations
- wrongful acts against the unit committed by third persons
- unit breakdown due to circumstances of insuperable force (fire, flood, earthquake, war, hostilities of any kind, or blockade)
- missing seals if provided by the user's manual
- failure to submit the user's manual with the unit purchase date stamp
- missing payment document certifying the unit purchase



FOLLOWING THE REGULATIONS STIPULATED HEREIN WILL ENSURE A LONG AND TROUBLE-FREE OPERATION OF THE UNIT.



USER'S CLAIMS SHALL BE A SUBJECT TO REVIEW ONLY UPON PRESENTATION OF THE UNIT, THE PAYMENT DOCUMENT AND THE USER'S MANUAL WITH THE SALE DATE STAMP.

## ACCEPTANCE CERTIFICATE

<b>Unit Type</b>	Energy recovery air handling unit
<b>Model</b>	MICRA 80
<b>Serial Number</b>	
<b>Manufacture Date</b>	
We hereby declare that the product complies with the essential protection requirements of Electromagnetic Council Directive 2004/108/EC, 89/336/EEC and Low Voltage Directive 2006/95/EC, 73/23/EEC and CE-marking Directive 93/68/EEC on the approximation of the laws of the Member States relating to electromagnetic compatibility. This certificate is issued following test carried out on samples of the product referred to above.	
<b>Quality Inspector's Stamp</b>	

## SELLER INFORMATION

<b>Seller</b>	
<b>Address</b>	
<b>Phone Number</b>	
<b>E-mail</b>	
<b>Purchase Date</b>	
This is to certify delivery of the complete unit with the user's manual.	
<b>Customer's Signature</b>	

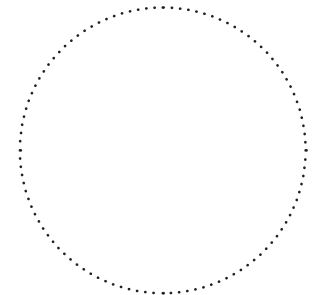

Seller's Stamp

## INSTALLATION CERTIFICATE

The MICRA 80 energy recovery air handling unit has been connected to power mains pursuant to the requirements stated in the present user's manual.	
<b>Company Name</b>	
<b>Address</b>	
<b>Phone Number</b>	
<b>Installation Technician's Full Name</b>	
<b>Installation Date:</b>	<b>Signature:</b>

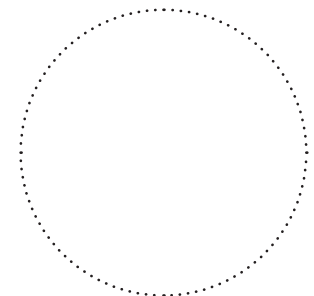

Installation Company Stamp

The unit has been installed in accordance with the provisions of all the applicable local and national construction, electrical and technical codes and standards. The unit operates normally as intended by the manufacturer.	
<b>Signature:</b>	

**WARRANTY CARD**

<b>Unit Type</b>	Energy recovery air handling unit
<b>Model</b>	MICRA 80
<b>Serial Number</b>	
<b>Manufacture Date</b>	
<b>Purchase Date</b>	
<b>Warranty Period</b>	
<b>Seller</b>	

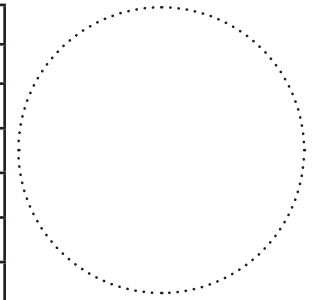

Seller's Stamp

A large rectangular area with a light gray border, containing ten horizontal lines for handwritten notes. A small circular logo is located in the bottom right corner of this area.



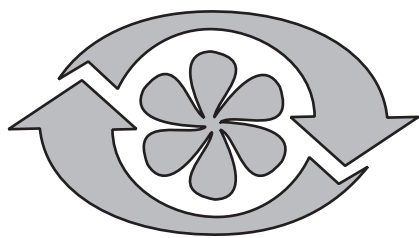

**IVECO**