

EN

SPEED CONTROLLER
User's manual



RS-...-TA



CONTENTS

Purpose.....	2
Delivery set.....	2
Technical data.....	3
Design and operating principle.....	8
Mounting and set-up.....	8
Troubleshooting.....	18
Storage and transportation regulations.....	19

PURPOSE

The device is intended for use in ventilation systems for switching on/off and controlling rotation speed of single-phase electric motors in power-controlled fans.

It is possible to control several fans if the total current consumption does not exceed the maximum allowable value of the controller current.

DELIVERY SET

Speed controller	1 pc.
User's manual	1 pc.
Packaging	1 pc.

TECHNICAL DATA

Main technical parameters	RS-3/0-TA	RS-6/0-TA	RS-10/0-TA
Supply voltage [V/50 (60) Hz]	~220–240		
Minimum current [A]	0,3	0,5	1
Maximum current [A]	3	6	10
Fuse rating [A]	F 5,0 A H 250 VAC	F 10,0 A H 250 VAC	F 16,0 A H 250 VAC
Maximum ambient temperature [°C]	-20 ... 40 °C at < 95% relative humidity (without condensation)		
Casing material	Plastic R-ABS		
Ingress Protection Rating	IP54		
Weight [kg]	0,84	1,0	1,08

Technical data

Analog input:

- voltage: 0-10 VDC / 10-0 VDC;
- current: 0-20 mA / 20-0 mA.

Analog input modes: acceleration or deceleration.

Analog input functionality:

Normal mode / Logic mode.

Remote control input:

Timer or Normal mode.

Adjustable output: 30–100 % Us.

Max. output load: depends on the version.

Unregulated output, L1: 230 VAC (50 / 60 Hz) / max. 2 A.

Min. output voltage, U_{min}: 30-70% U_s (69-161 VAC),

selectable via trimmer or via Modbus.

Max. output voltage, U_{max}: 75-100 % U_s (175-230 VAC),

selectable via trimmer or via Modbus.

The shutdown level is regulated by the trimmer:

- 0–4 VDC / 0–8 mA for the acceleration mode;
- 10-6 VDC / 20-12 mA for the deceleration mode.

Fast Start or Normal Start mode.

Low voltage output: +12 VDC / 1 mA for external potentiometer.

Modbus RTU

Indication of operation:

- continuous green: normal operating mode;
- flashing green: in standby mode.

Excess voltage and overload protection.

OPERATION DIAGRAM

Normal / remote operation modes

Acceleration mode

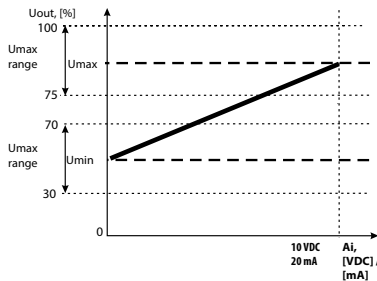

Calculation formula for acceleration mode

$$U_{out} = U_{min} + \frac{A_i}{A_{imax}} (U_{max} - U_{min})$$

Deceleration mode

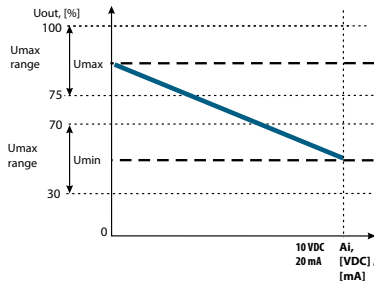

Calculation formula for deceleration mode

$$U_{out} = U_{max} - \frac{A_i}{A_{imax}} (U_{max} - U_{min})$$

Fast start of switching on

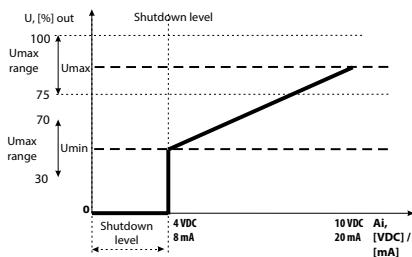

Calculation formula for acceleration mode

$$U_{out} = U_{min} + \frac{A_i - \text{Off level}}{A_{imax} - \text{Off level}} (U_{max} - U_{min})$$

Calculation formula for deceleration mode

$$U_{out} = U_{max} - \frac{A_i - \text{Off level}}{A_{imax} - \text{Off level}} (U_{max} - U_{min})$$

Smooth start of power on

Normal / remote operation modes

Acceleration mode

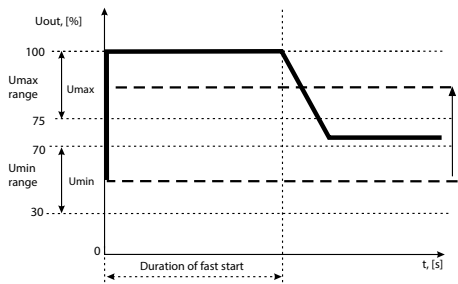

Deceleration mode

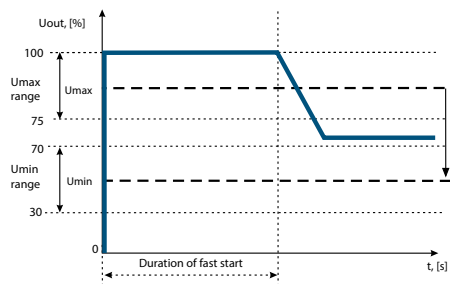

Smooth start and activated shutdown level

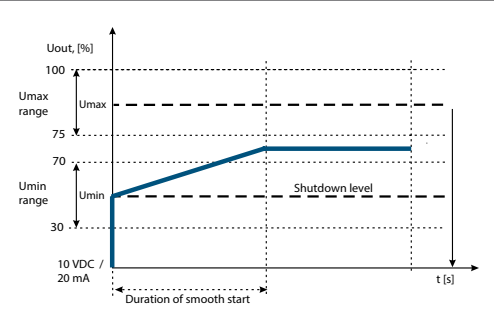
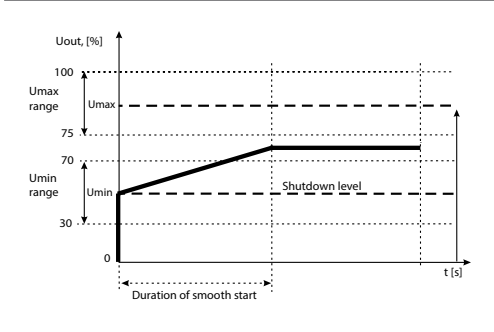

Fast mode and activated shutdown level

Normal / remote operation modes

Acceleration mode

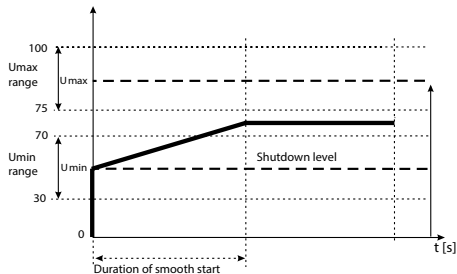

Deceleration mode

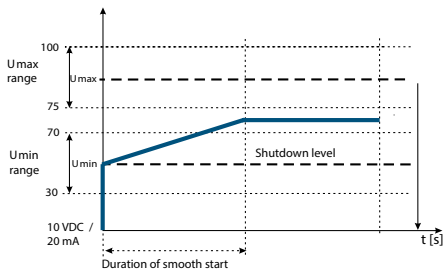

Smooth start and activated level off

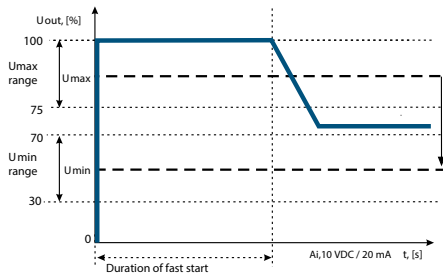
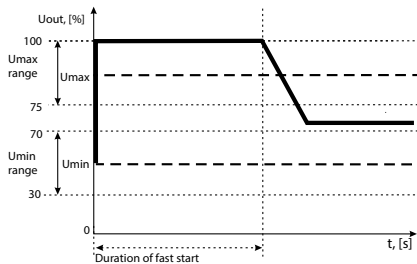

Fast mode and activated level off

Timer mode Logic mode

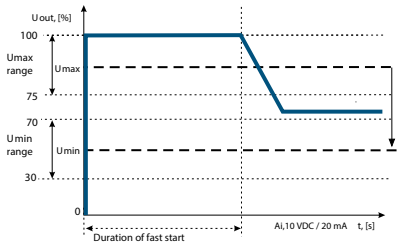

Switch signal

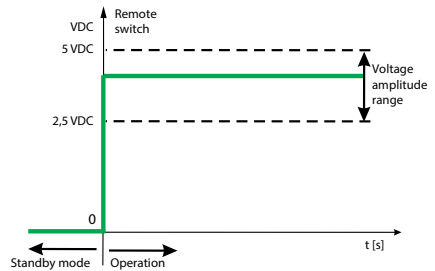

Fast start is enabled

Smooth start is enabled

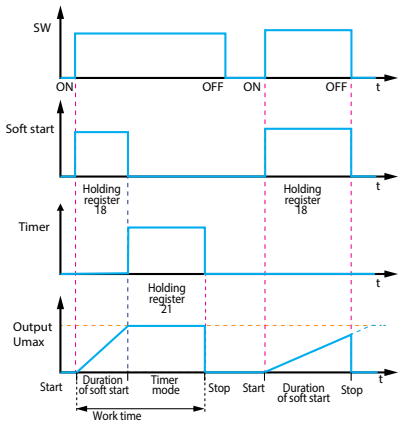

Switch signal

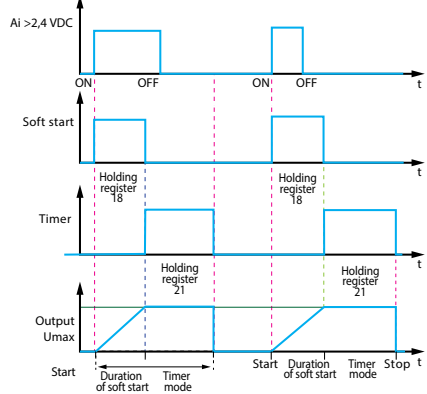

Ai control signal

DESIGN AND OPERATING PRINCIPLE

Controller casing is made of non-flammable thermoplastic.

The controller is equipped with an on/off button with backlight and an operation status indicator.

Output power change from 30 to 100% is made proportionally to the control signal 0...10 V or 4-20 mA in the selected range during configuring the controller.

The control signal type 0...10 V or 4-20 mA is selected by a switch in the controller casing.

Controlling is possible with the use of a remote control panel, e.g. the R-1/010 controller.

The minimum rotation speed value is set by a variable resistor on the control circuit board inside the controller.

The controller has an additional terminal (230 V) for connecting and controlling external equipment (for example, air damper drives).

The input circuit of the controller is protected from voltage and current overload by a fuse.

MOUNTING AND SET-UP

The controller is intended for indoor installation.

When installing the controller ensure unobstructed recirculation of air for cooling its internal elements.

Do not install the controller above heating equipment or in areas with insufficient air convection.

ATTENTION! After transporting or storing the product at sub-zero temperatures the controller must be kept under the specified operating conditions for at least 4 hours prior to turning it on.

Inspect the product visually to confirm absence of any damage to the controller casing.

An automatic switch built into the stationary power supply network must be installed on the external input.

Note: To disable the ON / OFF function (3.0 A version only!) connect 230 VAC supply voltage to the unregulated output (L1). In this case, do not connect the power supply unit to L.

INSTALLATION INSTRUCTIONS

Find a flat surface for mounting (wall, panel, etc.).

Follow these steps:

1. Turn off the power.
2. Remove the front cover by removing the self-tapping screws and secure the controller to the wall or panel using screws through holes located in the back wall of the device. Observe the correct mounting position and dimensions of the device. (See Fig. 1: Mounting dimensions and Fig. 2: Mounting position.)

Fig. 1. Dimensions [mm]

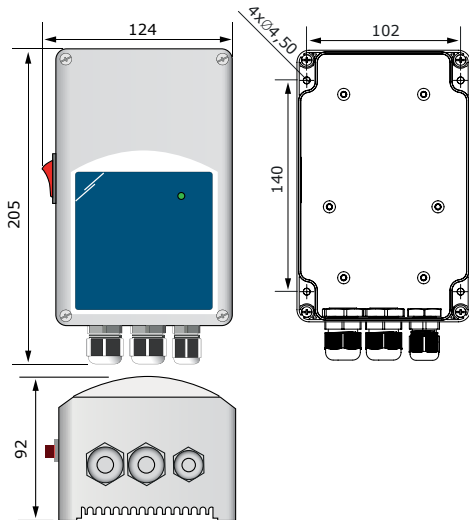
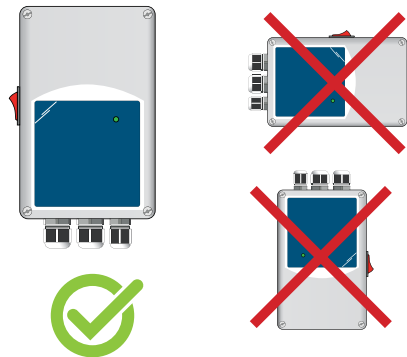
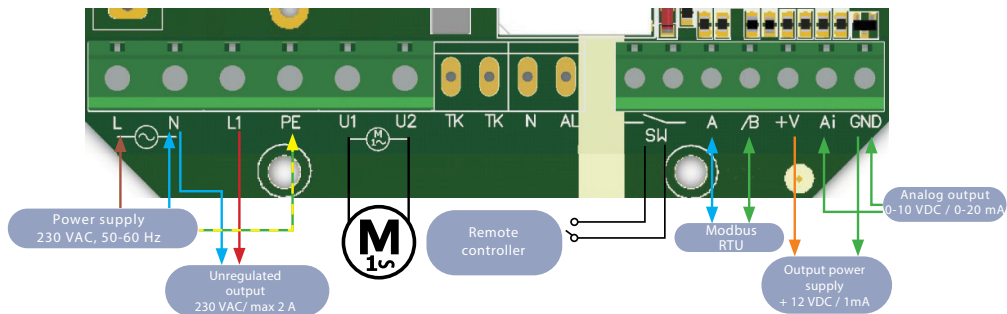

Fig. 2. Mounting position



3. Connect the motor / fan. The connection is made using screw terminals on the controller circuit board.
4. Connect L1 output for three-wire connection, adjustable valve, etc. (if necessary). See Fig. 3.

Figure 3. Electrical circuit diagram



WIRING AND CONNECTING

L	Supply voltage [230 VAC/50(60) Hz]
N	Neutral
PE	Ground terminal
L1	Unregulated output (230 V/max. 2 A)
U1, U2	Adjustable output for motor connection
SW	Remote switch/timer switch
A	Modbus RTU (RS485), signal A
/B	Modbus RTU (RS485), /B signal
+V	Power supply output +12 VDC/1 mA
Ai	Analog input 0-10 V/0-20 mA (10-0 V/20-0 mA) / input in Logic mode (timer function)
GND	Grounding

5. Select the desired analog input type and mode, start mode and shutdown level using the DIP switch on the circuit board. (See Fig. 4.).

Figure 4. Setting the DIP switch

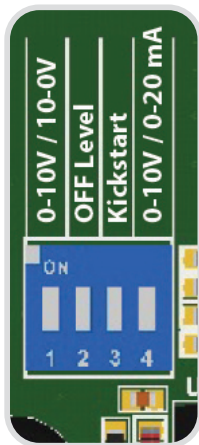

Acceleration/deceleration mode selection (DIP switch, position 1)		ON — deceleration mode: 10-0 VDC / 20-0 mA
		OFF — acceleration mode: 0-10 VDC / 0-20 mA
OFF level selection (DIP switch position 2)		ON - enabled
		OFF - disabled
Fast / smooth start selection (DIP switch, position 3)		ON - fast start
		OFF - smooth start
Input mode selection (DIP switch, position 4)		ON - current mode (0-20 mA)
		OFF - voltage mode (0-10 VDC)

6. A network bus terminator (NBT) is used to set the device as a terminator, and by default the NBT is disabled. It is installed manually on the pins that need to be connected (see Fig. 5). To ensure correct communication, the NBT jumper must be activated only in two devices in the Modbus RTU network (see example 1 and example 2).

Example 1

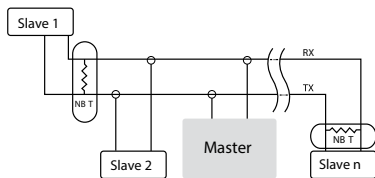

Example 2

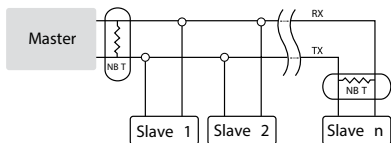

Figure 5. Mains bus resistor jumper



ATTENTION! Network bus terminators (NBTs) must be activated in the Modbus RTU network.

ATTENTION! If an AC power supply is used with a device in a Modbus network, DO NOT connect the GND terminal to other network devices or via a CNVT-USB-RS485 converter. This can lead to permanent damage to the communication semiconductors and/or the computer!

7. Connect the power supply.
8. Adjust the max. speed using the trimmer (if necessary).
The default setting is U_s (230 VAC), see Fig. 6.
9. Adjust the min. speed using the trimmer (if necessary).
Default is 30 % U_s (69 VAC), see Fig. 7.
10. Adjust the off level value on the trimmer (if necessary).
The default value is 0 VAC, see Fig. 8.

Fig. 6. Max. speed trimmer

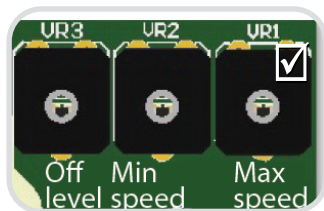

Fig. 7. Trimmer for min. speed

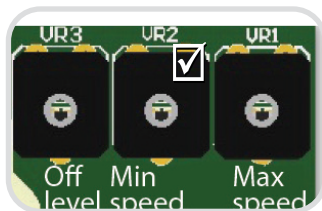
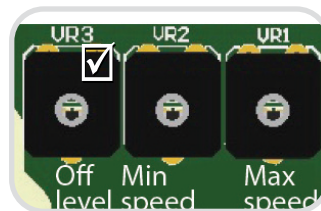

Fig. 8. Trimmer for setting the off level



11. Close the housing and secure the cover.
12. Switch on the power supply.
13. Change the factory settings to the desired ones using 3SModbus software (if necessary).

Follow the instructions below:

1. Turn on the power.
2. Set the NBT jumper, DIP switch, max. speed trimmer, trimmer for min. speed and the off level trimmer to the desired positions / values.

Factory settings are as follows:

- the jumper is open (the mains bus resistor jumper is disconnected);
- acceleration mode: 0–10 VDC / 0–20 mA;
- OFF level;
- fast start is disabled;
- input voltage mode (0–10 VDC);
- min. settings on the trimmer for min. speed;
- max. settings on the max. speed trimmer;
- min. setting on the off level trimmer.

3. Set the analog input signal to a maximum value of 10 VDC or 20 mA.

4. The connected motor will run at a maximum or minimum speed depending on the analog input mode (acceleration / deceleration).

5. If shutdown level is enabled and the deceleration analog input mode is selected, the motor will stop running.

6. Set the analog input signal to the maximum value of 0 VDC or 0 mA.

7. The connected fan will run at a minimum or maximum speed depending on the analog input mode (acceleration / deceleration).

8. If the shutdown level is enabled and the acceleration analog input mode is selected, the motor will stop running.

9. If the shutdown level and the input signal are equal to the shutdown level value, the motor speed will be minimal in the acceleration mode or maximum in the deceleration mode.

10. If the controller does not work according to the above instructions, it is necessary to check connections and settings.

11. Check whether both LEDs (Fig. 9) are lit after turning on the device. If lit, your device has detected a Modbus network. If not, check the connection.

Fig. 9. Communication detection indication

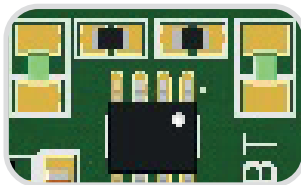

ATTENTION! The status of LEDs can only be checked when power is supplied to the device. Follow all necessary safety precautions!

OPERATING MANUAL

Operation modes

In Modbus mode you control the following parameters: Umax, Umin, fast start / smooth start, acceleration / deceleration and shutdown level values with Modbus registers.

In autonomous mode you control the following parameters: Umax, Umin, fast start / smooth start, acceleration / deceleration and shutdown level values with hardware settings (DIP switch, trimmers, jumpers).

In normal mode, if the shutdown level is disabled, smooth start / fast start is performed only once after the controller is powered up, otherwise smooth start / fast start is activated every time the controller is powered on.

When **Timer mode** is selected, the controller receives a pulse control signal from the remote control switch. When Logic mode is selected, the controller receives a pulse control signal from the Ai input.

In both modes — **Timer mode** and **Logic mode** — the pulse width must exceed 30 ms, otherwise the signal will be filtered.

LED indication on the front panel

When the green LED on the front panel (Fig. 10) is continuously lit, the controller is working in normal mode. If it flashes:

- the controller works in remote control mode, or
- the controller is turned off and the analog input signal is below the shutdown level.

Fig. 10: Indication of the operating status

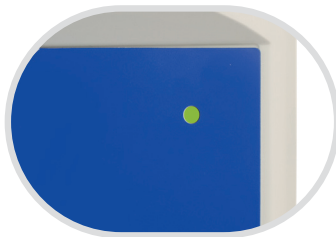

TROUBLESHOOTING

Trouble	Possible reasons	Troubleshooting
Device is not working.	Limited or no connection.	Check the correct connection to the electrical power mains.
	The fuse has failed.	Replace the fuse.
Fan is not rotating when the controller is on.	Minimum fan rotation speed is set incorrectly.	Adjust the minimum fan rotation speed.

STORAGE AND TRANSPORTATION REGULATIONS

- Store the unit in the manufacturer's original packaging box in a dry closed ventilated premise with temperature range from +5 °C to + 40 °C and relative humidity up to 70 %.
- Storage environment must not contain aggressive vapors and chemical mixtures provoking corrosion, insulation, and sealing deformation.
- Use suitable hoist machinery for handling and storage operations to prevent possible damage to the unit.
- Follow the handling requirements applicable for the particular type of cargo.
- The unit can be carried in the original packaging by any mode of transport provided proper protection against precipitation and mechanical damage. The unit must be transported only in the working position.
- Avoid sharp blows, scratches, or rough handling during loading and unloading.
- Prior to the initial power-up after transportation at low temperatures, allow the unit to warm up at operating temperature for at least 3-4 hours.

Certificate of acceptance

RS _____ **TA**

The unit is recognized as serviceable.