

# USER'S MANUAL

---

**VKMz 100 Q**  
**VKMz 100**  
**VKMz 125 Q**  
**VKMz 125**

**VKMz 150**  
**VKMz 160**  
**VKMz 200 Q**  
**VKMz 200**

**VKMz 250 Q**  
**VKMz 250**  
**VKMz 315 Q**  
**VKMz 315**



Centrifugal inline fan

## CONTENTS

Contents.....	2
Safety requirements.....	2
Purpose.....	4
Delivery set.....	4
Designation key.....	4
Technical data.....	5
Design and operating principle .....	6
Mounting and set-up.....	6
Connection to power mains .....	7
Technical maintenance.....	8
Storage and transportation regulations.....	8
Manufacturer's warranty .....	9
Certificate of acceptance.....	11
Seller information.....	11
Installation certificate.....	11
Warranty card.....	11

This user's manual is the primary operating document intended for technical, maintenance and operations staff.

The user's manual contains information regarding the field of application, delivery package, operating principle, and design of the VKMz fan and all its modifications.

Technical and maintenance staff must have proper theoretical knowledge and practical training specific to ventilation systems as well as the necessary skills to carry out the work in accordance with labour safety and construction regulations and standards applicable in the respective territory.

The information provided in the present document is true as at the document preparation.

Due to the continuous product development the company reserves the right to update the technical specifications, design or delivery package of its products.

No part of the present publication may be reproduced, uploaded or saved in reference-providing information systems or translated into other languages in any form whatsoever without the company's prior written consent.

## SAFETY REQUIREMENTS

- Please read the user's manual carefully prior to installing and operating the unit.
- All user's manual requirements as well as the provisions of all the applicable local and national construction, electrical, and technical norms and standards must be observed when installing and operating the unit.
- The warnings contained in the user's manual must be considered most seriously since they contain vital personal safety information.
- Failure to follow the rules and safety precautions noted in this user's manual may result in an injury or unit damage.
- After a careful reading of the manual, keep it for the entire service life of the unit.
- While transferring the unit control, the user's manual must be turned over to the receiving operator.

### UNIT INSTALLATION AND OPERATION SAFETY PRECAUTIONS



- Disconnect the unit from power mains prior to any installation operations.



- Unpack the unit with care.



- The unit must be grounded!



- While installing the unit, follow the safety regulations specific to the use of electric tools.



- Do not change the power cable length at your own discretion. Do not bend the power cable. Avoid damaging the power cable. Do not put any foreign objects on the power cable.



- Do not use damaged equipment or cables when connecting the unit to power mains.



- Do not touch the unit controls with wet hands. Do not carry out the installation and maintenance operations with wet hands.



- Do not allow children to operate the unit.



- Do not store any explosive or highly flammable substances in close proximity to the unit.



- Do not open the unit during operation.



- Do not block the air duct when the unit is switched on.

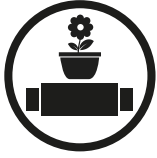

- Do not sit on the unit and avoid placing foreign objects on it.



- Do not lay the power cable of the unit in close proximity to heating equipment.



- Do not operate the unit outside the temperature range stated in the user's manual. Do not operate the unit in aggressive or explosive environments.



- Do not wash the unit with water. Protect the electric parts of the unit against ingress of water.



- Disconnect the unit from power mains prior to any technical maintenance.



- When the unit generates unusual sounds, odour, or emits smoke, disconnect it from power supply and contact the Seller.



- Do not direct the air flow produced by the unit towards open flame or ignition sources.



- In case of continuous operation of the unit, periodically check the security of mounting.



- Use the unit only for its intended purpose.



**THE PRODUCT MUST BE DISPOSED SEPARATELY AT THE END OF ITS SERVICE LIFE.  
DO NOT DISPOSE THE UNIT AS UNSORTED MUNICIPAL WASTE.**

## PURPOSE

The VENTS VKMz centrifugal fans are designed for ventilation of domestic, public and manufacturing premises heated during winter. The transported air temperature must be within the limits stated in the «Technical data» section.



**THE UNIT SHOULD NOT BE OPERATED BY CHILDREN OR PERSONS WITH REDUCED PHYSICAL, MENTAL, OR SENSORY CAPACITIES, OR THOSE WITHOUT THE APPROPRIATE TRAINING. THE UNIT MUST BE INSTALLED AND CONNECTED ONLY BY PROPERLY QUALIFIED PERSONNEL AFTER THE APPROPRIATE BRIEFING.**

**THE CHOICE OF UNIT INSTALLATION LOCATION MUST PREVENT UNAUTHORIZED ACCESS BY UNATTENDED CHILDREN.**



**THE UNIT MUST NOT BE OPERATED IN KITCHEN PREMISES.**

The fan is designed for horizontal or vertical mounting in an air duct and is used both for supply and exhaust ventilation. Transported air must not contain any flammable or explosive mixtures, evaporation of chemicals, sticky substances, fibrous materials, coarse dust, soot and oil particles or environments favourable for the formation of hazardous substances (toxic substances, dust, pathogenic germs).

## DELIVERY SET

NAME	NUMBER
Fan	1 pc.
Outer fixing bracket	2 pcs.
User's manual	1 pc.
Packing box	1 pc.

## DESIGNATION KEY

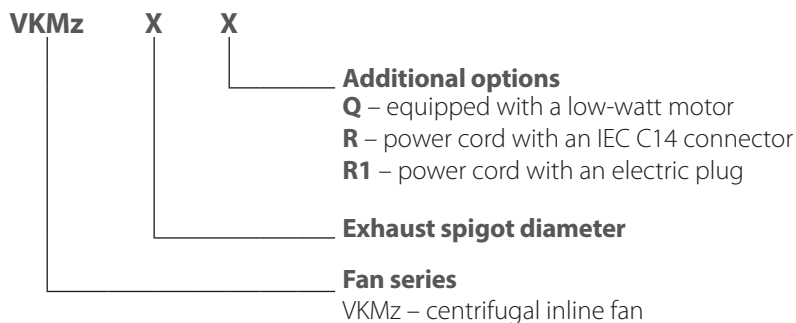

## TECHNICAL DATA

Permitted deviation of mains voltage:  $\pm 10\%$  of the rated voltage.

The fan must be grounded.

Ingress protection rating against access to hazardous parts and water ingress is IPX4.

Fan model	Voltage [V] at 50 Hz	Power [W]	Current [A]	Air flow [m <sup>3</sup> /h], max	RPM [min <sup>-1</sup> ]	Noise level at 3 m [dBA]	Transported air temperature [°C]
VKMz 100 Q	1~230	60	0.37	195	2670	35	-25 +55
VKMz 100		72	0.32	250	2820	46	
VKMz 125 Q		60	0.37	230	2605	35	
VKMz 125		78	0.34	330	2820	46	
VKMz 150		75	0.33	455	2770	46	
VKMz 160		78	0.34	455	2760	46	
VKMz 200 Q		139	0.61	840	2790	48	
VKMz 200		157	0.69	1000	2740	50	
VKMz 250 Q		134	0.59	980	2785	51	
VKMz 250		152	0.66	1070	2785	52	
VKMz 315 Q		151	0.66	1330	2680	52	
VKMz 315		185	0.81	1540	2730	53	

Fan model	Voltage [V] at 60 Hz	Power [W]	Current [A]	Air flow [m <sup>3</sup> /h], max	RPM [min <sup>-1</sup> ]	Noise level at 3 m [dBA]	Transported air temperature [°C]
VKMz 100 Q	1~230	61	0.37	204	2710	36	-25 +50
VKMz 100		77	0.33	285	2880	47	
VKMz 125 Q		61	0.37	240	2720	36	
VKMz 125		79	0.34	340	2880	46	
VKMz 150		81	0.35	480	2810	46	
VKMz 160		81	0.35	460	2820	46	
VKMz 200 Q		177	0.78	940	2850	49	
VKMz 200		202	0.88	1045	2840	50	
VKMz 250 Q		175	0.77	1030	2880	51	
VKMz 250		202	0.88	1100	2650	52	
VKMz 315 Q		205	0.89	1370	2750	52	
VKMz 315		238	1.04	1580	2870	54	

The unit design is constantly being improved, thus some models, their wiring diagrams and terminal symbols may be slightly different from those described in this manual.

### OVERALL AND CONNECTING DIMENSIONS

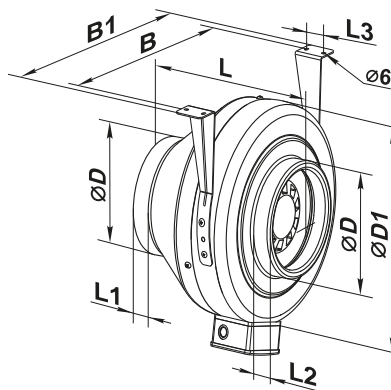

Model	Dimensions [mm]								Weight [kg]
	ØD	ØD1	B	B1	L	L1	L2	L3	
VKMz 100 Q	98	237	253	293	202	23	22	30	3,16
VKMz 100	98	237	253	293	202	23	22	30	3,16
VKMz 125 Q	123	237	253	293	202	23	22	30	3,16
VKMz 125	123	237	253	293	202	23	22	30	3,16
VKMz 150	148	278	294	334	200	25	23	30	3,42
VKMz 160	158	278	294	334	200	25	23	30	3,44
VKMz 200 Q	198	332	340	380	245	25	29	40	5,43
VKMz 200	198	332	340	380	245	25	29	40	5,43
VKMz 250 Q	249	332	340	380	213	25	29	40	5,25
VKMz 250	249	332	340	380	213	25	29	40	5,25
VKMz 315 Q	313	402	410	450	308	33	55	40	6,57
VKMz 315	313	402	410	450	308	33	55	40	6,57

## DESIGN AND OPERATING PRINCIPLE

The fan consists of the casing 1, the electric motor attached to the inner fixing bracket 4, the cover 2 that is fixed to the casing with screws 3 (the casing spigot diameter and the cover diameter are equal to the connected air duct diameter), the terminal box 5 that incorporates a terminal block and a capacitor and enables connection of the fan to single-phase power mains.

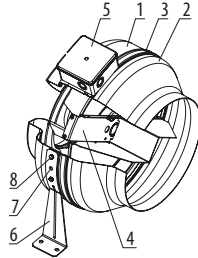

Fig. 1

- 6 – outer fixing bracket
- 7 – screws
- 8 – bolt

## MOUNTING AND SET-UP



**READ THE USER'S MANUAL BEFORE INSTALLING THE UNIT**

The fans are designed for vertical or horizontal mounting. Air motion in the system must be in compliance with the direction of the arrow on the fan casing. Install a hood on outlet (discharge) spigot side in case of the vertical fan installation. Provide a straight air duct section at least 1 m long on the intake spigot side in case of horizontal fan installation with maximum allowable humidity.

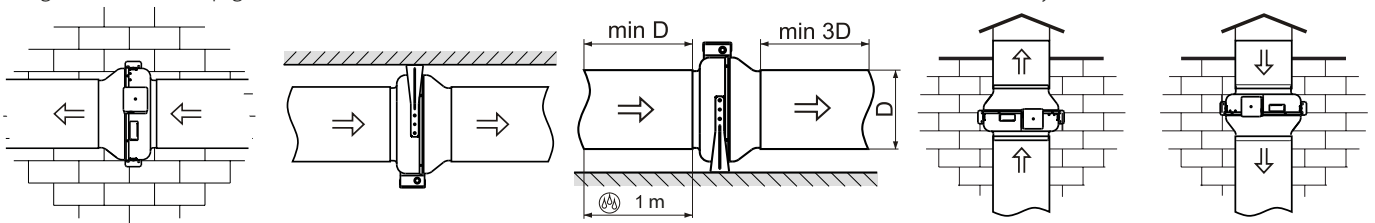

Mounting sequence:

- Remove the bolt from the casing 1 and install the fixing brackets in such a way so that the holes on the fixing brackets are aligned with the heads of the screws 3.
- Fix the fixing brackets on the casing with bolts.
- Drill the holes in the mounting surface to match the fitment holes of the fixing brackets.
- Fix the fan with the screws.
- Connect the air ducts of the respective size to the fan and fix them with clamps.

## CONNECTION TO POWER MAINS



**DISCONNECT THE POWER SUPPLY PRIOR TO ANY OPERATIONS WITH THE UNIT.  
CONNECTION OF THE UNIT TO POWER MAINS IS ALLOWED BY A QUALIFIED  
ELECTRICIAN WITH A WORK PERMIT FOR THE ELECTRIC UNITS UP TO 1000 V AFTER  
CAREFUL READING OF THE PRESENT USER'S MANUAL. THE RATED ELECTRICAL  
PARAMETERS OF THE UNIT ARE GIVEN ON THE MANUFACTURER'S LABEL.**



**ANY TAMPERING WITH THE INTERNAL CONNECTIONS IS PROHIBITED  
AND WILL VOID THE WARRANTY.**

The fan is designed for 230 V/50 (60) Hz single-phase alternating current mains.

The fan shall be connected to power supply by means of insulated, durable and thermal-resistant cords (cables, wires) through the external circuit breaker with a thermal-magnetic trip built into the stationary wiring to disconnect all the power mains phases.

The rated current must be not below the rated current consumption (refer to the «Technical data» section).

The QF external switch location must ensure free access for quick shutdown of the fan.

The recommended circuit breaker nominal current is 1 A.

The recommended wire cross section is 0.75 mm<sup>2</sup>.

The actual conductor cross-section selection must be based on its type, the maximum permissible heating, insulation, length and installation method (in the air, pipes or inside walls).

Connect the cables to the terminal block incorporated inside the terminal box located on the fan casing in compliance with the fan wiring diagram and the terminal designation.

The terminal designations are shown on the sticker inside the fan casing.

Fan wiring diagram:

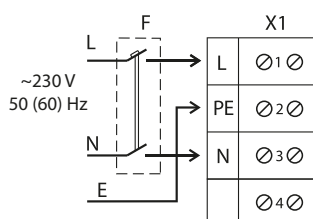

## TECHNICAL MAINTENANCE



**DISCONNECT THE UNIT FROM POWER SUPPLY BEFORE ANY MAINTENANCE OPERATIONS!**

The technical maintenance includes periodic cleaning of the surfaces from accumulated dust and dirt.

Use a soft dry brush or a vacuum cleaner to remove dust.

The impeller blades require thorough cleaning once in 6 months.

To do this, unscrew the self-tapping screws 3 and remove the cover 2 (Fig. 1).

Clean the impeller blades with a soft cloth wetted in mild water detergent solution. Avoid liquid dripping on the motor.

### POSSIBLE REASONS AND TROUBLESHOOTING

PROBLEM	POSSIBLE REASONS	TROUBLESHOOTING
When switching on the unit the fan does not start.	No power supply.	Check the electrical connections and the power switch status.
	Motor jamming.	Turn off the fan. Troubleshoot the impeller jamming. Restart the fan.
Circuit breaker tripping during the fan start.	The automatic circuit breaker is triggered by an abnormally high current consumption due to a short circuit.	«Disconnect the fan from power mains and contact the Seller. Do not turn on the fan again!»
Low air flow.	Clogging of air ducts or other ventilation system elements. Impeller clogging. Damaged air ducts. Air damper closure.	Clean the air ducts and other ventilation system elements as well as the impeller. Check the air ducts for damage. Make sure the air dampers and louvre shutters are open.

## STORAGE AND TRANSPORTATION REGULATIONS

- Store the unit in the manufacturer's original packaging box in a dry closed ventilated premise with temperature range from +5 °C to +40 °C and relative humidity up to 70 %.
- Storage environment must not contain aggressive vapours and chemical mixtures provoking corrosion, insulation, and sealing deformation.
- Use suitable hoist machinery for handling and storage operations to prevent possible damage to the unit.
- Follow the handling requirements applicable for the particular type of cargo.
- The unit can be carried in the original packaging by any mode of transport provided proper protection against precipitation and mechanical damage. The unit must be transported only in the working position.
- Avoid sharp blows, scratches, or rough handling during loading and unloading.
- Prior to the initial power-up after transportation at low temperatures allow the unit to warm up at room temperature for at least 3-4 hours.



## MANUFACTURER'S WARRANTY

The product is in compliance with EU norms and standards on low voltage guidelines and electromagnetic compatibility. We hereby declare that the product complies with the provisions of Electromagnetic Council Directive 2014/30/EU, Low Voltage Directive 2014/35/EU and CE-marking Directive 93/68/EEC. This certificate is issued following test carried out on samples of the product referred to above. The manufacturer hereby warrants normal operation of the unit for 24 months after the retail sale date provided the user's observance of the transportation, storage, installation, and operation regulations. Should any malfunctions occur in the course of the unit operation through the Manufacturer's fault during the guaranteed period of operation, the user is entitled to get all the faults eliminated by the manufacturer by means of warranty repair at the factory free of charge. The warranty repair includes work specific to elimination of faults in the unit operation to ensure its intended use by the user within the guaranteed period of operation. The faults are eliminated by means of replacement or repair of the unit components or a specific part of such unit component.

### The warranty repair does not include:

- routine technical maintenance
- unit installation/dismantling
- unit setup

To benefit from warranty repair, the user must provide the unit, the user's manual with the purchase date stamp, and the payment paperwork certifying the purchase. The unit model must comply with the one stated in the user's manual. Contact the Seller for warranty service.

### The manufacturer's warranty does not apply to the following cases:

- User's failure to submit the unit with the entire delivery package as stated in the user's manual including submission with missing component parts previously dismantled by the user.
- Mismatch of the unit model and the brand name with the information stated on the unit packaging and in the user's manual.
- User's failure to ensure timely technical maintenance of the unit.
- External damage to the unit casing (excluding external modifications as required for installation) and internal components caused by the user.
- Redesign or engineering changes to the unit.
- Replacement and use of any assemblies, parts and components not approved by the manufacturer.
- Unit misuse.
- Violation of the unit installation regulations by the user.
- Violation of the unit control regulations by the user.
- Unit connection to power mains with a voltage different from the one stated in the user's manual.
- Unit breakdown due to voltage surges in power mains.
- Discretionary repair of the unit by the user.
- Unit repair by any persons without the manufacturer's authorization.
- Expiration of the unit warranty period.
- Violation of the unit transportation regulations by the user.
- Violation of the unit storage regulations by the user.
- Wrongful actions against the unit committed by third parties.
- Unit breakdown due to circumstances of insuperable force (fire, flood, earthquake, war, hostilities of any kind, blockades).
- Missing seals if provided by the user's manual.
- Failure to submit the user's manual with the unit purchase date stamp.
- Missing payment paperwork certifying the unit purchase.



**FOLLOWING THE REGULATIONS STIPULATED HEREIN WILL ENSURE A LONG AND TROUBLE-FREE OPERATION OF THE UNIT.**



**USER'S WARRANTY CLAIMS SHALL BE SUBJECT TO REVIEW ONLY UPON PRESENTATION OF THE UNIT, THE PAYMENT DOCUMENT AND THE USER'S MANUAL WITH THE PURCHASE DATE STAMP.**



### Certificate of acceptance

<b>Unit Type</b>	Centrifugal inline fan
<b>Model</b>	VKMz____
<b>Serial Number</b>	
<b>Manufacture Date</b>	
<b>Quality Inspector's Stamp</b>	

### Seller information

<b>Seller</b>	
<b>Address</b>	
<b>Phone Number</b>	
<b>E-mail</b>	
<b>Purchase Date</b>	
This is to certify acceptance of the complete unit delivery with the user's manual. The warranty terms are acknowledged and accepted.	
<b>Customer's Signature</b>	

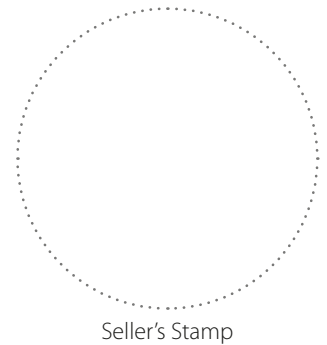

### Installation certificate

The VKMz____ unit has been connected to power mains pursuant to the requirements stated in the present user's manual.	
<b>Seller</b>	
<b>Address</b>	
<b>Phone Number</b>	
<b>Installation Technician's Full Name</b>	
<b>Installation Date:</b>	<b>Signature:</b>
The unit has been installed in accordance with the provisions of all the applicable local and national construction, electrical and technical codes and standards. The unit operates normally as intended by the manufacturer.	
<b>Signature:</b>	

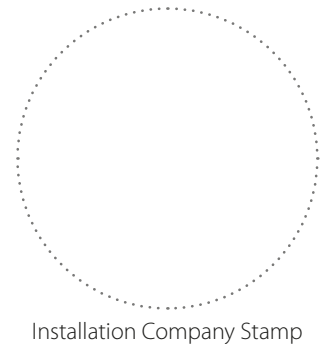

### Warranty card

<b>Unit Type</b>	Centrifugal inline fan
<b>Model</b>	VKMz____
<b>Serial Number</b>	
<b>Manufacture Date</b>	
<b>Purchase Date</b>	
<b>Warranty Period</b>	
<b>Seller</b>	

