

CF

 *VENTS*



User's manual

 *VENTS*

2011

CONTENT

Purpose	p. 3
Delivery set	p. 3
Basic technical data	p. 3
Fan designation key	p. 4
Safety requirements	p. 5
Fan structure	p. 7
Mounting and preparation to operation	p. 8
Mounting options	p. 8
Mounting sequence	p. 10
Fan electrical connection	p. 12
Wiring diagrams	p. 14
Servicing and maintenance	p. 23
Storage rules	p. 23
Manufacturer's warranty	p. 25
Acceptance certificate	p. 27
Warranty card	p. 27

The centrifugal fan VENTS CF, further referred as the fan, is designed for exhaust ventilation of living spaces, offices, shops, kitchens, WCs and other residential and public premises heated during winter time.

The fan is suitable for ceiling or wall mounting.

The operating medium must not contain any dust or other solid particles, sticky substances and fibrous materials concentrated above 100 mg/m^3 .

The delivery set comprises:

- fan - 1 pce;
- decorative front panel - 1 pce;
- dowels and screws - 4 sets;*
- user's manual - 1 pce;
- packing box - 1 pce;

The delivery set for the CF 100 turbo comprises 3 sets.

The fan is designed for connecting to single-phase AC power supply network with voltage 220-240 V and 50 Hz frequency or 12 V voltage and 50 Hz frequency for low-voltage 12 V modifications.

The fan is designed for operation in the temperature range between 0°C and $+45^{\circ}\text{C}$.

The fan does not cause interference with radio-, TV- or video- equipment.

The minimum service life is 5 years.

PURPOSE

DELIVERY SET

BASIC TECHNICAL DATA

**FAN
DESIGNATION
KEY**

CXXX 100 X X

Fan and filter type

- C - centrifugal
- F - synthetic filter
- FA - aluminium filter

Number of speeds

- _ - the fan has one speed by default
- 3 - three-speed fan

100 - exhaust pipe diameter [mm]

V - electrical switch modification

- T - timer modification
- TH - timer and humidity sensor modification
- TP - timer and motion sensor modification

Motor modifications

- turbo - high-powered motor
- 12 - low-voltage motor 12V/50 Hz

Designation key example:

VENTS CF 100 VTH turbo - CF series fan, includes a synthetic filter, flange diameter 100 mm, equipped with an electric switch, timer, humidity sensor and single-phase high-powered motor.

**SAFETY
REQUIREMENTS**

Protection rating against access to dangerous parts and water penetration:

- IP 24 for fans with a synthetic filter;
- IP 34 for fans with aluminium filter.

Disconnect the fan from power mains prior to all connection, adjustment, servicing and repair works.

Only the qualified electricians authorized for independent electrical works at electrical installations with the voltage up to 1000 V are allowed for servicing and maintenance of the fan after reading this manual.

Single-phase power network used for connection of the device must be in compliance with the acting norms and standards. The fixed wiring system must be equipped with an automatic circuit breaker.

The fan shall be connected through the switch integrated into fixed wiring system. Keep the clearance between the dead contacts not less than 3 mm for all poles.

Before installation works make sure that the fan impeller, casing and grille are free of any visible damages and that the casing has no foreign objects inside that can damage the impeller blades.

Misuse of the device, any unauthorized alteration or modification is prohibited. The device is not designed to be used by children, physically or mentally disabled persons, persons with sensory disorder, persons with no appropriate life experience and/or expertise unless they are properly instructed about the device use or supervised by the person in charge for their safety.

Keep the device out of reach of children or supervise the children to avoid their playing with the device.

Take precautions to prevent penetration of smoke, carbon monoxide and other flame products into the room through open chimney flues or other fire-protection devices.

Take also measures to disable gas back draft in case of using gas or open flame devices. The operating medium must not contain any dust or other solid particles, sticky substances and fibrous materials.

The fan operation in the environment containing flammable substances or vapours such as spirit, gasoline, insecticides etc. is not allowed.

Do not close or block unit inlet and outlet vents to ensure the most effective air passage. Do not sit or put objects on the unit.

The owner of the goods should follow the requirements set forth herein.

**WARNING**

Don't use the fan for operation in explosive dust-air mixture environment.

**PROHIBITED:**

Do not operate the fan beyond the specified operating temperature conditions as well as in environments containing aggressive mixtures.

**WARNING**

Disconnect the fan from power mains prior to all installation, connection, adjustment and repair works.

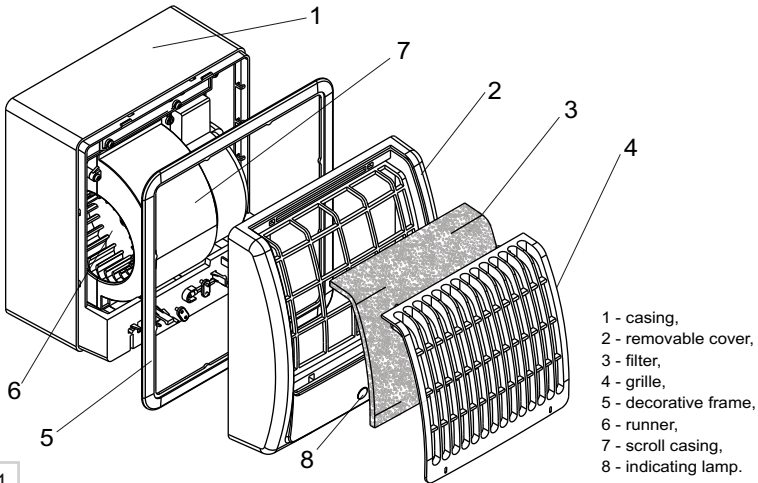
**FAN
STRUCTURE**

The VENTS CF fan (fig. 1) consists of the casing 1 with the motor and impeller 6 assembled inside of the casing. The impeller 6 is located in the scroll casing 7.

The frame 5 is locked inside the casing 1 and functions as a stopper in case of Through-the wall mounting.

The swivel cover 2 with the fixed grille 4 is attached to the casing.

The filter 3 is inserted into a space between the cover and the grille.

The back valve is installed on the fan back side in the exhaust pipe.

The LED lamp 8 indicates the fan ON/OFF operation.

**MOUNTING AND
PREPARATION
TO OPERATION**

The VENTS CF fans are suitable for wall and ceiling mounting.

The mounting options are shown in fig. 2-7.

In case of wall mounting (fig. 2) the fan is fastened to the wall with self-tapping screws included into delivery set. In case of mounting as shown in fig. 3 the fan is mounted by means of the fastening brackets.*

Bend the fastening brackets for the required length to suit mounting requirements.

The mounting option in fig. 4 provides the fan installation on the construction foam.

The mounting option in fig. 5 provides the fan installation of the fan in a specially designed recess. The fan is mounted to ceiling either with fastening brackets (fig.6) or inserted into a specially designed recess (fig.7).

The wall mounting sequence is shown in fig. 8-10.

The built-in wall mounting sequence is shown in fig. 11 and the ceiling built-in mounting sequence is shown in fig. 12.

* The basic delivery set does not include fastening brackets.

**MOUNTING
OPTIONS**

Wall mounting

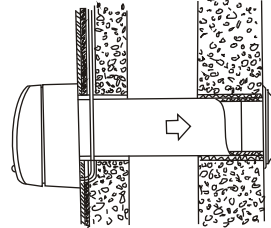
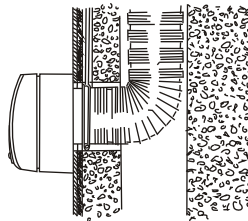

2

Flush wall mounting with fastening brackets

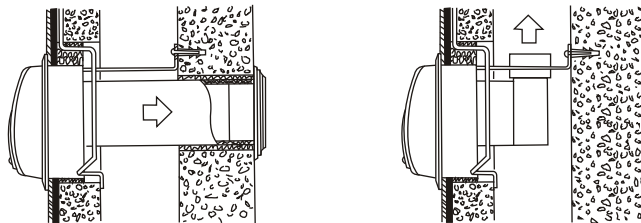

3

Flush wall mounting with construction foam

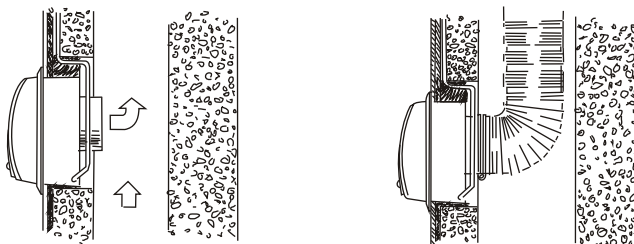

4

Built-in recess mounting

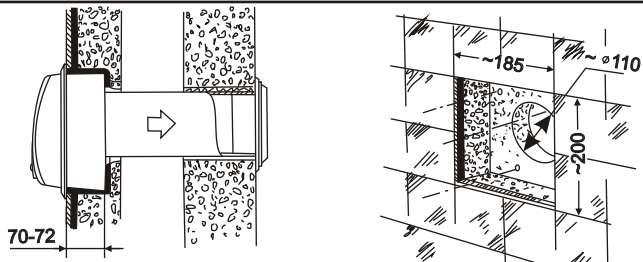

5

Ceiling mounting with fastening brackets

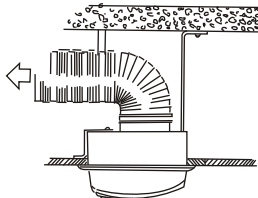

6

Ceiling mounting inside a specially designed recess

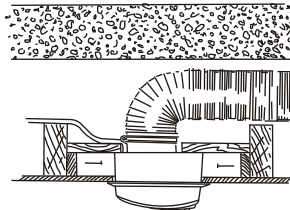

7

MOUNTING SEQUENCE

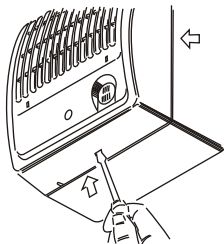

8

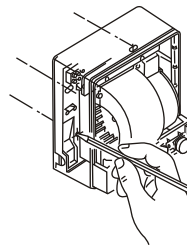

9

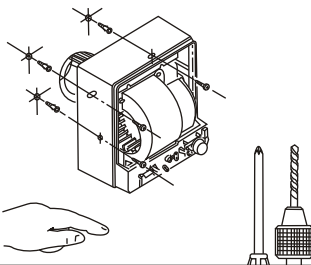

10

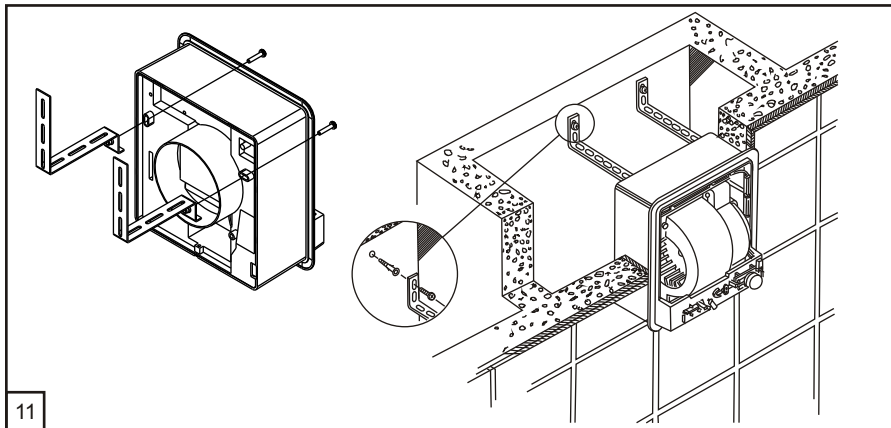

11

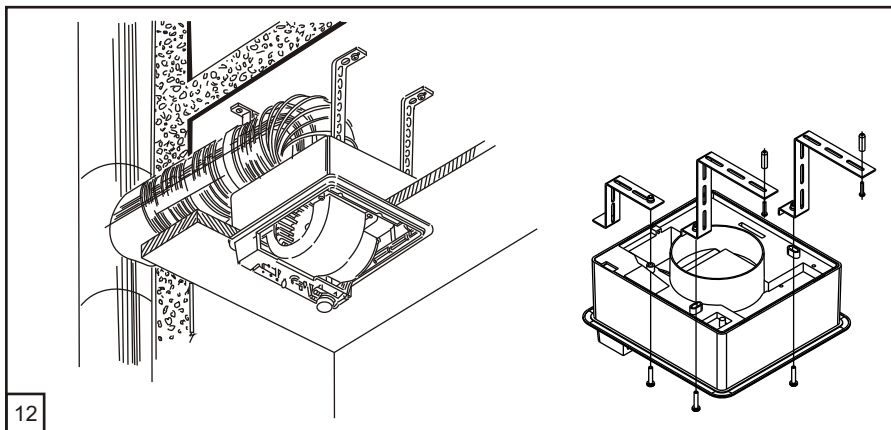

12

**FAN
ELECTRICAL
CONNECTION**

The fan shall be connected through the switch with the gap between the dead contacts not less than 3 mm for all poles.

Mounting and connection examples of the fan are shown in fig. 13-31 and diagrams 1-6.

The connection of the fan to the power supply network is as follows:

- route the supply cables through an opening in the casing bottom or make a special hole in the casing cover in case of the lateral cable connection (fig. 14);
- strip the cable ends for 7-8 mm and insert those into respective terminals to the stop and fasten with screws (fig. 15);
- fix the cables with a retaining clip (fig. 14);
- cover the fan (fig.16);
- connect the fan to the power supply network (fig. 17).

The connection of the three-speed fan to the power network is as follows:

- lead out the supply cables through an opening in the casing bottom or cut a special hole in the casing cover in case of cable connection on side (fig. 14);
- screw out the cover of the electrical part of the fan (fig. 22);
- strip the cable ends for 7-8 mm and insert those into respective terminals to the stop and fasten with screws (fig. 23);
- fix the cables with a retaining clip as shown in fig. 14;
- cover the fan (fig.24);
- connect the fan to the power supply network (fig. 25).

**WARNING**

All mounting and connection works are allowed with the fan disconnected from power supply network only.

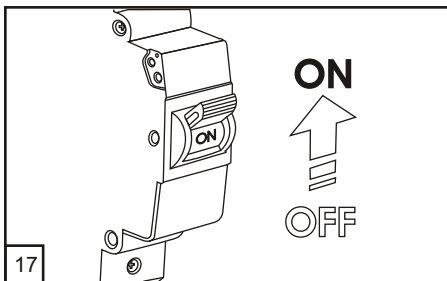
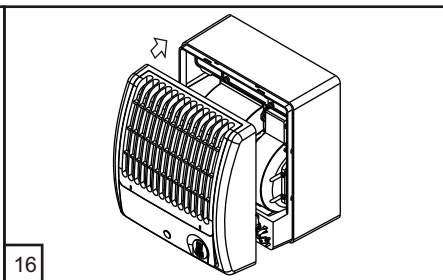
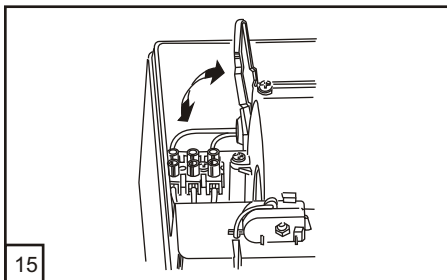
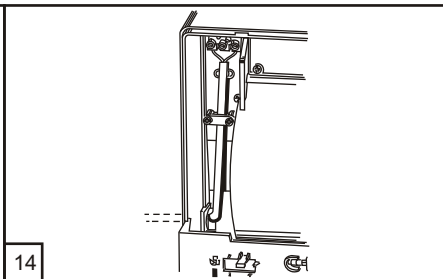
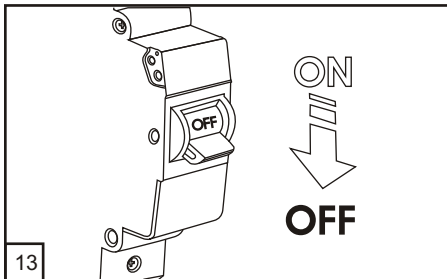

**WIRING
DIAGRAMS**

Wiring diagram of the fan for connection to the external socket

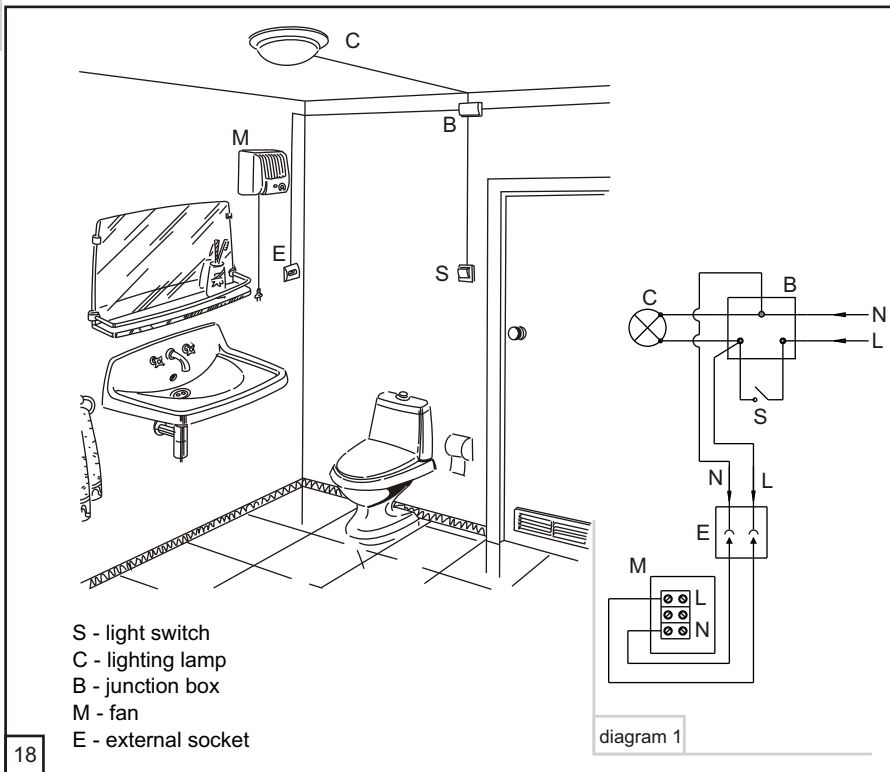

Wiring diagram of the fan with built-in switch

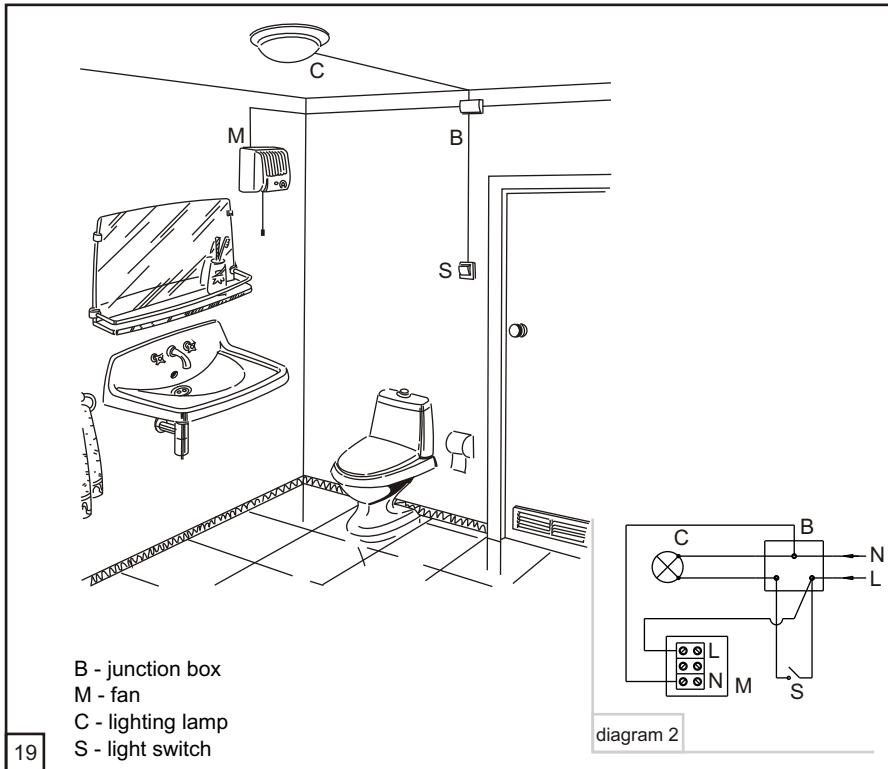

Wiring diagram of the fan without built-in switch through the external switch

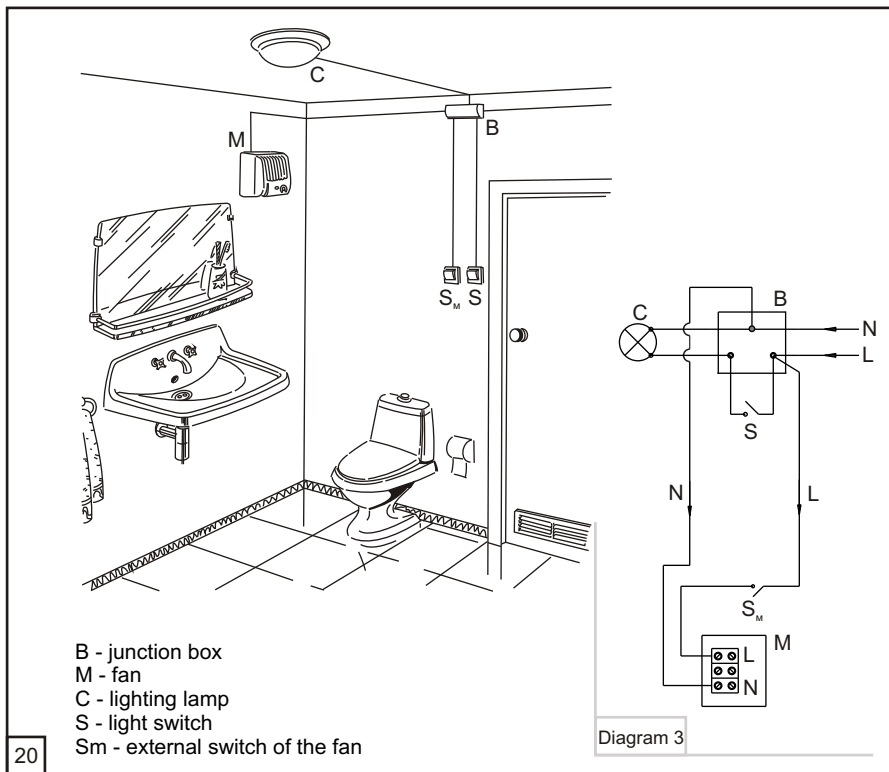

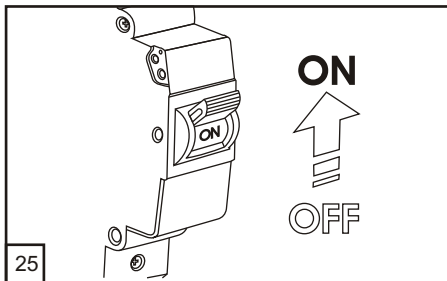
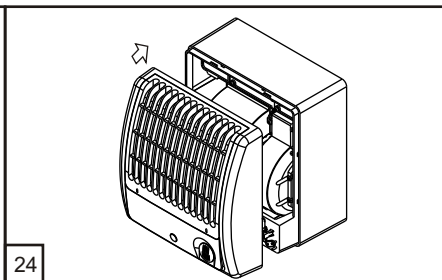
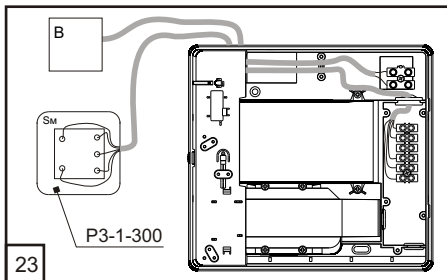
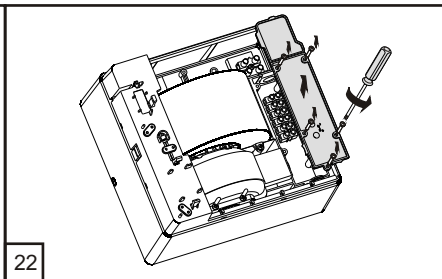
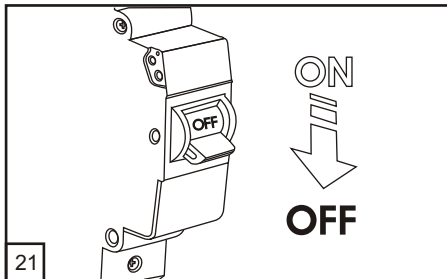

Wiring diagram of the three-speed fan with external speed switch P3-1-300.

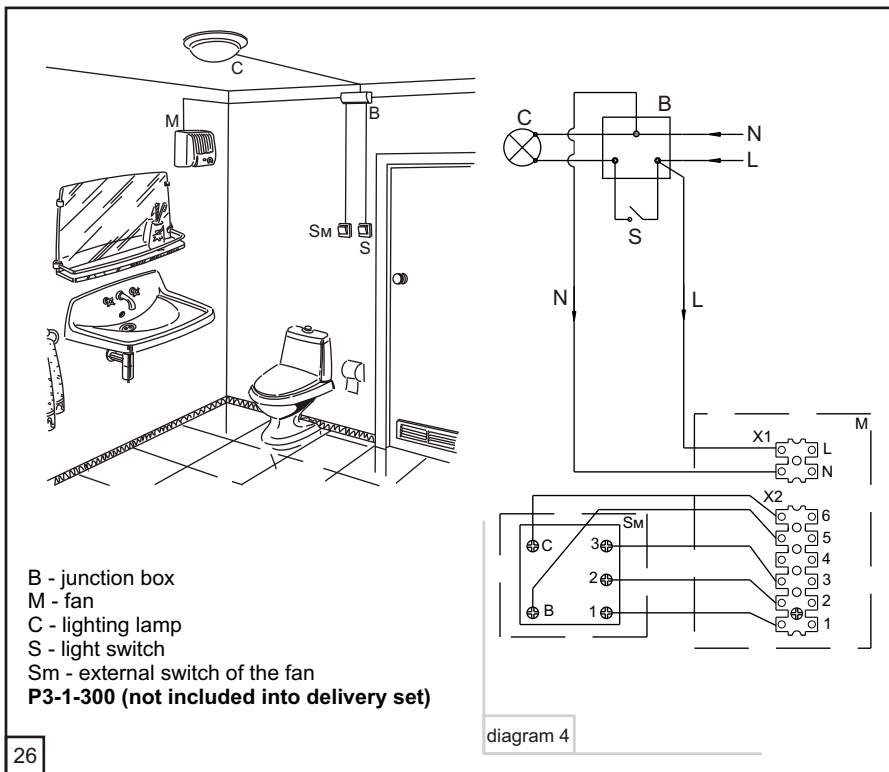

The fans with timer modification have the function of automatic shutoff after a time period between 2 and 30 minutes that is adjusted by rotating the potentiometer T clockwise to increase the turn-off time and counter-clockwise to decrease it respectively. (fig. 27).

The fans with timer and humidity sensor modification have the function of automatic turning-on as the humidity level in the ventilated area reaches the set value adjusted by rotating the potentiometer between 50 and 90% clockwise to increase the set value and counter-clockwise to decrease it within the time period set by the timer (fig. 28).

The timer circuit is under mains voltage. Any adjustments are allowed with the fan disconnected from power supply network only.

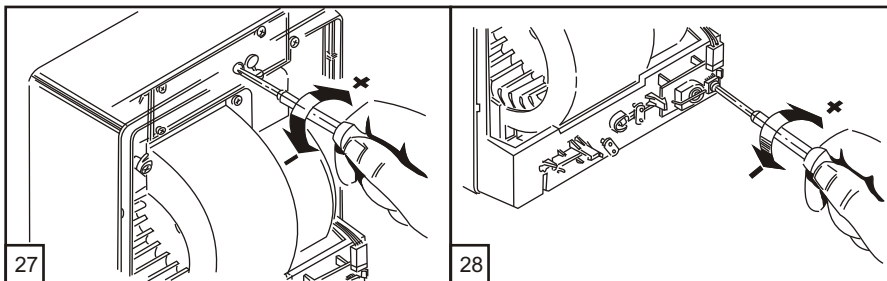
**WARNING**

Wiring diagram of the fan with timer/ timer and humidity sensor modification connected in parallel with the lighting lamp and controlled from a common switch. After the light in the room is turned off the fan continues operation within the time period set by the timer.

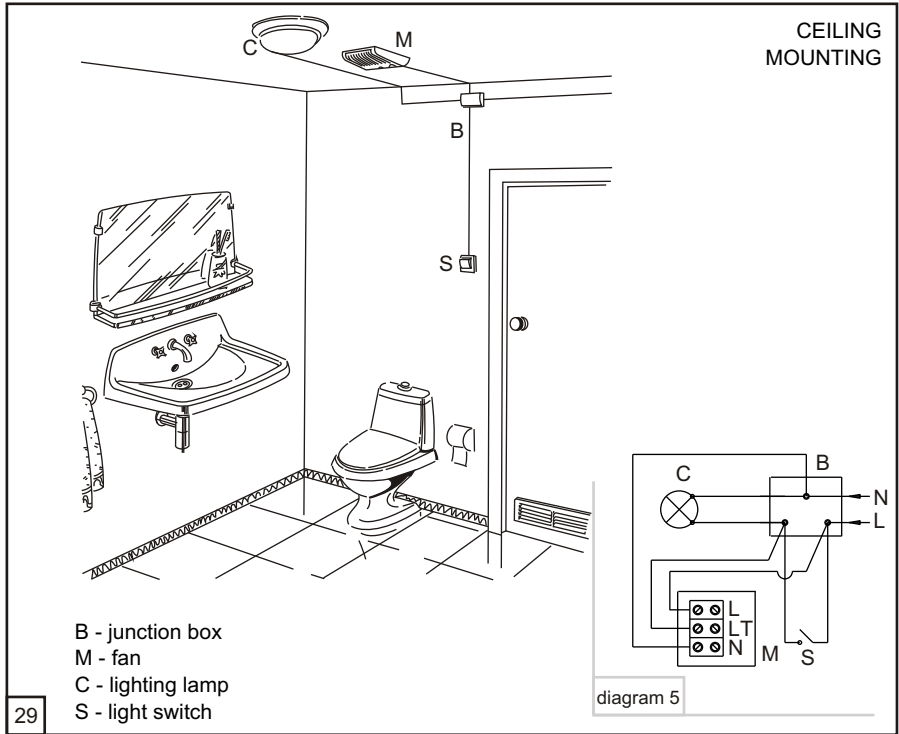

The fans with timer and motion sensor modification have the function of the automatic turning-on in case of motion detection at the distance from 1m to 4m and the horizontal viewing angle range 100° as well as automatic turning off within the time period set by the timer from 2 to 30 minutes and adjusted by rotating the rotating the potentiometer T clockwise to increase the turn-off time and counter-clockwise to decrease it respectively. (fig. 30).

The timer circuit is under mains voltage. Any adjustments are allowed with the fan disconnected from power supply network only.

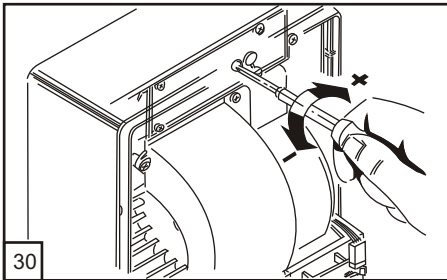
**WARNING**

Wiring diagram of the fan equipped with timer and motion sensor

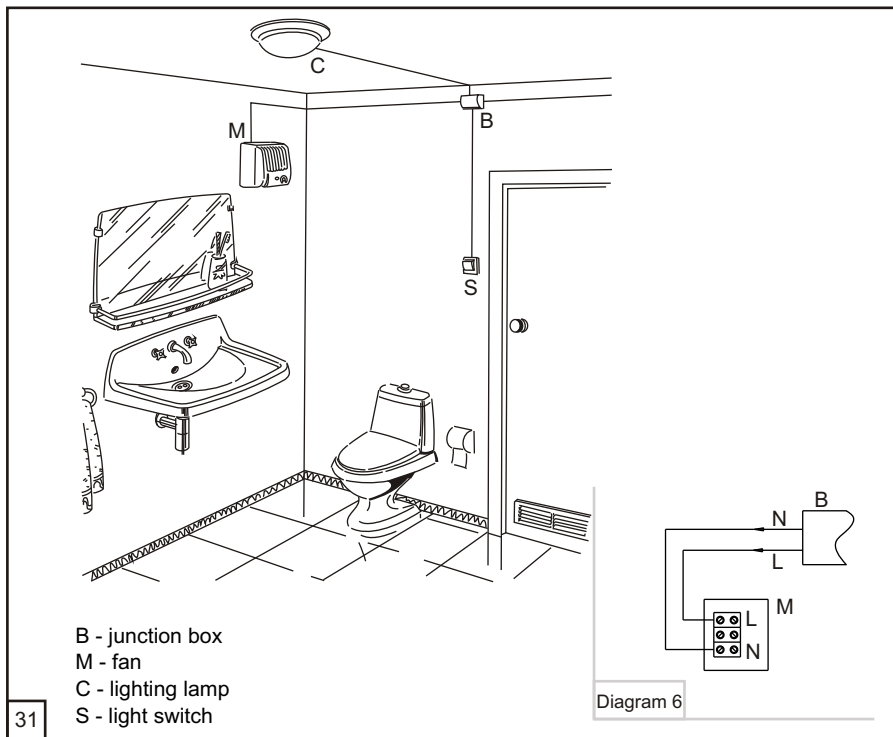

Maintenance works are allowed after the fan is disconnected from power supply network only.

Maintenance means regular cleaning of the fan surfaces from dust and dirt.

The synthetic filter should be replaced when clogged but at least once in 6 months.

To clean the aluminium filter:

- remove the cover with the filter (fig. 33);
- remove the filter (fig.34), wash it with warm water and detergent solution (fig. 35) and dry it out;
- install the filter inside the cover and snap the grille (fig. 36);
- cover the fan.

Store the fan in the original packaging in a ventilated premise at the temperature from +5°C to + 40°C and relative humidity not exceeding 60% (at +20°C).

Vapours of acid, alkaline and other aggressive admixtures in the operating medium
Are not allowed.

SERVICING AND MAINTENANCE

STORAGE RULES



*Recycle the device at the end of
service life.*

*Do not dispose the fan with other
unsorted municipal trash.*

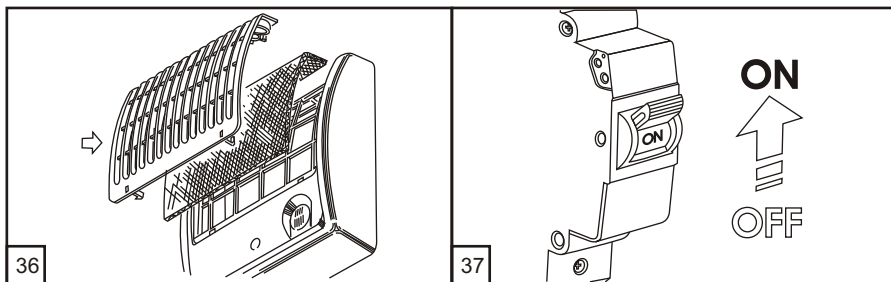
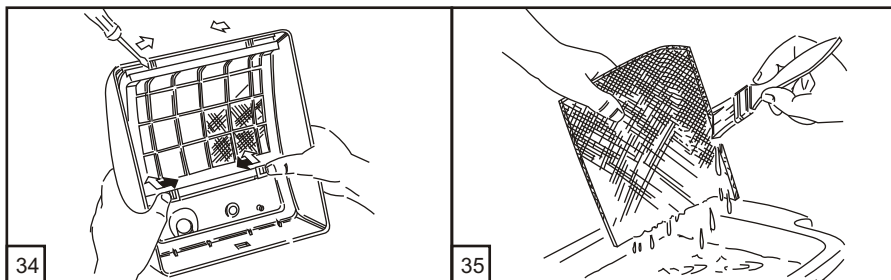
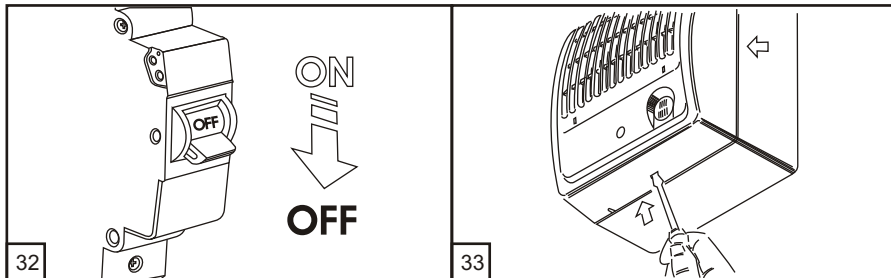

While purchasing the unit the Customer accepts the following warranty terms:

Manufacturer hereby guarantees steady performance of the fan within 60 months since the date of its sale in accordance to the rules of transportation, storage, assembling and operation.

The warranty is valid only with this user's manual, filled in manufacturing date and invoice. The fan model shall be of the same type as stated in the user's manual. In case of no confirmation of sales date the warranty period is calculated from the production date. Failure to submit the user's manual with filled manufacture and sales date may result in refuse for free servicing of faulty equipment.

All the units and components belonging to the faulty goods and replaced within the warranty period shall be covered by the previous warranty period and general warranty conditions. Thus the warranty period is neither extended nor renewed for the replaced components or the unit.

In case of any failures due to faulty manufacturing during warranty period, the Customer has the right to have the goods replaced at the manufacturing facility.

The accessories operated together with the unit, both included and not included into the delivery list as well as other equipment operating jointly with the unit shall not be covered by the warranty. The company is not responsible for compatibility of their goods with other producers' goods.

The warranty covers only the manufacturing defects. All the defects and faults resulting from mechanical effect during operation process or natural wear-and-tear shall not be covered by the warranty conditions.

The faults caused by violence of operation, servicing and maintenance guidelines either by Customer or third parties or caused by unauthorized design modifications shall not be covered by warranty.

MANUFACTURER'S WARRANTY

NO LIABILITY FOR THE RELATED DAMAGES:

The manufacturer is not responsible for any mechanical or physical damages resulting from the manual requirements violence, the unit misuse or gross mechanical effect.

The indirect damages such as re-installation or re-connection of the unit, direct or indirect losses etc. related to the unit replacement shall not be indemnified.
Mounting/dismantling, connection/disconnection and regulation of the unit shall not be covered by the warranty.

The contractor in charge for quality of mounting, electric mounting and adjustment works shall be responsible for the warranty thereof.

In any case the indemnity amount shall not exceed the actually paid value for the defective unit price.

CF 3 100 T
CFA TH Turbo
TP 12

The fan is recognized as serviceable.

Stamp of the acceptance inspector

Manufacturing date

Sold by
(name of the vendor, stamp of the shop)

Date of sale

ACCEPTANCE
CERTIFICATE

WARRANTY
CARD

