

ENERGY SAVING INLINE UNITS

ventilation systems
www.ventilation-system.com

X-VENT ENERGY SAVING
INLINE UNITS

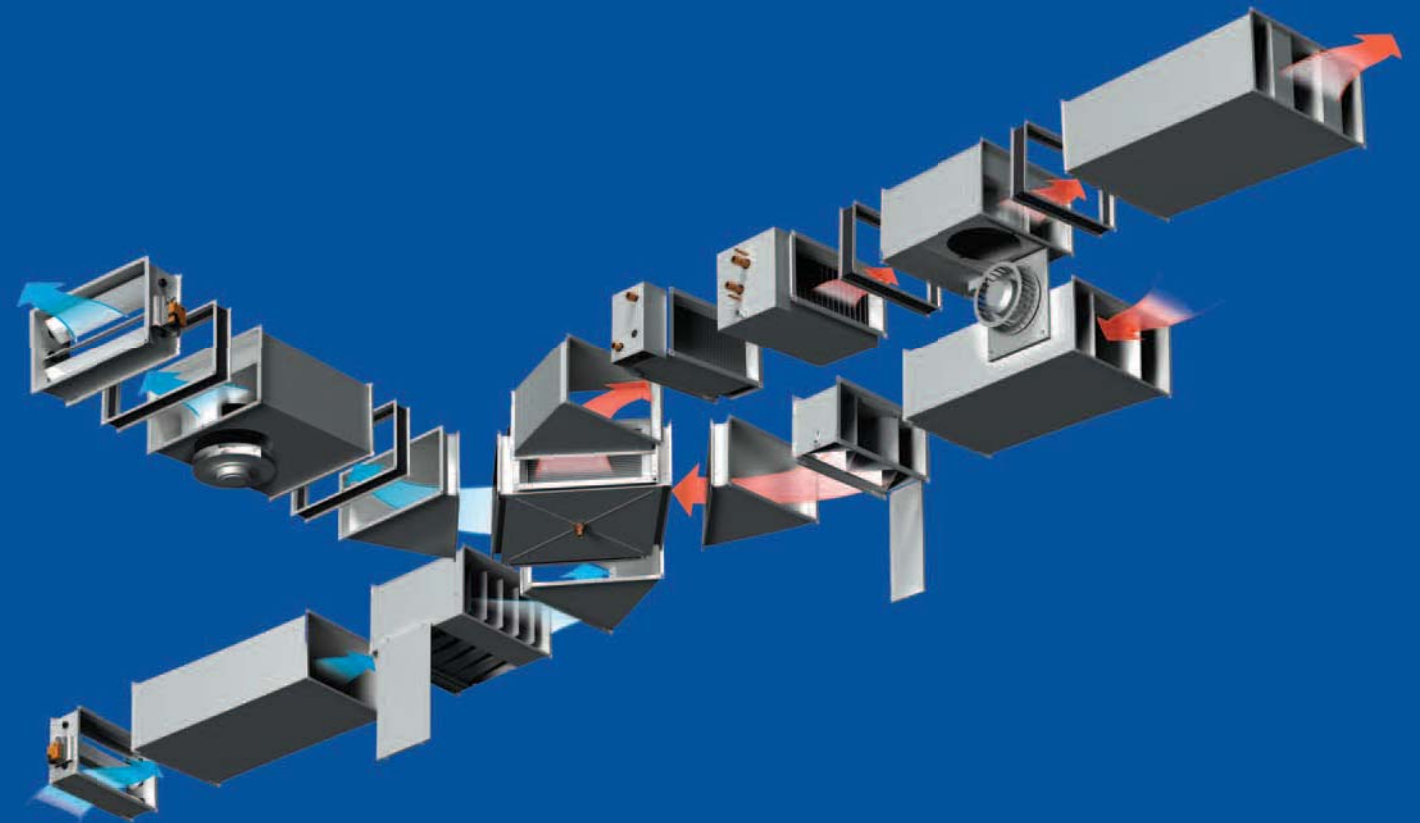
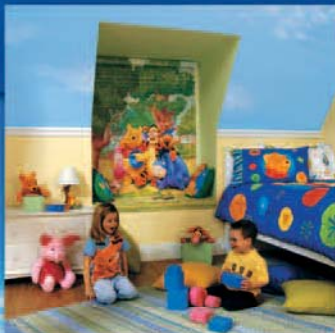

VENTS reserves the rights to modify any of its products' features, designs, components and specifications at any time and without notice to maintain the development and quality of manufactured goods.

05/2015



2015

*Fresh air in
your house!*

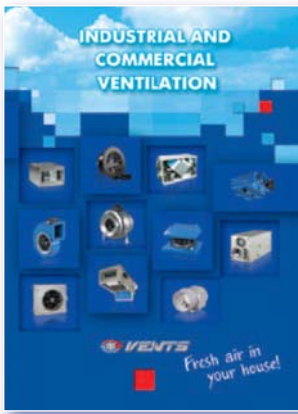

Industrial and commercial ventilation
(Catalogue no. 1)

Industrial and commercial ventilation components - fans for round and rectangular ducts, sound-insulated, axial and roof fans, air handling units with heat recovery, air heating units, accessories.

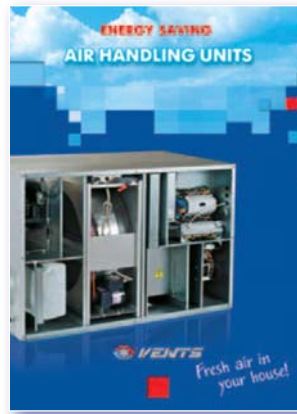

Energy saving ventilation
Air handling units
(Catalogue no. 2)

Energy saving supply and exhaust units and air handling units with heat recovery with air capacity up to 6500 m³/h.

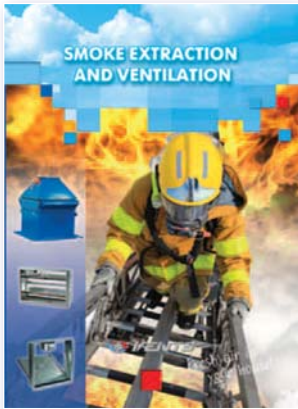

Smoke extraction and ventilation
(Catalogue no. 5)

Smoke protection systems of buildings and premises.

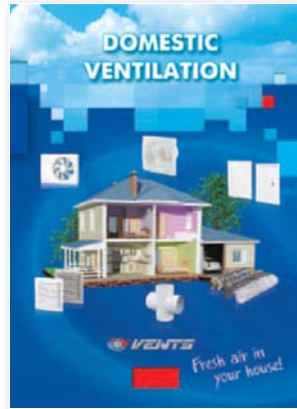

Domestic ventilation
(Catalogue no. 6)

Domestic ventilation: fans, mono-pipe exhaust kitchen and bathroom fans, air distribution units, air ducts and fittings, access doors, ventilation kits.

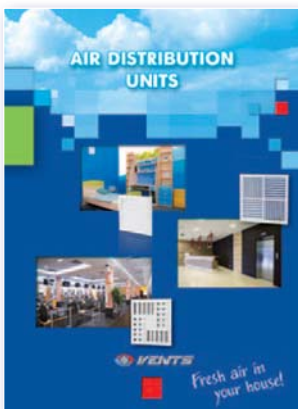

Air distribution units
(Catalogue no. 9)

Plastic and metal air distribution products (grilles, disk valves, diffusers, etc.) for ventilation, air conditioning and heating.

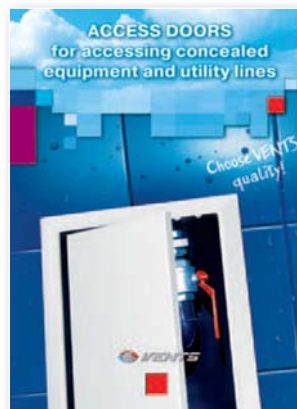

Access doors
(Catalogue no. 10)

Plastic and metal access doors for accessing concealed equipment and utility lines. Special offers for ceramic tiles.

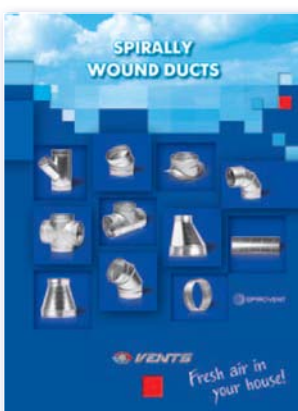

Spirally wound ducts
(Catalogue no. 13)

SPIROVENT spiral seam vent ducts and fittings of 100 to 1600 mm diameter.



Flexible ducts and fittings for ventilation, air conditioning and heating
(Catalogue no. 14)

Flexible and semi-flexible air ducts made of polymeric materials, aluminium, galvanized or stainless steel, metal fittings for ventilation, air conditioning, heating, gas handling and abrasive particles aspiration.



**Air handling units
AirVENTS
(Catalogue no. 3)**

Energy saving air handling units with air capacity up to 40 000 m³/h, for use in large residential, industrial and commercial objects.

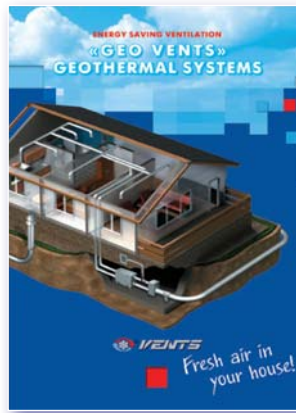

**Energy saving ventilation
Geothermal systems
GEO VENTS
(Catalogue no. 4)**

Energy saving system GEO VENTS with use of the earth's surface layers heat. High ventilation system energy efficiency and low operating costs.



**Domestic fans
(Catalogue no. 7)**

Domestic fans with air capacity up to 365 m³/h with extra functions: timer, humidity sensor, motion sensor, etc. Applied for premises up to 30 m².

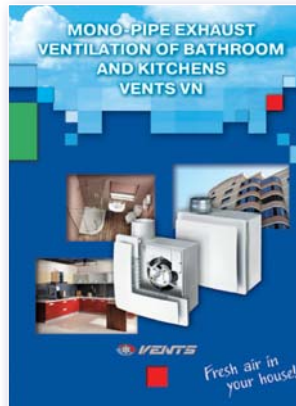

**VENTS VN
Mono-pipe exhaust ventilation
(Catalogue no. 8)**

Exhaust ventilation in houses with mono-pipe ventilation system based on VENTS VN fans.



**Energy saving ventilation.
Single room energy recovery ventilators MICRA.
(Catalogue no. 11)**

MICRA single room ventilators with energy regeneration for efficient ventilation and lowest investments in ready-built and brand new premises.

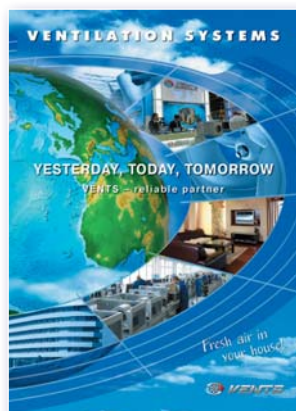

**VENTS presentation catalogue
(Catalogue no. 12)**

VENTS mission is to bring fresh air to your house and surround you with the world of comfortable microclimate.

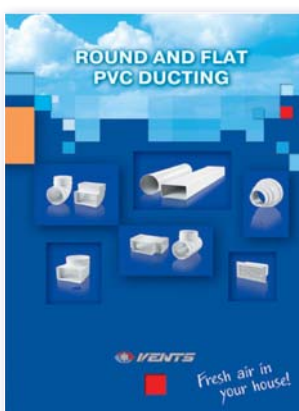

**Round and flat PVC ducting
(Catalogue no. 15)**

Flat and round PVC ducts PLASTIVENT for ventilation of residential, office and commercial premises and connection of exhaust ventilation equipment (kitchen extractors, hoods, exhaust boxes, etc). Wide product range of fittings.



**Energy saving ventilation.
Single room energy recovery ventilators
TwinFresh.
(Catalogue no. 16)**

Single room reverse ventilators with energy regeneration TwinFresh for efficient ventilation and lowest investments in ready-built and brand new premises.



About us

page
4

Ventilation in our life

page
6

ENERGY-SAVING
Inline UNITS
X-VENT

page
14

RECTANGULAR INLINE FANS



VENTS VKP EC
Inline centrifugal fan
with EC motor

page
16



VENTS VKP
Inline centrifugal fan

page
20



VENTS VKP 4D 1000x500
Inline centrifugal fan

page
20



VENTS VKPI
Inline centrifugal heat-
and sound-insulated fan

page
20



VENTS VKPI EC
Inline centrifugal fan
with EC motor

page
26



VENTS VKPF
Inline centrifugal fan

page
30



VENTS VKPFI
Inline centrifugal heat-
and sound-insulated fan

page
30

ACCESSORIES



NK
Duct electric heater

page
42



NK...U
Duct electric heater with
a control unit

page
42



NKV
Duct water heaters

page
48



USWK
The mixing unit

page
60

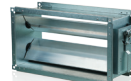

RRV
Air flow controllers

page
62



SKRA
Mixing chambers

page
63



OKW
Duct water coil air coolers

page
64



OKW1
Duct water coil air coolers

page
64



OKF
Direct-expansion
duct coolers

page
72



OKF1
Direct-expansion
duct coolers

page
72

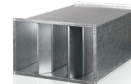

SR
Plate silencer

page
80

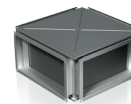

PR
Plate heat exchanger with
X-shaped air passage

page
82



FBK
Bag type air filter

page
84



FB
Panel type air filter

page
86



VVG
Flexible connectors

page
87

ELECTRICAL ACCESSORIES



RSA5E-2-P
Single phase
speed controller

page
88



RSA5E-...-M
Single phase speed controller

page
89



KDT2-MK
Duct temperature sensors with a terminal box

page
102



RSA5E-...-T
Single phase speed controller

page
90



NDT
Outdoor temperature sensor

page
103



RSA5D-...-T
Three phase speed controller

page
91



NDT2
Outdoor temperature sensor

page
104



RSA5D-...-M
Three phase speed controller

page
92



TG-K
Duct temperature sensors

page
105



RTS -1- 400
RTSD -1- 400
Temperature regulator

page
93



CO2-1
CO₂ sensor

page
106



DTV 500
Pressostat

page
94



CO2-2
CO₂ sensor

page
106



F-3000
Thermostat

page
95



BELIMO CM230/CM24
Electric actuator

page
107



RNS
TRIAC power controller for electric heaters

page
96



BELIMO LM230A/LM24
Electric actuator

page
108



PULSER-M
Electric triac temperature controller

page
98



BELIMO TF230/TF24
Electric actuator

page
109



KDT-M/KDT-M1
Temperature sensors

page
99



BELIMO LF230/LF24
Electric actuator

page
110



KDT2-M/KDT2-M1
Temperature sensors

page
100

Automation on the basis of **SL-Aqua** and **SL-Electric** control boards

page
111



KDT-MK
Duct temperature sensors with a terminal box

page
101



SL-Aqua
Control board

page
112



SL-Electric
Control board

page
120

WELCOME TO THE VENTS WORLD!



VENTS company was founded in the nineties of the XXth century.

Dynamic development of the enterprise and ongoing study of the consumer demand enabled rapid international leadership of the company in the ventilation industry.

VENTS is a powerful research and development enterprise with 2500 professionals working as a single team to ensure a full production cycle from idea to end product. The production base of the company is located at more than 60 000 m² area. It includes 16 workshops equipped under the latest international standards and each of them is comparable to a separate plant.

Modern equipment, active implementation of advanced technologies and highly automated production are the characteristic features of VENTS company.

The company undergoes rapid dynamic development; fundamental researches and effective designs in climatic equipment industry are in the focus of the company's business strategy.

The joint cooperation of the corporate design department, test laboratories and production workshops let us introduce high quality products to the market.

Special attention is paid to the manufacturing of the goods during all manufacturing stages including monitoring of the technological conditions. Technical characteristics of supplied raw materials are thoroughly checked. Quality control system which meets international standard requirements ISO 9001:2000 was implemented at the enterprise.

Environmental protection is one of the basic components of the corporate development. The technological process at the enterprise is arranged in such a way as to exclude any negative impact to the environment. To solve the global energy saving problem we develop a special climatic equipment that provides comfortable conditions for people and reduces the energy demand significantly.

Perfect quality, competitive prices, high production potential, technical capabilities and the wide product range stimulate long-term partnership and product promotion all over the world.

The VENTS ventilation products are exported to more than 90 countries and are sold through the distribution network of 120 companies worldwide. Share of the VENTS products globally is above 10%.

VENTS is a member of high-rank international organizations, the leading HVAC experts.

Since 2008 VENTS has been a fully-featured member of HARDI Association (Heating, Air-conditioning and Refrigeration Distributors International, USA).

Since 2010 VENTS has been a participant of AMCA Association (the Air Movement and Control Association (AMCA) International, Inc.). In 2011 VENTS successfully passed tests for compliance with AMCA standards and the VENTS products were certified for the USA market.

In 2011 VENTS joined HVI (Home Ventilation Institute, USA) Association.





Metal processing workshop



Spiral air ducts workshop



Flexible air ducts workshop



Aluminium grilles and diffusers workshop



Powder coating workshop



Wet coating workshop



Extrusion workshop



Injection moulding workshop



Residential fans workshop



Ventilation grilles workshop



Electric motors workshop



Industrial fans workshop



Air handling units workshop



AirVENTS air handling units workshop



Electrical accessories workshop



Extruded grilles workshop

Powerful production facilities, high automation level, active implementation of innovative technologies in the production process made VENTS a worldwide ventilation leader.

We manufacture our products with respect to unique geographical, climatic, technical features of each country and do our best to fulfill the client's wishes anywhere anytime.



Get benefit from cooperation with VENTS TM and enjoy the maximum range of products of the top quality from one manufacturer.

VENTILATION IN OUR LIFE



▶ What Is Ventilation?

Ventilation is a set of actions and techniques used to arrange air exchange and to provide a specific air medium condition in the premises and in working places. Ventilation maintains desirable indoor climatic parameters in compliance with set hygienic norms and technology requirements.

▶ What Is Ventilation Required For?

We are surrounded with air and breathe in and out 20 000 litres of air every day. How much healthy is the air we breath in? There is a range of aspects to determine air quality.

- ▶ **Oxygen and carbon dioxide concentration in the air.** Oxygen decrease and carbon dioxide cause stuffiness in the premises.
- ▶ **Content of harmful substances and dust in the air.** High content of dust, tobacco smoke and other substances in the air are harmful for the human organism and can cause various lung and skin diseases.
- ▶ **Odours.** Bad smell causes discomfort and irritates.
- ▶ **Air humidity.** Too high or low humidity makes us feel uncomfortable and even may provoke acute disease attacks for sick people. Air humidity is important also for inner climate. For instance, doors, window frames, furniture may shrink because of too low humidity in winter and get swollen in humid environments, e.g. in swimming-pools, bathrooms.
- ▶ **Air temperature.** The comfortable indoor temperature is within 21-23 °C. Higher or lower temperatures influence physical and mental activity and health condition.
- ▶ **Air motion.** Increased air motion in the premises causes drafts and low air motion causes air blanketing. Any of these factors influence our well-being.

▶ Ventilation system arrangement

Properly arranged ventilation system is the only solution in this situation. It provides supply of filtered air in summer and supply of filtered and warmed up air in winter as well as extract stale air removal from the premises.

Any ventilation system must include synchronous fresh air supply and extract air exhaust thus ensuring the ideal air balance in the room. In case of poor or insufficient air intake from outside the oxygen content decreases, humidity and dustiness level increase. If exhaust ventilation is not provided or it is not efficient, polluted air, smells, humidity and harmful substances are not removed.

One more important factor for properly arranged ventilation system is joint operation of supply and exhaust air vents. If indoor ventilation is provided by air exhaust only, e.g. by an extract bathroom fan, the only possible air supply source is the gaps in windows, doors and construction elements. This uncontrollable air supply results in dust ingress, smells and draughts.

Ventilation grilles in the bathroom doors, wall or window vents, open windows are the only natural supply air sources that may compensate for air extraction. However mechanical ventilation is the only solution to provide central air supply in the rooms.

▶ Calculation of the required air exchange.

Ventilation design recommendations

Calculation of air exchange according to air exchange rate:

Ventilation air volume is determined for each premise separately considering concentration of harmful substances. Alternatively, ventilation air volume calculated be set according to the research results. If the nature and concentration of harmful substances is not possible to determine, air exchanged is calculated as following:

$$L = V_{\text{prem.}} \cdot \text{Ach} \quad [\text{m}^3/\text{h}],$$

where **V_{prem.}** – premise volume [m³];

Ach – minimum air exchange per hour, refer air exchange table.

How to determine a premise volume?

Use a simple formula:

length x width x height = volume of the premises in cubic meters

$$A \times B \times H = V \text{ [m}^3\text{]}$$

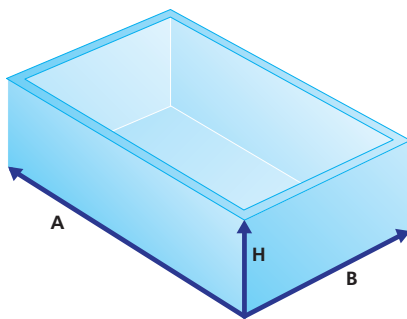

Example: a premise with 7 m length, 4 m width and 2.8 m height. To determine the air volume required for ventilation of this premises, calculate the room volume $7 \times 4 \times 2.8 = 78.4 \text{ m}^3$. After that determine the required efficiency of the fan using the following tables of recommended ventilation rate.

Calculation of air exchange according to number of inhabitants:

$$L = L_1 * N_L \text{ [m}^3\text{/hour]},$$

where L_1 – rated value for air volume per one person, $\text{m}^3/\text{h} \cdot \text{person}$;

N_L – number of inhabitants in the premises

20-25 m^3/h per one person at low physical activity

45 m^3/h per one person at light physical activity

60 m^3/h per one person at heavy physical activity

Calculation of air exchange with vapor emission:

$$L = \frac{D}{(d_v - d_n) * \rho} \text{ [m}^3\text{/hour]}$$

where D – moisture, g/hour;

d_v – moisture content in the exhaust air, gram of water/kg of air;

d_n – moisture content in the intake air, gram of water/kg of air;

ρ – air density, kg/m^3 (at $20^\circ\text{C} = 1.205 \text{ kg}/\text{m}^3$);

Calculation of air exchange to remove excessive heat:

$$L = \frac{Q}{\rho * C_p * (t_v - t_n)} \text{ [m}^3\text{/hour]}$$

Q – heat emission in the premises, kW;

t_v – exhaust air temperature, $^\circ\text{C}$;

t_n – intake air temperature, $^\circ\text{C}$;

ρ – air density [kg/m^3] at $20^\circ\text{C} = 1.205 \text{ kg}/\text{m}^3$;

C_p – heat capacity of air [$\text{kJ}/(\text{kg} \cdot \text{K})$] at 20°C ; $C_p = 1.005 \text{ kJ}/(\text{kg} \cdot \text{K})$

Air ventilation rate:

Premise	Air exchange rate	
Domestic premises	Living room of apartments or hostel residential premises	3 m^3/h for 1 m^2 in residential premises
	Kitchen in flat or hostel	6-8
	Bathroom	7-9
	Shower cabin	7-9
	WC	8-10
	Home laundry room	7
	Cloakroom	1.5
	Storeroom	1
	Garage	4-8
	Cellar	4-6
	Industrial premises and large premises	Theatre, cinema, conference hall
Office		5-7
Bank		2-4
Restaurant		8-10
Bar, café, pub, billiard room		9-11
Professional kitchen		10-15
Supermarket		1.5-3
Chemist's		3
Garages and vehicle repair shops		6-8
Public WC		10-12 (or 100 m^3 per each WC pan)
Dance halls and disco clubs		8-10
Smoking rooms		10
Server rooms		5-10
Sport hall		80 m^3 or more for each sportsman and 20 m^3 or more for each viewer
Hair dresser's		
Up to 5 working places		2
More than 5 working places		3
Warehouses		1-2
Laundryroom		10-13
Swimming pool		10-20
Industrial painting shop	25-40	
Machine shop	3-5	
School classroom	3-8	

Calculation of air exchange depending on maximum permissible concentration of aggressive substances in the air:

$$L = \frac{G_{\text{CO}_2}}{U_{\text{PDK}} - U_p} \text{ [m}^3\text{/hour]}$$

G_{CO_2} – CO_2 release amount [l/hour],

U_{PDK} – CO_2 maximum permissible concentration, l/m^3 ,

U_p – gas content in the intake air, l/hour .

CO₂ permissible concentration norms, l/m³

Permanent residential premises	1.0	
Hospitals and child care centers	0.7	
Periodically occupied premises	1.25	
Short stay premises	2,0	
Open air:	Populations centers (village)	0.33
	Small towns	0.4
	Big cities	0.5

▶ What is pressure loss?

Air resistance in ventilation system is mainly determined by air speed in this system. Air resistance grows directly proportional to air flow. This phenomenon is known as pressure loss. Static pressure produced by a fan causes air motion in the ventilation system with a certain resistance. The higher the ventilation resistance in the system, the less air flow of the fan is. Friction losses for air in air ducts as well as resistance of the networking equipment (a filter, silencer, heater, valves and dampers, etc.) can be calculated using the tables and diagrams contained in the catalogue. Total pressure loss is equal to all pressure loss values in a ventilation system.

Recommended air motion speed rate inside the air ducts:

Type	Air speed, m/s
Main air ducts	6,0 - 8,0
Side branches	4,0 - 5,0
Air distribution ducts	1.5 - 2,0
Supply ceiling grilles	1.0 - 3,0
Extract grilles	1.5 - 3,0

Calculation of air speed in the air ducts:

$$V = \frac{L}{3600 \cdot F} \quad (\text{m/s})$$

L – air capacity [m³/hour];
F – duct cross section [m²];

Recommendation 1.

Pressure loss in the duct system can be reduced due to larger duct section which provides relatively even air speed in the whole system. The figure below shows

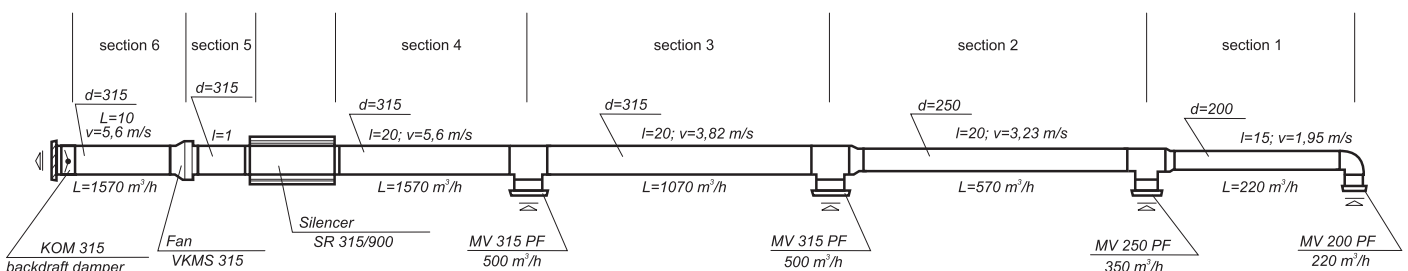

how to provide relatively even air speed in the duct system with the minimum pressure loss.

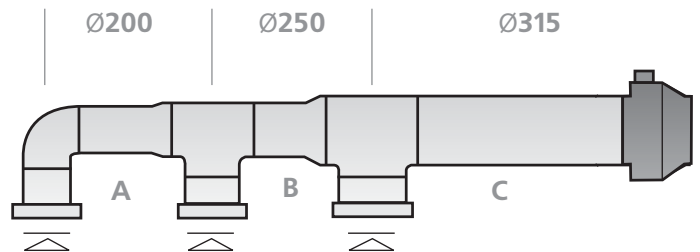

Recommendation 2.

For long systems with many ventilation grilles, install a fan in the middle of the network. Such solution has several advantages. On the one hand, pressure losses are reduced, on the other hand, smaller ducts are used.

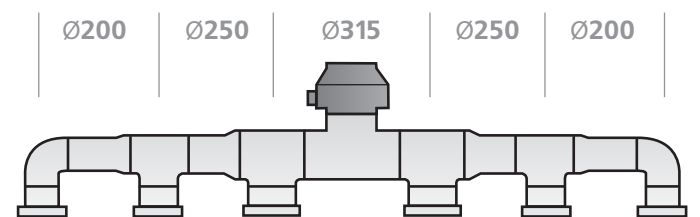

Ventilation system calculation example:

Start the calculation with the system drafting, showing the location of the air duct, ventilation grilles, fans and also the air duct section lengths between T-joint. Then calculate the air capacity at each section.

To calculate the pressure loss in the sections 1-6, use the pressure loss diagram for round air ducts. For that the required air duct diameters and pressure loss shall be determined under condition of permissible air speed in the duct.

Section 1: air flow is 200 m³/h. Suppose that the air duct diameter is 200 mm and air speed is 1.95 m/s, then the pressure loss is 0.21 Pa/m x 15 m = 3 Pa (refer to the pressure loss diagram for the air ducts).

Section 2: the same calculations shall be performed considering that the air speed through this section is 220+350=570 m³/h. Suppose that the air duct diameter is 250 mm and air speed is 3.23 m/s, then the pressure loss is 0.9 Pa/m x 20 m = 18 Pa.

Section 3: air flow through this section is 1070 m³/h. Suppose that the air duct diameter is 315 mm and air speed is 3.82 m/s, then the pressure loss is 1.1 Pa/m x 20 m = 22 Pa.

Section 4: air flow through this section is 1570 m³/h. Suppose that the air duct diameter is 315 mm and air speed is 5.6 m/s, then the pressure loss is 2.3 Pa/m x 20 m = 46 Pa.

Section 5: air flow through this section is 1570 m³/h. Suppose that the air duct diameter is 315 mm and air speed is 5.6 m/s, then the pressure loss is 2.3 Pa/m x 1 m = 23 Pa.

Section 6: air flow through this section is 1570 m³/h. Suppose that the air duct diameter is 315 mm and air speed is 5.6 m/s, then the pressure loss is 2.3 Pa/m x 10 m = 23 Pa. The total air pressure in the ductwork system is 114.3 Pa.

As the last section pressure loss calculation is over, you can start calculating pressure loss in the network elements as silencer SR 315/900 (16 Pa) and in the backdraft damper KOM 315 (22 Pa). Calculate also pressure loss in the branches to the grilles. The total air resistance in 4 branches makes 8 Pa.

Pressure loss calculation in air duct T-joints.

The diagram enables calculation of the pressure loss in the branches on the basis of bend angle, air duct diameter and air capacity.

Example. Calculate the pressure loss for 90° bend, Ø 250 mm and air flow 500 m³/h. For that find the intersection point of the vertical line that shows the air capacity with the vertical line. Find the pressure loss on the vertical line on the left for 90° pipe bend which makes 2 Pa.

Suppose we install the PF ceiling diffusers with air resistance 26 Pa.

Now let us sum up all the pressure losses for the straight air duct section, network elements, bends and grilles. The target value is 186.3 Pa.

After all calculations we come to the conclusion that we need an exhaust fan with air capacity 1570 m³/h at the air resistance 186.3 Pa. Considering all the required operating parameters the VENTS VKMS 315 fan is the best solution.

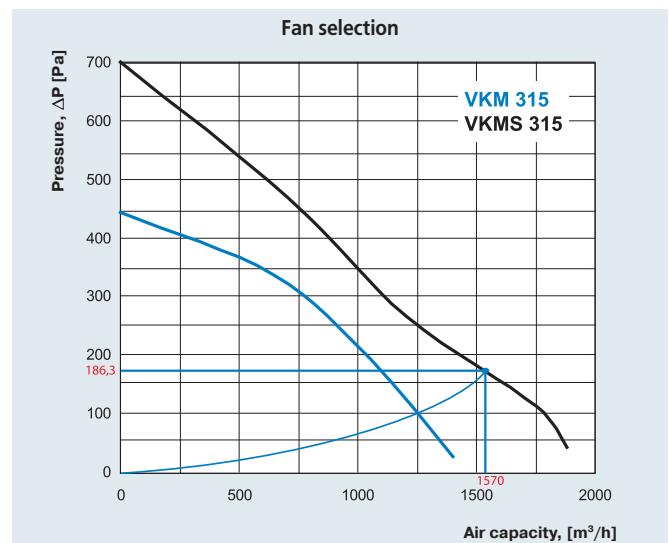
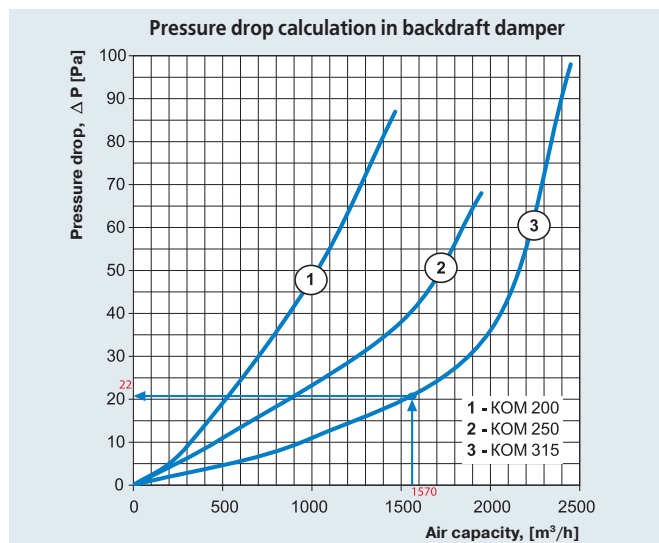
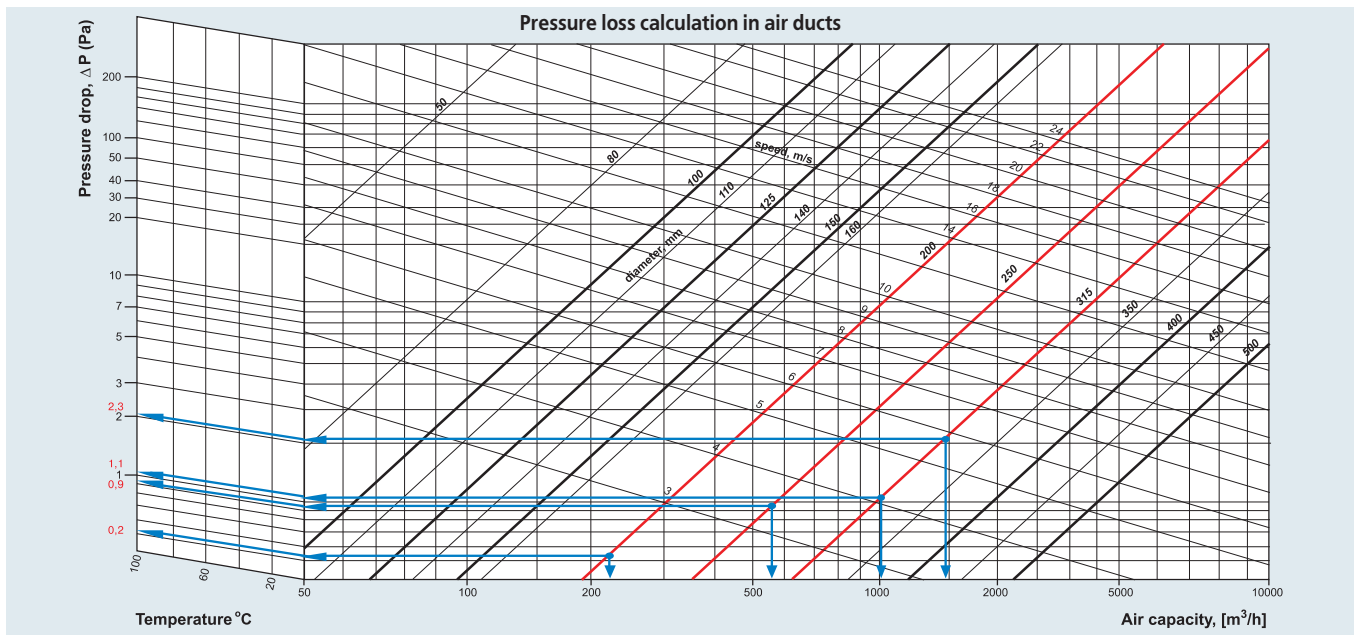



Fan types:

Fans are mechanical units designed for air transportation in the ducts, direct air supply or air exhaust from the premises. Air is moved due to the pressure drop between the fan inlet and outlet vent.

An axial fan has the form a cylindrical-cased wheel with the impeller fixed to a bushing at some angle to rotation plane. As the impeller blades rotate air is trapped between and is moved further axially. Air is hardly moved in the radial direction. The axial fan blades are mostly set directly on the motor shaft.

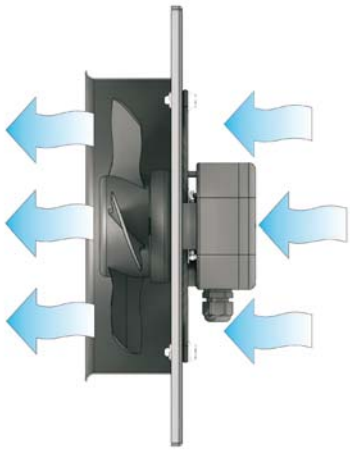

Application:
 ▶ air supply and air extract through openings or assembled to max. 3 m air ducts at low air dynamic resistance in the system.

A mixed-flow fan is able to move air along the motor shaft. Such fans are widely applied in the ventilation systems with round air ducts.

Round inline fans are available in standard sizes ranging from 100 up to 450 mm with the air capacity range from 250 to 5200 m³/h. The impellers with backward-curved blades are powered by the asynchronous external rotor motors. The ball bearings are rated for long service life. The fan casing may be made of plastic, polymer-coated or galvanized steel and has good corrosion-resistant properties and a nice look.

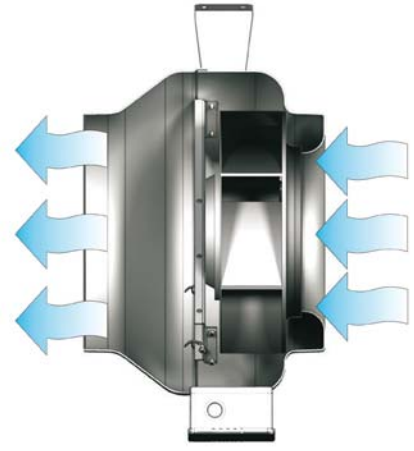

Application:
 ▶ air exhaust and supply in long ventilation systems with high air dynamic resistance.

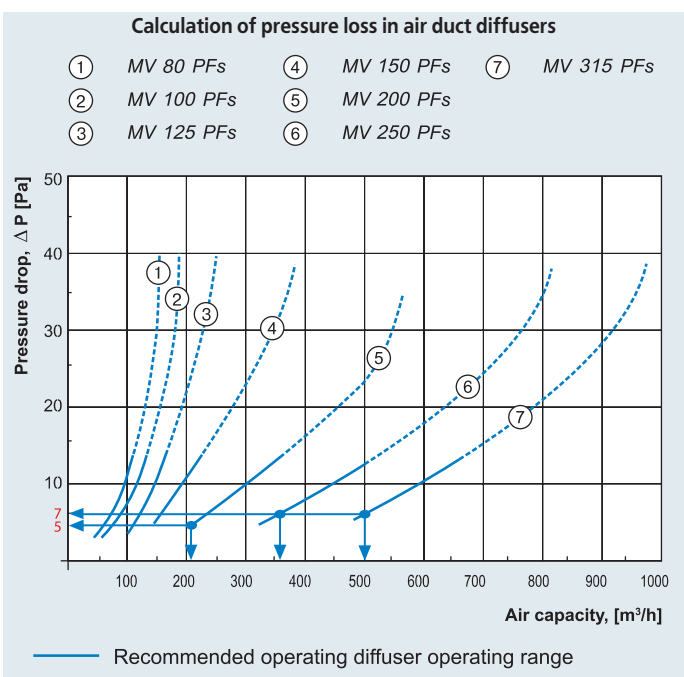
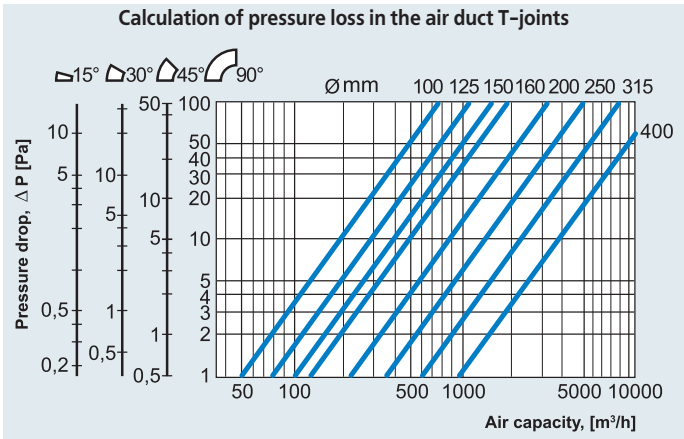
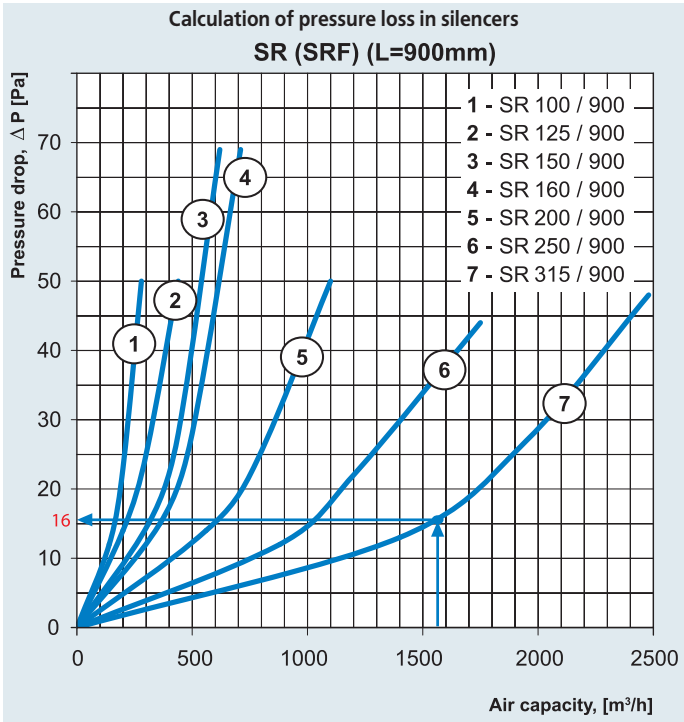

A centrifugal fan consists of an impeller and a scroll casing. An impeller is a hollow cylinder with mounted blades inside, circumferentially fixed with disk plates. The hub for mounting the impeller on the shaft is located at the center of the strengthening ring.

During the impeller operation air is trapped between the blades, gets compressed and is moved from the center. Under centrifugal force air is transported to the scroll casing and then moved to the exhaust pipe. The centrifugal fans are equipped with forward or backward curved blades. Backward curved blades enable up to 20% energy saving. Another important privilege of backward-curved blades is their high air overload capability. Centrifugal fans with forward-curved blades ensure the same air capacity and pressure characteristics as the



Backward curved blades

backward-curved blades do but they require smaller impeller diameter and lower speed. So they are able to attain the required result demanding less space and producing less noise.

Application:

- ▶ air exhaust and supply in ventilation systems with long air ductworks and high air dynamic resistance.

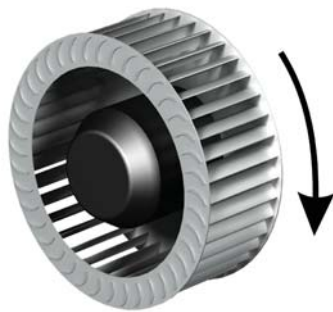

Forward curved blades

▶ Fan speed control

Fan speed is controlled with thyristor or transformer speed controllers.

Thyristor speed control.

Thyristor speed controllers provide smooth manual motor speed control and air flow control respectively. Operation of the thyristor speed controllers is based on output voltage control with a triac voltage regulator.

Several fans may be connected to one controller if their total current does not exceed the maximum permissible controller current.

Thyristor controllers are featured with high control efficiency and accuracy. When operating in low-speed mode the fans with thyristor speed control may generate unusual noise, so the thyristor speed controllers are not recommended for low-speed applications. Low-voltage motor application results in reducing bearings service life. The recommended speed control range is 60% till 100%.

Transformer speed control.

Transformer speed controller operation is based on a five-step power transformer that regulates power supply voltage to the fan motors with permanent voltage frequency.

Transformer controllers are designed for voltage-controlled motors. Several fans may be connected to one power transformer if their total current does not exceed the maximum permissible controller current.

When operating in low-speed mode the fans with transformer speed control generate no unusual noise. However the motor bearings service life can be reduced as a result of continuous low-voltage operation mode (speed 1 or 2).

▶ Fan motors

External rotor motors

External rotor motor design is similar to asynchronous motor design but the motor rotor is located outside of the stator winding and the stator with the windings is located in the motor centre. Such original modification ensures the unit compact size. The motor shaft is placed on ball bearings that are fixed inside the stator. The impeller is attached to the rotor casing. Such design provides air cooling of the motor which allows using the fans in the wide temperature range. All the motors and impellers are statically and dynamically balanced at the manufacturing facility.

EC motor powered equipment



EC motor is an electric motor driven by electronically commutated direct current controller that has no friction or wear parts such as commutator and brushes found in standard direct current motors. This function is performed by maintenance-free EC-controller PCB. New electric motors are featured with high efficiency and the total controllable speed range. EC motor electronic controller enables extra functions as speed control depending on temperature, pressure or other parameters.

EC motor advantages:

- ▶ efficient operation at any motor speed up to zero;
- ▶ low heat emission;
- ▶ compact size due to external rotor motor design;
- ▶ maximum motor speed does not depend on the mains power supply frequency and operation both at 50 and 60 Hz is possible;
- ▶ high efficiency at low speed;
- ▶ data exchange between PC and fan enable setting and controlling operating parameters;
- ▶ central control of several fans integrated into a single system.

Custom designed software provides high accuracy control of the fans integrated into network.

The LED-display of the computer shows all the system parameters and the operation mode can be set individually for each fan in the network. Operating parameters of a specific fan integrated into the network can be centrally corrected to match the ventilation system parameters. Such technology provides adjusting the ventilation system in compliance with the customer requirements.

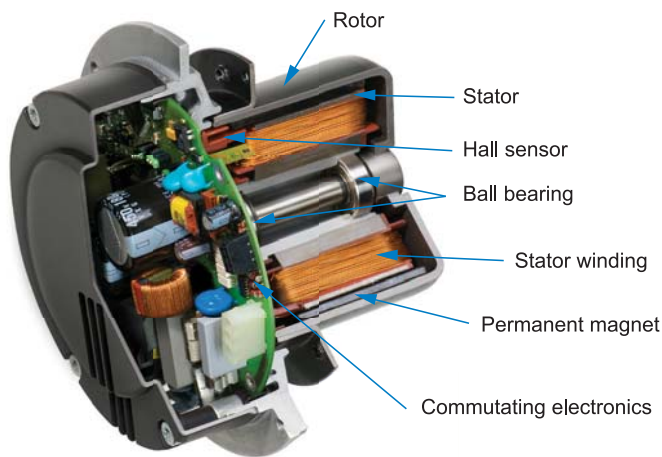

▶ General mounting recommendations

To reduce air pressure losses associated with air turbulence provide a straight air duct at the fan inlet and outlet. The minimum straight segment length must be at least 1 air duct diameter at inlet and 3 air duct diameters at outlet. No filters or other similar equipment is allowed inside the air ducts. For rectangular ducts the respective air duct diameter is calculated as follows:

$$D = \sqrt{\frac{4 \cdot H \cdot W}{\pi}}$$

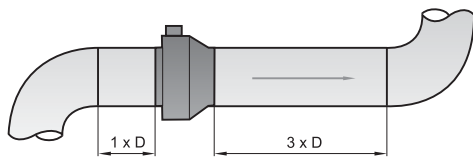

D = air duct diameter
H = air duct height
W = air duct width

▶ Fan noise characteristics

Noise characteristics of the equipment are shown in the tables indicating:

- ▶ Sound-power level LWA in dBA in frequency bands to inlet, outlet and environment of the fan.
- ▶ The total sound power level dBA at 3 m distance.

The frequency band has eight wave groups. Each group has a definite medium frequency: 63 Hz, 125 Hz, 250 Hz, 500 Hz, 1000 Hz, 2 kHz, 4 kHz and 8 kHz. Any noise is distributed to definite frequency bands and the sound energy is dissipated to various frequency.

The sound produced by the operating fan is spread along the air duct, partially attenuates inside the unit and penetrates through the grilles inside the premise. Ventilation system design is based on acoustic calculation which is an integral part of any premise ventilation design. The calculation is aimed to define the octave-frequency band in the operating points and the required sound attenuation level by means of comparing this spectrum with the permissible values according to hygienic regulations. After selection of construction and acoustic means for sound attenuation the expected sound-pressure levels are tested to check the efficiency in the selected operating points.

dBa	Characteristics	Sound source
0	no noise	
5	almost not audible	
10		low leaves rustling
15		medium leaves rustling
20	hardly audible	human whisper (1 m distance)
25		human whisper (1 m distance)
30	quiet	whisper, wall clock ticking
35		standard sound level for residential premises from 23.00 till 07.00
40	quite audible	low speech
45		conventional speech
50		standard sound level for residential premises from 07.00 till 23.00
55	definitely audible	conventional conversation
60		conversation, typing
65	noisy	standard for A office premises (EN)
70		office standard
75		loud conversation (1 m)
80		several loud conversations (1 m)
85		shout, laughter
90	very noisy	shouting, operating motorcycle with a silencer
95		loud shouting, operating motorcycle with a silencer
100		Loud shouts, freight car (7 m)
105	extremely noisy	moving subway train (7 m)
110		Orchestra, subway car (abruptly), thunder
115		Maximum permissible sound pressure for headphones of a personal stereo (according to European norms)
120		inside an airplane (before 1980s)
125		helicopter
130	almost unbearable	sandblaster (1 m)
135	Pain threshold	pneumatic hammer (1 m)
140		airplane at start

► What is IP?

While selecting equipment type and its mounting place ensure compliance of operating conditions to the indicated ingress protection parameters. Any electrical appliance must meet two ingress protection demands: ensure safety to the user and service personnel and to protect the electrical components located inside the appliance against environmental impact, i.e. Ingress Protection (IP). IP rating refers to dust-proof and moisture protection of the equipment and its electrical safety.

Information regarding protection rating marked IP and two digits indicating protection degree is specified in technical documentation and on casing of the equipment, i.e. IP20 or IP65. The first digit shows the degree of protection against access to hazardous objects. Protection characteristics defined by the first digit is stated in the table 1. The second digit shows the degree of protection against water ingress and its characteristics are stated in the table 2.







Table 1

First digit	Protection characteristics	Description
x	No ingress protection	Open construction, no dust protection and protection against contact with current-carrying parts.
1	Large-scale objects protection	Protection from objects equal to or greater than 50 mm and hand accidental touch to current-carrying parts.
2	Medium-size objects protection	Protection from objects equal to or greater than 12 mm. and fingers touch to current-carrying parts.
3	Small-size objects protection	Protection from objects equal to or greater than 2,5 mm and entry by tools, wires or fingers.
4	Sand protection	Protection from objects equal to or greater than 1 mm and entry by tools, wires or fingers.
5	Dust protection	Significant dust quantity can be accumulated inside the casing which does not disturb the rated operation. Full protection against touch to current-carrying parts.
6	Dust-tight protection	No dust penetration inside the equipment.

Table 2

Second digit	Protection characteristics	Description
x	No ingress protection	Open construction with no protection against water.
1	Protection against vertically dripping water	Water drops dripping vertically do not damage equipment.
2	Protection from vertically dripping water (15° tilted)	Water drops falling vertically at 15° do not damage equipment.
3	Protection from sprayed water	Water falling as a spray at any angle up to 60° from the vertical shall have no harmful effect.
4	Protection from splashed water	Water splashing against the enclosure from any direction shall have no harmful effects for the equipment in the casing.
5	Protection from jetting water	Water projected by a nozzle against enclosure from any direction shall have no harmful effects for the equipment in the casing.
6	Protection from powerfully jetting water	Water projected in powerful jets against the enclosure from any direction shall have no harmful effects for the equipment in the casing.
7	Protection against temporary immersion in water	Ingress of water in harmful quantity shall not be possible when the equipment is immersed in water.
8	Protection against complete, permanent immersion in water	The equipment is suitable for continuous immersion in water under conditions which shall be specified by the manufacturer.

Certification

	CE-marked equipment means that the goods are produced in compliance with the quality and safety standards provided by EU regulations for the current item (marked by the manufacturer).		Mark of conformity to the Ukrainian Quality Standards and electrical safety issued by Ukrtest.
	Mark of conformity to the European Quality Standards and electrical safety issued by Association for Technical Inspection (Technischer Überwachungsverein, Germany).		Mark of conformity of the goods subject to obligatory certification in DSTR system as well as technical norms and standards acting at Russian Federation.
	Mark of conformity to the Polish Quality Standards and electrical safety issued by PCBC (Polish center for testing and certification).		Insulation class: double insulation.
	Mark of conformity to the Slovak Quality Standards and electrical safety issued by EVPU (Slovakia).	IP 34	Appliance ingress protection rating (refer to tables 1, 2).

ENERGY-SAVING INLINE UNITS



Energy-saving units X-VENT are the best solution for ventilation and conditioning systems!

- Do you have limited space in your room?
 - Ventilating chambers are not provided?
 - Do you want to conceal the whole ventilation system under the suspended ceiling?
 - Do you need reasonable and energy-saving solution?

In this case X-VENT inline units are the best solution!

Based on inline X-VENT units you can arrange both complex and simple ventilation and conditioning systems. X-VENT units are designed for arranging any application: air supply, air exhaust, air handling with heat recovery.

Advantages of inline X-VENT units:

- ▶ Complex solution
- ▶ Complete range of products
- ▶ Small-sized and efficient
- ▶ Easy mounting
- ▶ Energy-saving technologies
- ▶ Complex automation system included into equipment list
- ▶ Low operating costs
- ▶ Easy fan maintenance and filter removal
- ▶ Long service life (at least 40 000 hours of continuous operation)
- ▶ High quality for the best price

OKW/OKW1
watercooler
(page 64)
OKF/OKF1
direct-expansion air
cooler
(page 72)

VKP...EC
centrifugal fan fan
with EC motor
(page 16)

NK/NK...U
duct electric heater
(page 42)

NKV
water heater
(page 48)

PK
bend
(page 82)

VKPF
radial fan
(page 30)

VVG flexible
connector
(page 87)

RRV
air flow controller
(page 62)

SR
silencer
(page 80)

FB
panel filter
(page 86)

PR
plate heat
exchanger
(page 86)

FBK
bag filter
(page 84)

RRV
air flow controller
(page 62)

OKW/OKF
water / direct-expansion
cooler
(page 64 / 72)

VKP...EC
centrifugal fan with
EC motor
(page 16)

PK
bend
(page 82)

NK/NK...U
duct electric heater
(page 42)

NKV
water heater
(page 48)

VKPF
radial fan
(page 30)

VVG
flexible
connector
(page 87)

RRV
air flow controller
(page 62)

SR
silencer
(page 80)

FB
panel filter
(page 86)

PR
plate heat
exchanger
(page 82)

FBK
bag filter
(page 84)

RRV
air flow controller
(page 62)

Series
VENTS VKP EC



Centrifugal fans with the air capacity up to **10850 m³/h** for rectangular ducts

■ **Applications**

Supply and exhaust ventilation and air conditioning systems for various premises requiring cost-effective solution and controlled ventilation. EC motors in VKP fan reduce energy consumption by 1, 5-3 times and ensure high performance and low noise level. Such characteristics are of special importance for ventilation of banks, supermarkets, restaurants, hotels and other public facilities including swimming pool ventilation. The fans are compatible with 600x300, 600x350, 700x400, 800x500, 900x500, 1000x500 mm rectangular ducts.

■ **Design**

Fan casing is made of galvanized steel. All inner components are interconnected by means of rivets. The fan is equipped with 20 mm standard flanges.

■ **Motor**

The impellers with backward curved blades are powered with high efficient electronically commutated (EC) direct current motors with external rotor. As of today, such motor type is the most advanced solution for energy saving. EC motors are featured by high performance and the optimal control over the whole range of fan speeds. Premium efficiency reaching up to 90% is an absolute advantage of electronically commutated motors.

■ **Integrated functions and control**

The fan is controlled with the external control signal 0-10 V (air capacity as a function of temperature level, pressure and smoke conditions etc). Should the control value factor get changed the EC motor changes its speed and the fan boosts as much air capacity to the ventilation system as required. Maximum speed of the fan does not depend on the current frequency and it can operate at 50 or 60 Hz mains supply. The fans can be integrated to the unified PC control system. The respective software allows controlling all the fan units with high accuracy and setting particular operation mode for each fan.

■ **Mounting**

The fans are mounted into the rectangular ducts and require no special fixing in case of direct connection. In case of connection through the flexible connectors the fan is fixed to a building by means of supports, suspension brackets or fixation brackets. The fans can be mounted in any position with respect to the airflow direction which is indicated with a pointer on the casing. Access for the fan maintenance shall be provided. The casing is provided with the removable access door for inspection and maintenance purposes.

Technical data:

	VKP 600x300 EC	VKP 600x350 EC	VKP 700x400 EC	VKP 800x500 EC	VKP 900x500 EC	VKP 1000x500 EC
Voltage [V / 50/60 Hz]	1~ 200-277	3~ 380-480	3~ 380-480	3~ 380-480	3~ 380-480	3~ 380-480
Power [kW]	0.48	0.99	1.70	2.95	2.98	2.98
Current [A]	3.10	1.70	2.60	4.60	4.60	4.60
Max. air capacity [m ³ /h]	3350	4550	6300	8900	10850	10850
RPM [min ⁻¹]	2300	2580	2600	2500	2040	2040
Noise level at 3 m [dBA]	58	60	63	65	69	69
Transported air temperature [°C]	-25 +60	-25 +50	-25 +40	-25 +40	-25 +40	-25 +40
Protection rating	IP X4	IP X4	IP X4	IP X4	IP X4	IP X4

Designation key:

Series	Flange diameter [WxH]	Motor
VENTS VKP	600x300, 600x350, 700x400, 800x500, 900x500, 1000x500	EC – synchronous electronically commutated motor

ErP data	
Overall efficiency	η, [%]
Measurement category	MC
Efficiency category	EC
Efficiency grade	N
Variable speed drive	VSD
Power	[kW]
Current	[A]
Air flow	[m ³ /h]
Static pressure	[Pa]
Speed	[n/min ⁻¹]
Specific ratio	SR

Accessories



page 80 page 80 page 86 page 84 page 42 page 48 page 62 page 63 page 87

Fan overall dimensions:

Type	Dimensions [mm]								Weight [kg]
	B	B1	B2	H	H1	H2	H3	L	
VKP 600x300 EC	600	620	640	300	320	340	430	680	35.0
VKP 600x350 EC	600	620	640	350	370	390	480	735	49.5
VKP 700x400 EC	700	720	740	400	420	440	540	780	60.0
VKP 800x500 EC	800	820	840	500	520	540	640	880	68.8
VKP 900x500 EC	900	920	940	500	520	540	640	954	90.0
VKP 1000x500 EC	1000	1020	1040	500	520	540	640	954	95.0

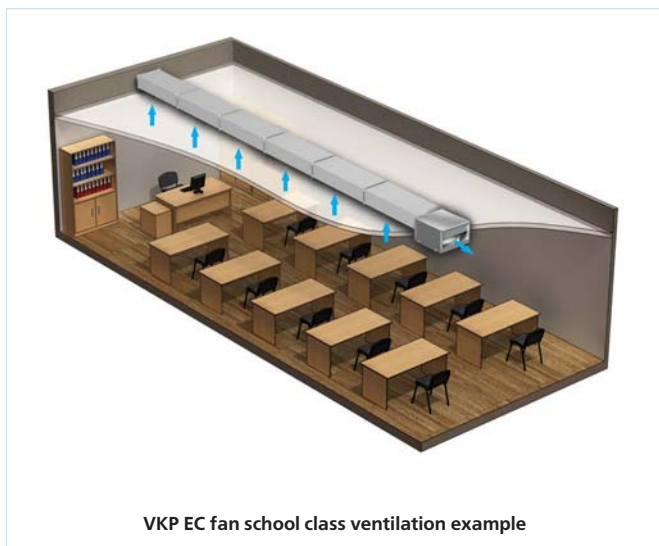
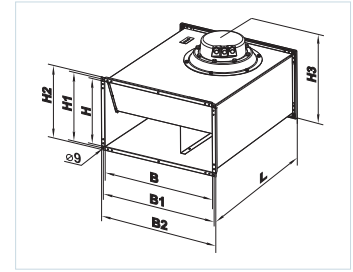

VKP EC fan school class ventilation example

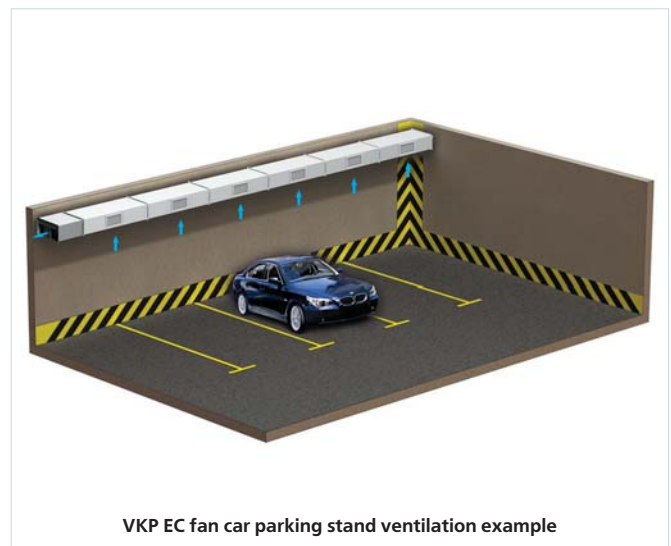

VKP EC fan car parking stand ventilation example

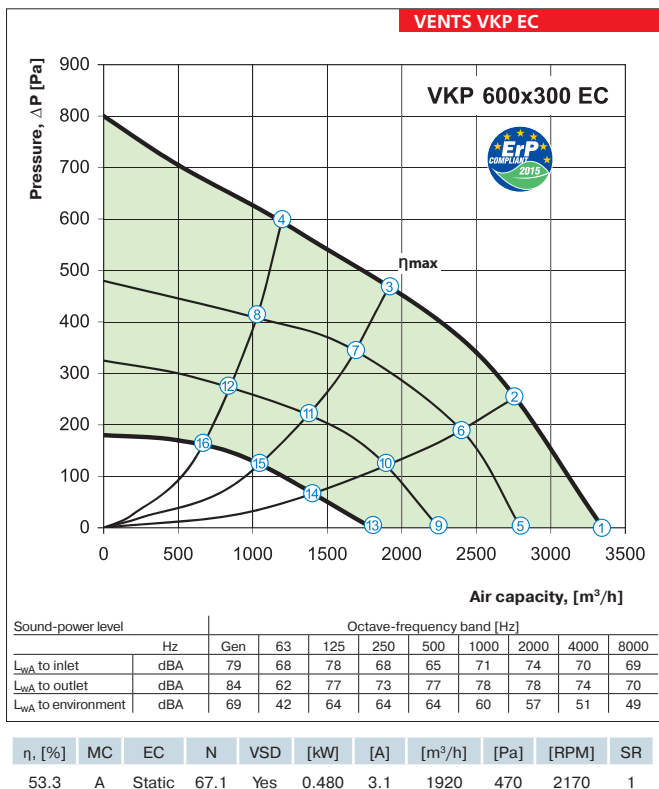

point	P, (W)	I, (A)	n, (min ⁻¹)
1	370	2.35	2300
2	445	2.85	2215
3	480	3.10	2170
4	448	2.85	2220
5	210	1.30	1900
6	284	1.70	1900
7	312	1.80	1900
8	278	1.70	1900
9	124	0.80	1560
10	158	1.00	1560
11	175	1.10	1560
12	158	1.00	1560
13	57	0.40	1200
14	73	0.50	1200
15	80	0.50	1200
16	70	0.50	1200

RECTANGULAR INLINE FANS

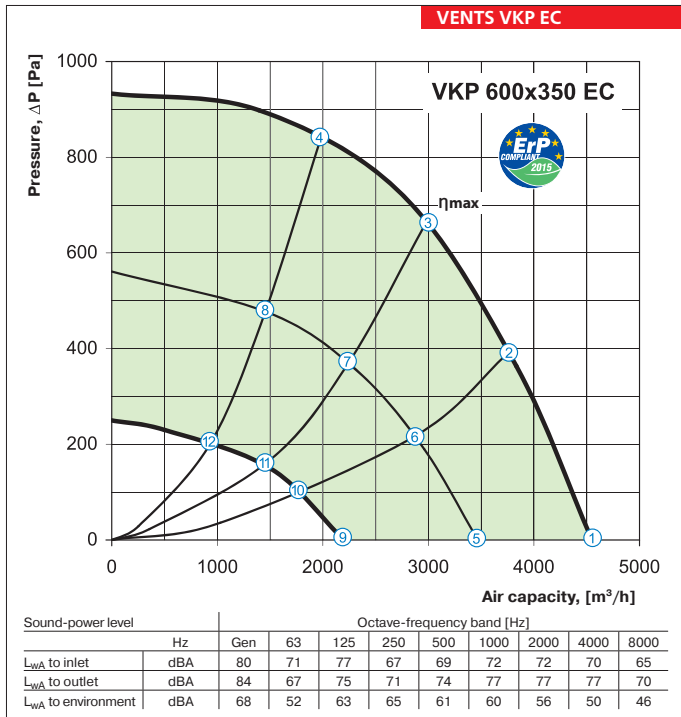

point	P, (W)	I, (A)	n, (min ⁻¹)
1	669	1.17	2580
2	862	1.46	2580
3	990	1.70	2580
4	907	1.53	2580
5	288	0.57	1930
6	348	0.69	1910
7	396	0.77	1900
8	360	0.72	1905
9	123	0.28	1305
10	144	0.33	1305
11	151	0.34	1305
12	151	0.34	1300

η, [%]	MC	EC	N	VSD	[kW]	[A]	[m ³ /h]	[Pa]	[RPM]	SR
56.6	A	Static	67.2	Yes	0.990	1.7	2979	664	2580	1

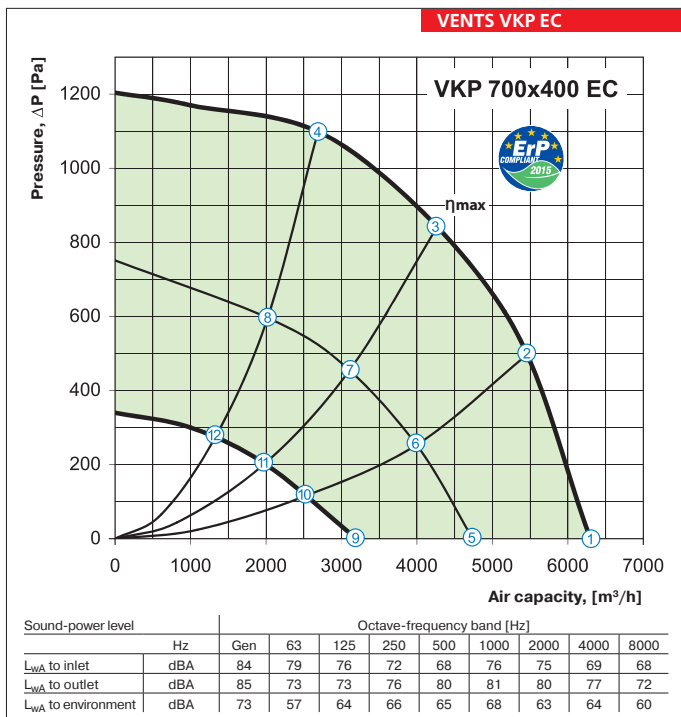

point	P, (W)	I, (A)	n, (min ⁻¹)
1	1140	1.74	2600
2	1510	2.30	2600
3	1700	2.60	2600
4	1594	2.42	2600
5	436	0.73	1940
6	541	0.88	1910
7	533	0.95	1885
8	558	0.91	1905
9	194	0.40	1330
10	226	0.45	1315
11	239	0.47	1305
12	236	0.46	1305

η, [%]	MC	EC	N	VSD	[kW]	[A]	[m ³ /h]	[Pa]	[RPM]	SR
59.9	A	Static	68	Yes	1.700	2.6	4270	842	2600	1

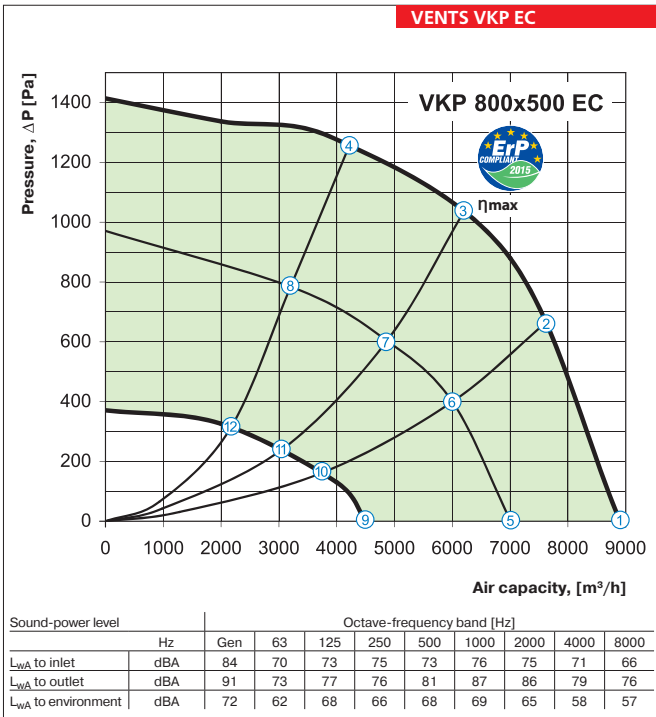

η , [%]	MC	EC	N	VSD	[kW]	[A]	[m ³ /h]	[Pa]	[RPM]	SR
62	A	Static	67.6	Yes	2.950	4.6	6210	1039	2500	1

point	P, (W)	I, (A)	n, (min ⁻¹)
1	2009	3.07	2500
2	2738	4.19	2500
3	2950	4.60	2500
4	2748	4.20	2500
5	945	1.48	1945
6	1170	1.80	1920
7	1247	1.91	1915
8	1193	1.84	1920
9	308	0.59	1255
10	416	0.76	1260
11	417	0.77	1255
12	410	0.75	1255

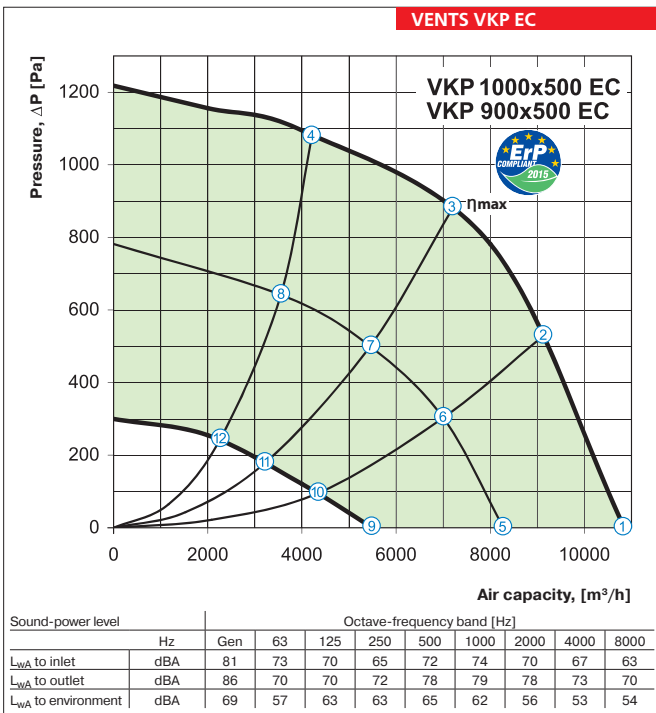

η , [%]	MC	EC	N	VSD	[kW]	[A]	[m ³ /h]	[Pa]	[RPM]	SR
60.5	A	Static	66	Yes	2.980	4.6	7210	882	2040	1

point	P, (W)	I, (A)	n, (min ⁻¹)
1	1988	3.00	2040
2	2596	3.94	2040
3	2980	4.60	2040
4	2638	3.99	2040
5	818	1.28	1550
6	1054	1.63	1545
7	1195	1.83	1550
8	1075	1.66	1570
9	313	0.60	1045
10	362	0.70	1025
11	387	0.72	1010
12	362	0.69	1005

Series
VENTS VKP



Centrifugal fans with the air capacity up to **2970 m³/h** for rectangular ducts

Series
VENTS VKP 4D 1000x500



Centrifugal fans with the air capacity up to **15000 m³/h** for rectangular ducts

Series
VENTS VKPI



Centrifugal sound- and heat-insulated fans with the air capacity up to **2970 m³/h** for rectangular ducts

■ **Applications**

Supply and exhaust ventilation systems for various premises with a limited mounting space. For connection with 400x200, 500x250, 500x300, 600x300, 600x350, 1000x500 mm the rectangular ducts.

■ **Design**

Fan casing is made of galvanized steel. VKPI models are sound- and heat-insulated with 50 mm mineral wool layer.

■ **Motor**

Impellers with backward curved impeller blades made of galvanized steel are powered by means of the 2- or 4-pole asynchronous motors with external rotor. Motors are supplied with incorporated overheating

protection with automatic restart or the thermal protection terminals leaded outside for connection to the external protection devices depending on the model, see the wiring diagram motor is equipped with ball bearings for long service life. For precise features, safe operation and low noise, each impeller is dynamically balanced while assembly. Motor protection rating IP 44.

■ **Speed control**

Smooth or step speed control with a thyristor or autotransformer speed controller. Several fans may be connected to one speed controller provided that the total power and operating current do not exceed the rated speed controller parameters.

■ **Mounting**

The fans are mounted into the rectangular ducts and require no special fixing in case of direct connection. In case of connection through the flexible connectors the fan is fixed to a building by means of supports, suspension brackets or fixation brackets. Fans can be mounted in any position with respect to the airflow direction (indicated with an arrow on the casing). Access for the fan maintenance shall be provided. The fan is powered through the external terminals. The casing is equipped with the removable access cover for maintenance purposes.

Designation key: _____

Series		Motor modification		Flange diameter [WxH]
		Number of poles	Phase	
VENTS VKP	I – sound- and heat-insulated casing	2	E – single phase	400x200, 500x250, 500x300, 600x300, 600x350, 1000x500
		4	D – three phase	

ErP data	
Overall efficiency	η, [%]
Measurement category	MC
Efficiency category	EC
Efficiency grade	N
Variable speed drive	VSD
Power	[kW]
Current	[A]
Air flow	[m ³ /h]
Static pressure	[Pa]
Speed	[n/min ⁻¹]
Specific ratio	SR

Accessories



page 80 page 80 page 86 page 84 page 42 page 48 page 62 page 63 page 87 page 88 page 89

Technical data:

	VKP / VKPI 2E 400x200 	VKP / VKPI 2E 500x250	VKP / VKPI 4E 500x300
Voltage [V / 50 Hz]	230	230	230
Power [W]	138	305	140
Current [A]	0.60	1.32	0.57
Max. air capacity [m ³ /h]	930	1720	1700
RPM [min ⁻¹]	2600	2550	1390
Noise level at 3 m [dBA]	59 / 51*	61 / 53*	53 / 45*
Transported air temperature [°C]	-25 +45	-25 +45	-25 +45
Protection rating	IPX4	IPX4	IPX4



* parameter for VKPI fan

Technical data:

	VKP / VKPI 4D 500x300	VKP / VKPI 4E 600x300	VKP / VKPI 4D 600x300 
Voltage [V / 50 Hz]	400	230	400
Power [W]	136	220	230
Current [A]	0.34	0.90	0.52
Max. air capacity [m ³ /h]	1380	2470	2530
RPM [min ⁻¹]	1360	1400	1360
Noise level at 3 m [dBA]	53 / 45*	55 / 47*	53 / 46*
Transported air temperature [°C]	-25 +65	-25 +45	-25 +70
Protection rating	IPX4	IPX4	IPX4

* parameter for VKPI fan

Technical data:

	VKP / VKPI 4E 600x350 	VKP / VKPI 4D 600x350 	VKP 4D 1000x500 	
Voltage [V / 50 Hz]	230	400Δ	400Y	3~ 400
Power [W]	470	510	380	3800
Current [A]	2.37	1.41	0.70	6.6
Max. air capacity [m ³ /h]	2950	2970	2660	15000
RPM [min ⁻¹]	1370	1415	1235	1360
Noise level at 3 m [dBA]	67 / 59*	64 / 55*	63 / 55*	70
Transported air temperature [°C]	-40 +80	-40 +60	-40 +80	-20 +40
Protection rating	IPX4	IPX4	IP X4	

* parameter for VKPI fan

RECTANGULAR INLINE FANS

Fan overall dimensions:

Type	Dimensions [mm]								Weight [kg]
	B	B1	B2	H	H1	H2	H3	L	
VKP 2E 400x200	400	420	440	200	220	240	240	500	11.25
VKP 2E 500x250	500	520	540	250	270	290	290	640	17.88
VKP 4E 500x300	500	520	540	300	320	340	340	680	19.8
VKP 4D 500x300	500	520	540	300	320	340	340	680	19.8
VKP 4E 600x300	600	620	640	300	320	340	342	680	27.77
VKP 4D 600x300	600	620	640	300	320	340	342	680	27.77
VKP 4E 600x350	600	620	640	350	370	390	390	735	36.38
VKP 4D 600x350	600	620	640	350	370	390	390	735	36.38

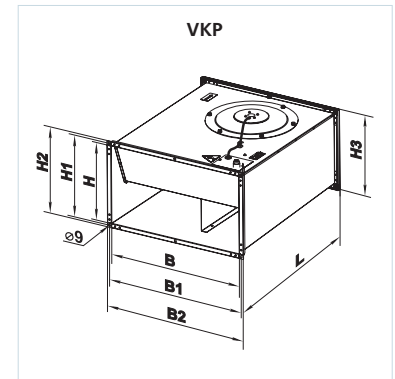

Fan overall dimensions:

Type	Dimensions [mm]								Weight [kg]
	B	B1	B2	H	H1	H2	H3	L	
VKP 4D 1000x500	1000	1020	1040	500	520	540	720	1150	126.0

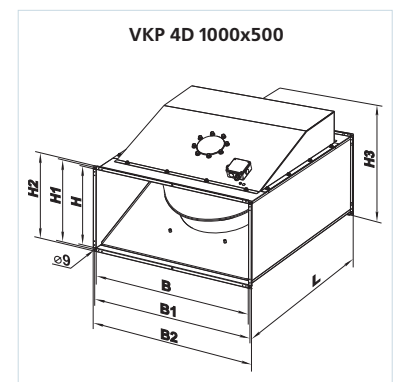

Fan overall dimensions:

Type	Dimensions [mm]									Weight [kg]
	B	B1	B2	B3	H	H1	H2	H3	L	
VKPI 2E 400x200	400	420	440	500	200	220	240	360	500	24.5
VKPI 2E 500x250	500	520	540	600	250	270	290	410	640	27.6
VKPI 4E 500x300	500	520	540	600	300	320	340	460	680	37.2
VKPI 4D 500x300	500	520	540	600	300	320	340	460	680	37.2
VKPI 4E 600x300	600	620	640	700	300	320	340	460	680	43.5
VKPI 4D 600x300	600	620	640	700	300	320	340	460	680	43.5
VKPI 4E 600x350	600	620	640	700	350	370	390	530	735	56.2
VKPI 4D 600x350	600	620	640	700	350	370	390	530	735	56.2

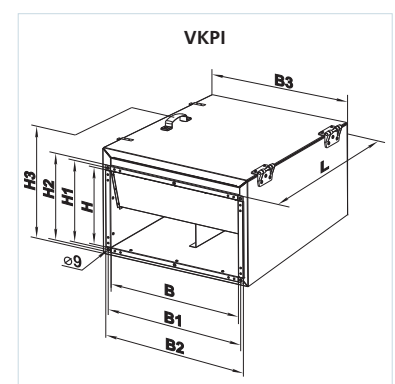

VENTS VKP / VKPI

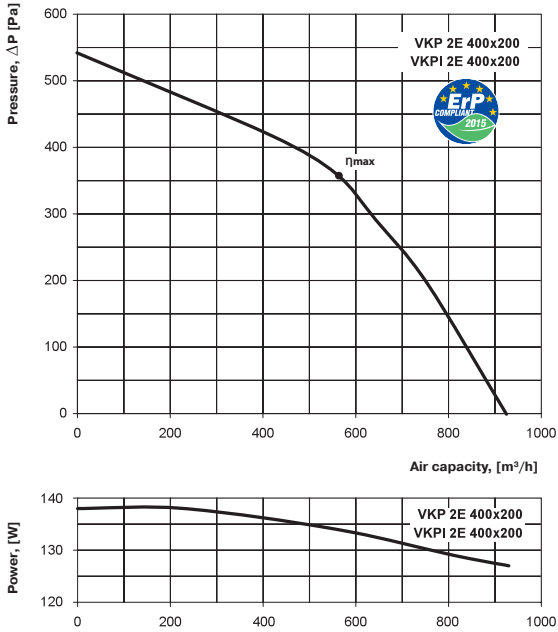

VKP 2E 400x200

		Octave-frequency band [Hz]									
		Hz	Gen	63	125	250	500	1000	2000	4000	8000
L_{WA} to inlet	dBA	71	54	63	68	64	64	58	54	45	
L_{WA} to outlet	dBA	75	53	62	66	68	69	66	60	48	
L_{WA} to environment	dBA	58	36	48	56	54	50	46	41	32	

VKPI 2E 400x200

		Octave-frequency band [Hz]									
		Hz	Gen	63	125	250	500	1000	2000	4000	8000
L_{WA} to inlet	dBA	65	45	57	60	60	57	53	49	43	
L_{WA} to outlet	dBA	70	47	59	61	66	64	60	55	43	
L_{WA} to environment	dBA	48	26	37	45	43	35	32	29	22	

VENTS VKP / VKPI

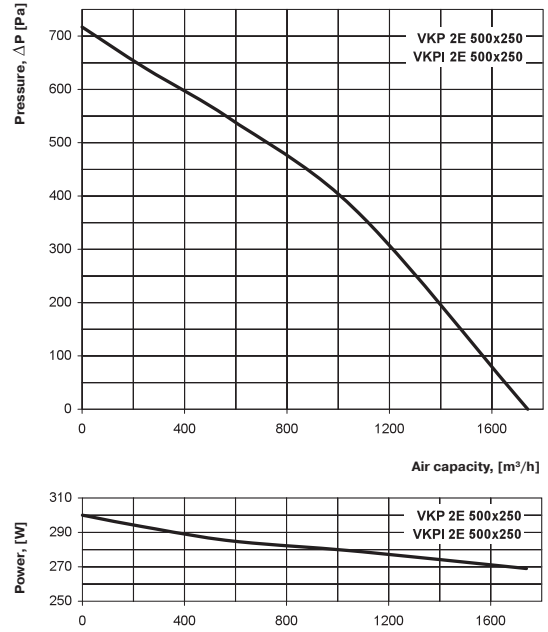

VKP 2E 500x250

		Octave-frequency band [Hz]									
		Hz	Gen	63	125	250	500	1000	2000	4000	8000
L_{WA} to inlet	dBA	69	60	68	60	56	56	49	46	46	
L_{WA} to outlet	dBA	70	54	65	64	63	60	56	49	44	
L_{WA} to environment	dBA	53	41	48	47	44	40	38	33	35	

VKPI 2E 500x250

		Octave-frequency band [Hz]									
		Hz	Gen	63	125	250	500	1000	2000	4000	8000
L_{WA} to inlet	dBA	62	52	60	56	51	50	43	42	40	
L_{WA} to outlet	dBA	63	48	59	60	55	57	53	45	39	
L_{WA} to environment	dBA	41	27	35	37	31	29	27	25	27	

VENTS VKP / VKPI

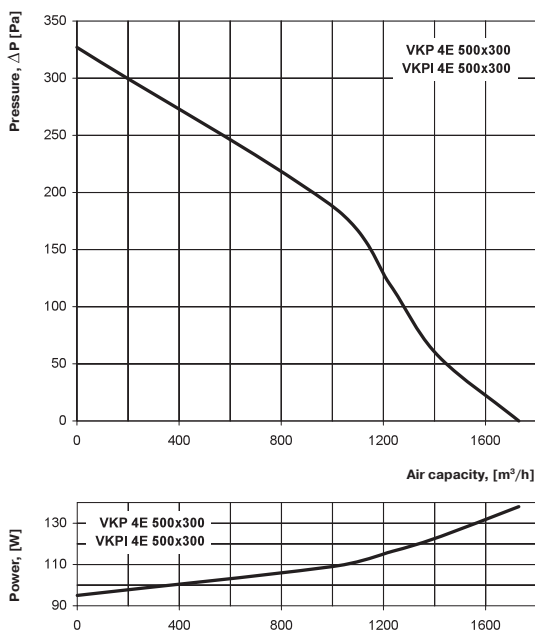

VKP 4E 500x300

		Octave-frequency band [Hz]									
		Hz	Gen	63	125	250	500	1000	2000	4000	8000
L_{WA} to inlet	dBA	69	58	63	64	55	57	58	51	46	
L_{WA} to outlet	dBA	73	57	60	72	65	65	64	57	48	
L_{WA} to environment	dBA	56	44	52	51	51	49	48	43	33	

VKPI 4E 500x300

		Octave-frequency band [Hz]									
		Hz	Gen	63	125	250	500	1000	2000	4000	8000
L_{WA} to inlet	dBA	64	51	59	60	48	55	51	49	40	
L_{WA} to outlet	dBA	70	50	55	64	59	62	59	50	43	
L_{WA} to environment	dBA	44	31	37	40	39	38	35	32	20	

VKP 2E 400x200

η , [%]	MC	EC	N	VSD	[kW]	[A]	[m ³ /h]	[Pa]	[RPM]	SR
38.9	A	Static	58.1	No	0.148	0.65	560	362	2550	1

RECTANGULAR INLINE FANS

VENTS VKP / VKPI

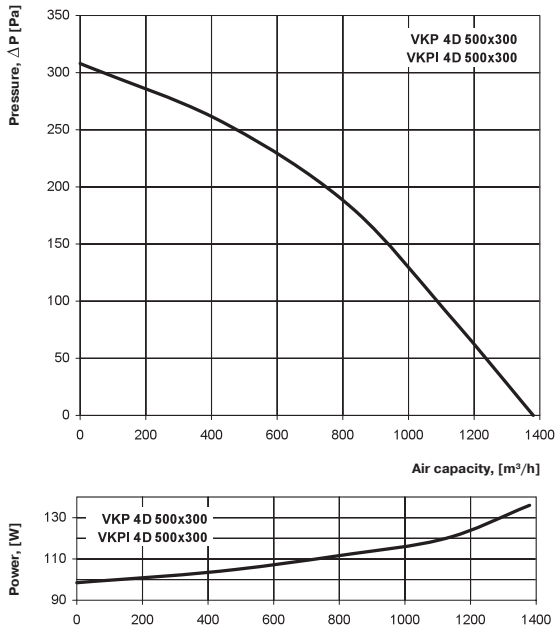

VKP 4D 500x300

Sound-power level	Hz	Octave-frequency band [Hz]								
		Gen	63	125	250	500	1000	2000	4000	8000
L _{WA} to inlet	dBA	69	58	62	65	55	58	58	55	45
L _{WA} to outlet	dBA	71	56	62	69	64	66	63	59	50
L _{WA} to environment	dBA	55	42	51	51	52	52	48	43	32

VKPI 4D 500x300

Sound-power level	Hz	Octave-frequency band [Hz]								
		Gen	63	125	250	500	1000	2000	4000	8000
L _{WA} to inlet	dBA	62	51	59	63	49	55	54	49	39
L _{WA} to outlet	dBA	66	51	57	67	59	63	60	50	42
L _{WA} to environment	dBA	44	31	38	38	38	36	38	31	22

VENTS VKP / VKPI

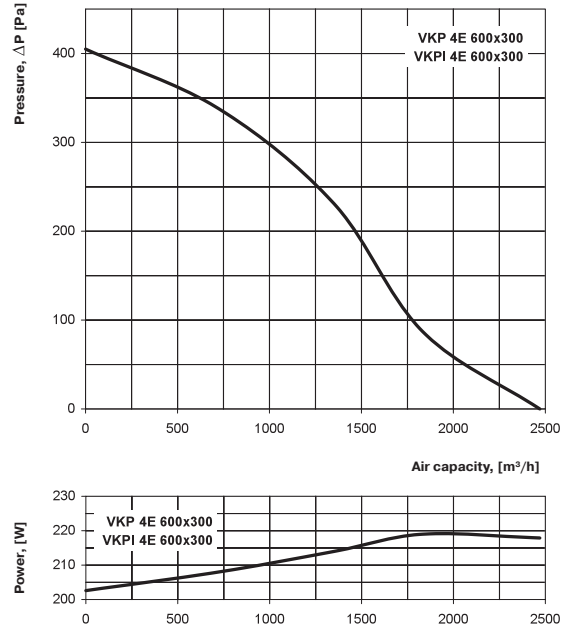

VKP 4E 600x300

Sound-power level	Hz	Octave-frequency band [Hz]								
		Gen	63	125	250	500	1000	2000	4000	8000
L _{WA} to inlet	dBA	72	63	67	69	56	61	61	54	48
L _{WA} to outlet	dBA	78	57	65	73	68	69	69	61	54
L _{WA} to environment	dBA	61	43	55	54	55	53	49	48	35

VKPI 4E 600x300

Sound-power level	Hz	Octave-frequency band [Hz]								
		Gen	63	125	250	500	1000	2000	4000	8000
L _{WA} to inlet	dBA	68	58	62	64	55	55	53	51	42
L _{WA} to outlet	dBA	71	54	60	67	62	64	61	54	49
L _{WA} to environment	dBA	48	34	42	43	41	40	37	36	23

VENTS VKP / VKPI

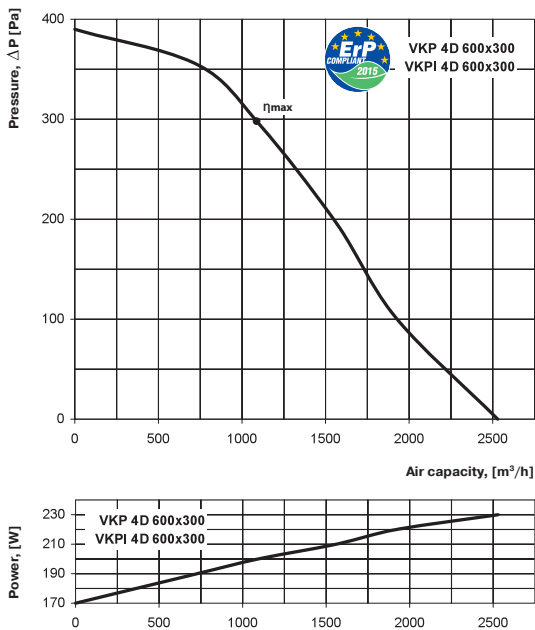

VKP 4D 600x300

Sound-power level	Hz	Octave-frequency band [Hz]								
		Gen	63	125	250	500	1000	2000	4000	8000
L _{WA} to inlet	dBA	72	61	69	67	60	62	58	56	50
L _{WA} to outlet	dBA	76	59	66	73	68	69	66	58	51
L _{WA} to environment	dBA	59	45	53	56	54	54	53	47	38

VKPI 4D 600x300

Sound-power level	Hz	Octave-frequency band [Hz]								
		Gen	63	125	250	500	1000	2000	4000	8000
L _{WA} to inlet	dBA	69	55	60	66	53	55	56	52	43
L _{WA} to outlet	dBA	71	56	61	70	62	65	60	55	45
L _{WA} to environment	dBA	46	31	43	41	40	41	40	35	23

VKP 4D 600x300

η, [%]	MC	EC	N	VSD	[kW]	[A]	[m³/h]	[Pa]	[RPM]	SR
44.1	A	Static	61.7	No	0.209	0.65	1094	297	1375	1

VENTS VKP / VKPI

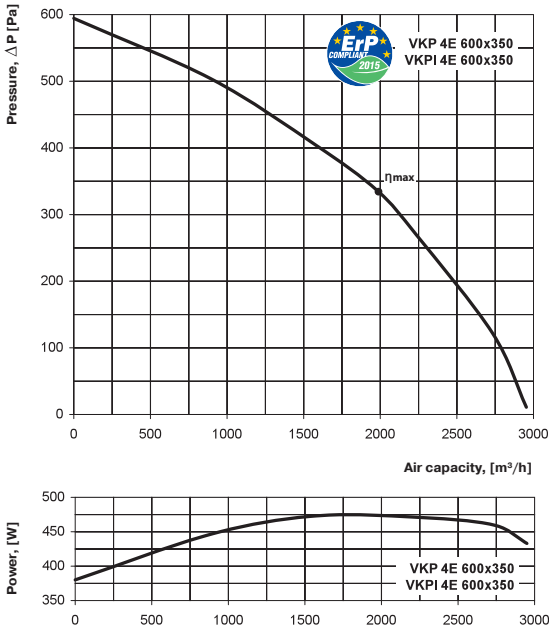

VKP 4E 600x350

Sound-power level	Hz	Octave-frequency band [Hz]								
		Gen	63	125	250	500	1000	2000	4000	8000
L _{WA} to inlet	dBA	78	58	78	75	60	64	65	67	55
L _{WA} to outlet	dBA	79	58	69	75	67	70	69	69	56
L _{WA} to environment	dBA	64	37	61	55	51	54	49	43	35

VKPI 4E 600x350

Sound-power level	Hz	Octave-frequency band [Hz]								
		Gen	63	125	250	500	1000	2000	4000	8000
L _{WA} to inlet	dBA	75	53	72	71	54	58	63	60	52
L _{WA} to outlet	dBA	74	52	62	69	62	67	65	64	54
L _{WA} to environment	dBA	51	25	51	44	40	42	38	34	23

VENTS VKP / VKPI

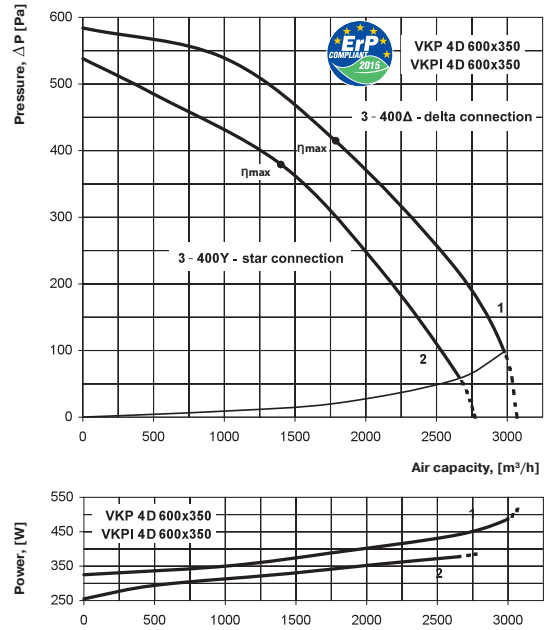

VKP 4D 600x350

Sound-power level	Hz	Octave-frequency band [Hz]								
		Gen	63	125	250	500	1000	2000	4000	8000
L _{WA} to inlet	dBA	72	57	59	72	66	64	65	58	47
L _{WA} to outlet	dBA	81	60	67	76	74	74	69	59	50
L _{WA} to environment	dBA	65	40	53	61	57	55	54	47	38

VKPI 4D 600x350

Sound-power level	Hz	Octave-frequency band [Hz]								
		Gen	63	125	250	500	1000	2000	4000	8000
L _{WA} to inlet	dBA	70	54	56	65	62	60	58	49	40
L _{WA} to outlet	dBA	74	57	63	73	70	68	65	57	47
L _{WA} to environment	dBA	52	27	41	50	43	45	41	35	26

VENTS VKP

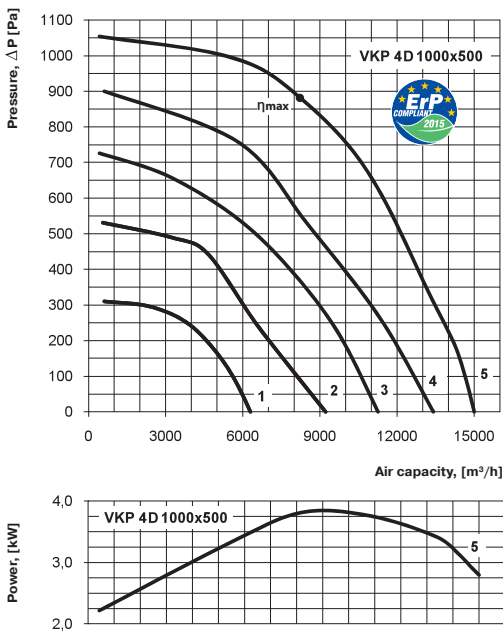

Sound-power level	Hz	Octave-frequency band [Hz]								
		Gen	63	125	250	500	1000	2000	4000	8000
L _{WA} to inlet	dBA	75	71	74	73	73	71	72	67	65
L _{WA} to outlet	dBA	88	69	77	82	82	84	79	74	68
L _{WA} to environment	dBA	72	58	63	63	62	64	61	57	52

VKP 4E 600x350

η _i [%]	MC	EC	N	VSD	[kW]	[A]	[m³/h]	[Pa]	[RPM]	SR
43.7	A	Static	58.1	No	0.430	2.17	1980	335	1390	1

VKP 4D 600x350

η _i [%]	MC	EC	N	VSD	[kW]	[A]	[m³/h]	[Pa]	[RPM]	SR
3~ 400Δ - delta connection										
49.5	A	Static	64	No	0.424	1.32	1799	412	1415	1
3~ 400Y - star connection										
45.7	A	Static	61.3	No	0.330	0.55	1409	378	1380	1

VKP 4D 1000x500

η _i [%]	MC	EC	N	VSD	[kW]	[A]	[m³/h]	[Pa]	[RPM]	SR
55.5	A	Static	60.1	No	3.710	6.1	8260	880	1360	1

Series
VENTS VKPI EC



Centrifugal fans with the air capacity up to **10850 m³/h** for rectangular ducts

Applications

Supply and exhaust ventilation and air conditioning systems for various premises requiring cost-effective solution and controlled ventilation. EC motors in VKPI fan reduce energy consumption by 1.5-3 times and

ensure high performance and low noise level. Such characteristics are of special importance for ventilation of banks, supermarkets, restaurants, hotels and other public facilities including swimming pool ventilation. The fans are compatible with 600x300, 600x350, 700x400, 800x500, 900x500, 1000x500 mm rectangular ducts.

Design

Fan casing is made of galvanized steel and is heat- and sound-insulated with 50 mm mineral wool layer. All inner components are interconnected by means of rivets. The fan is equipped with 20 mm standard flanges.

Motor

The impellers with backward curved blades are powered with high efficient electronically commutated (EC) direct current motors with external rotor. As of today, such motor type is the most advanced solution for energy saving. EC motors are featured by high performance and the optimal control over the whole range of fan speeds. Premium efficiency reaching up to 90% is an absolute advantage of electronically commutated motors.

Integrated functions and control

The fan is controlled with the external control signal 0-10 V (air capacity as a function of temperature level, pressure and smoke conditions etc). Should the control value factor get changed the EC motor changes its speed and the fan boosts as much air capacity to the ventilation system as required. Maximum speed of the fan does not depend on the current frequency and it can operate at 50 or 60 Hz mains supply. The fans can be integrated to the unified PC control system. The respective software allows controlling all the fan units with high accuracy and setting particular operation mode for each fan.

Mounting

The fans are mounted into the rectangular ducts and require no special fixing in case of direct connection. In case of connection through the flexible connectors the fan is fixed to a building by means of supports, suspension brackets or fixation brackets. The fans can be mounted in any position with respect to the airflow direction which is indicated with a pointer on the casing. Access for the fan maintenance shall be provided. The casing is provided with the removable access door for inspection and maintenance purposes.

Technical data:

	VKPI 600x300 EC	VKPI 600x350 EC	VKPI 700x400 EC	VKPI 800x500 EC	VKPI 900x500 EC	VKPI 1000x500 EC
Voltage [V / 50/60 Hz]	1~ 200-277	3~ 380-480	3~ 380-480	3~ 380-480	3~ 380-480	3~ 380-480
Power [kW]	0.48	0.99	1.70	2.95	2.98	2.98
Current [A]	3.10	1.70	2.60	4.60	4.60	4.60
Max. air capacity [m ³ /h]	3350	4550	6300	8900	10850	10850
RPM [min ⁻¹]	2300	2580	2600	2500	2040	2040
Noise level at 3 m [dBA]	49	51	54	57	60	60
Transported air temperature [°C]	-25 +60	-25 +50	-25 +40	-25 +40	-25 +40	-25 +40
Protection rating	IP X4	IP X4	IP X4	IP X4	IP X4	IP X4

Designation key:

Series	Flange diameter [WxH]	Motor
VENTS VKPI	600x300, 600x350, 700x400, 800x500, 900x500, 1000x500	EC – synchronous electronically commutated motor

ErP data	
Overall efficiency	η, [%]
Measurement category	MC
Efficiency category	EC
Efficiency grade	N
Variable speed drive	VSD
Power	[kW]
Current	[A]
Air flow	[m ³ /h]
Static pressure	[Pa]
Speed	[n/min ⁻¹]
Specific ratio	SR

Accessories



page 80 page 80 page 86 page 84 page 42 page 48 page 62 page 63 page 87

Fan overall dimensions:

Type	Dimensions [mm]									Weight [kg]
	B	H	B1	H1	B3	H3	L	G	K	
VKPI 600x300 EC	600	300	620	320	775	530	752	745	500	55.0
VKPI 600x350 EC	600	350	620	370	775	630	802	745	500	65.0
VKPI 700x400 EC	700	400	720	420	875	690	880	845	742	90.0
VKPI 800x500 EC	800	500	820	520	975	810	935	945	800	124.1
VKPI 900x500 EC	900	500	920	520	1075	810	1000	1045	800	128.0
VKPI 1000x500 EC	1000	500	1020	520	1175	810	1000	1145	800	129.0

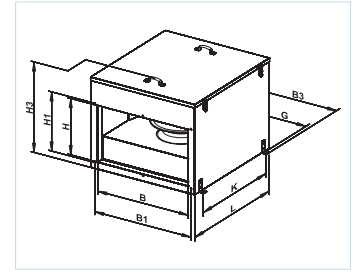

VKPI EC fan school class ventilation example

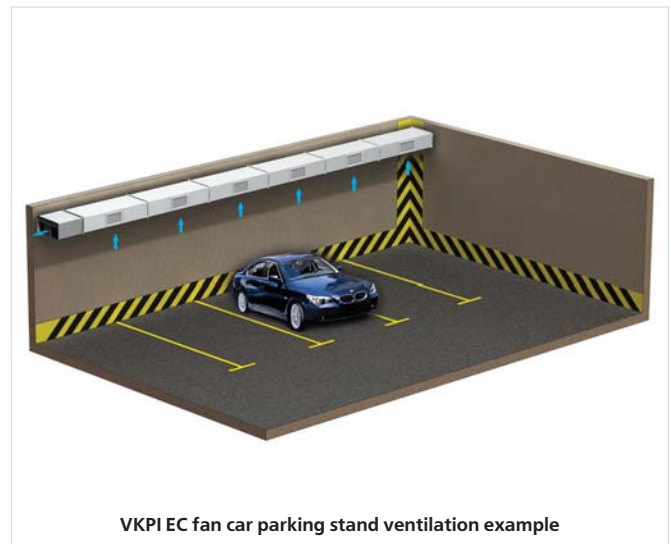

VKPI EC fan car parking stand ventilation example

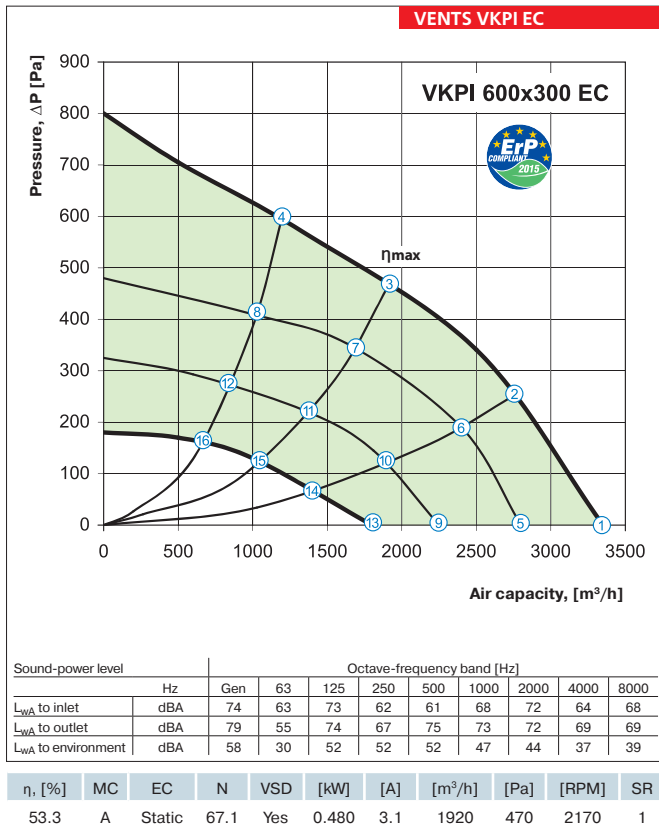

point	P, (W)	I, (A)	n, (min ⁻¹)
1	370	2.35	2300
2	445	2.85	2215
3	480	3.10	2170
4	448	2.85	2220
5	210	1.30	1900
6	284	1.70	1900
7	312	1.80	1900
8	278	1.70	1900
9	124	0.80	1560
10	158	1.00	1560
11	175	1.10	1560
12	158	1.00	1560
13	57	0.40	1200
14	73	0.50	1200
15	80	0.50	1200
16	70	0.50	1200

RECTANGULAR INLINE FANS

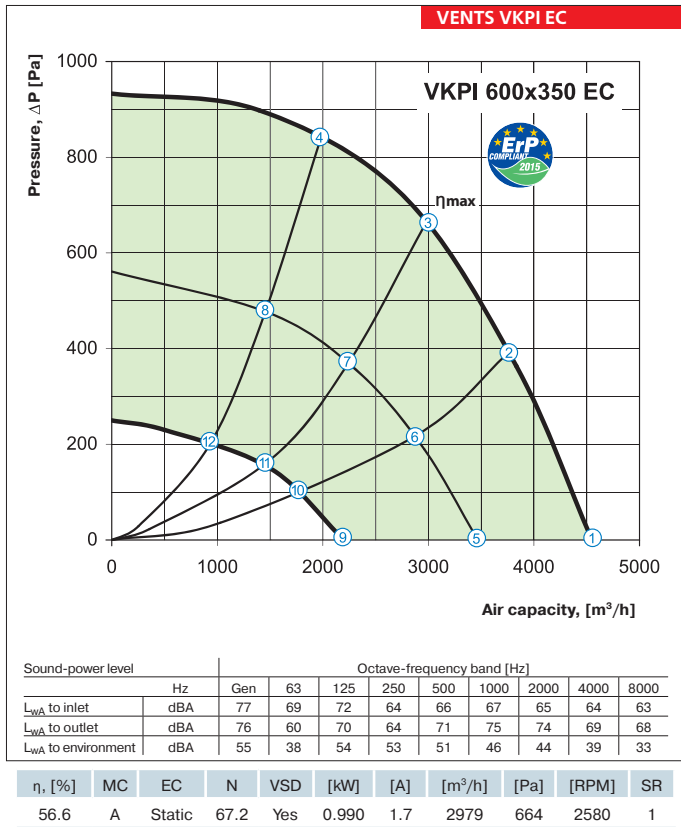

point	P, (W)	I, (A)	n, (min ⁻¹)
1	669	1.17	2580
2	862	1.46	2580
3	990	1.70	2580
4	907	1.53	2580
5	288	0.57	1930
6	348	0.69	1910
7	396	0.77	1900
8	360	0.72	1905
9	123	0.28	1305
10	144	0.33	1305
11	151	0.34	1305
12	151	0.34	1300

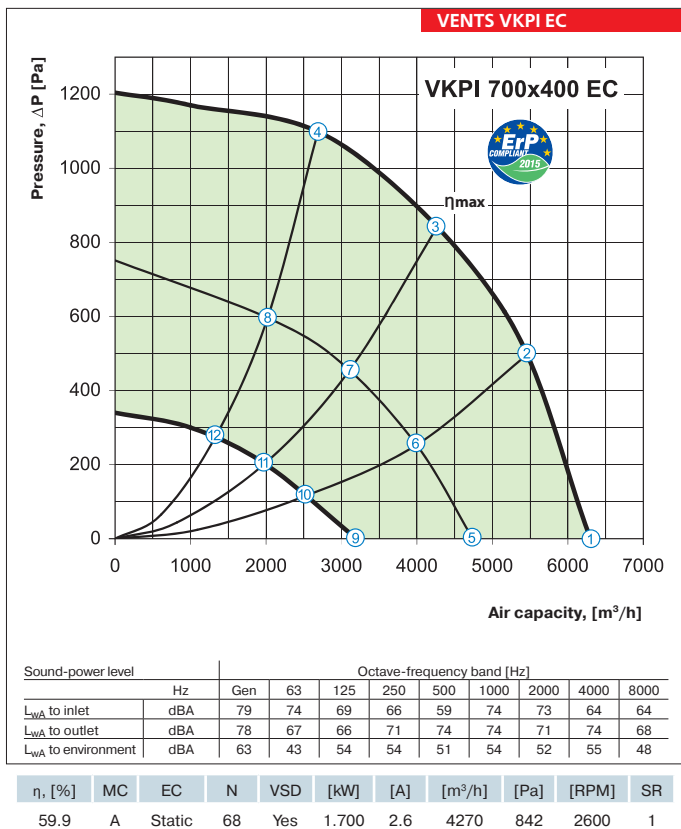

point	P, (W)	I, (A)	n, (min ⁻¹)
1	1140	1.74	2600
2	1510	2.30	2600
3	1700	2.60	2600
4	1594	2.42	2600
5	436	0.73	1940
6	541	0.88	1910
7	533	0.95	1885
8	558	0.91	1905
9	194	0.40	1330
10	226	0.45	1315
11	239	0.47	1305
12	236	0.46	1305

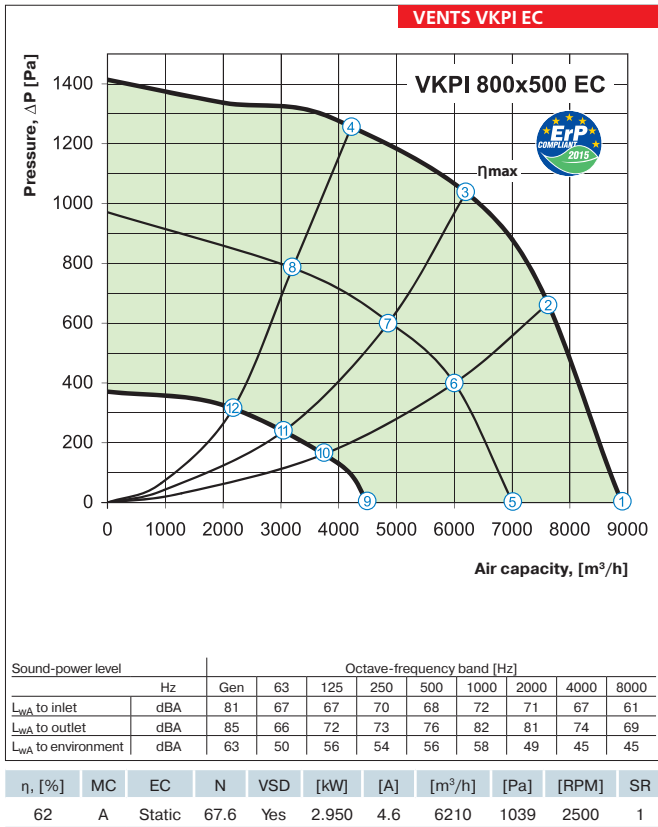

point	P, (W)	I, (A)	n, (min ⁻¹)
1	2009	3.07	2500
2	2738	4.19	2500
3	2950	4.60	2500
4	2748	4.20	2500
5	945	1.48	1945
6	1170	1.80	1920
7	1247	1.91	1915
8	1193	1.84	1920
9	308	0.59	1255
10	416	0.76	1260
11	417	0.77	1255
12	410	0.75	1255

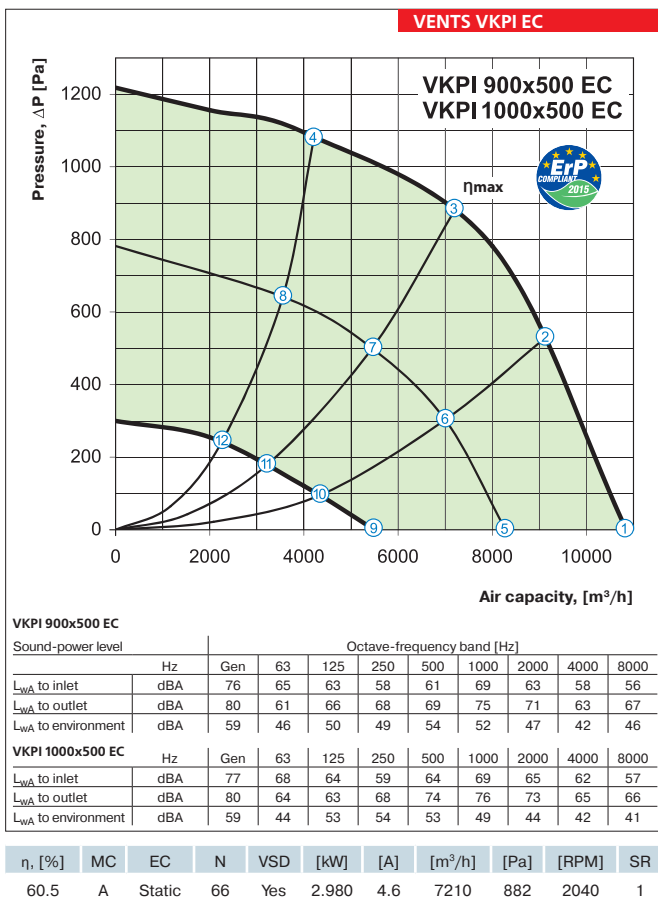

point	P, (W)	I, (A)	n, (min ⁻¹)
1	1988	3.00	2040
2	2596	3.94	2040
3	2980	4.60	2040
4	2638	3.99	2040
5	818	1.28	1550
6	1054	1.63	1545
7	1195	1.83	1550
8	1075	1.66	1570
9	313	0.60	1045
10	362	0.70	1025
11	387	0.72	1010
12	362	0.69	1005

Series
VENTS VKPF



Inline centrifugal fans with the air capacity up to **9540 m³/h** for rectangular ducts

Series
VENTS VKPFI



Inline sound- and heat-insulated centrifugal fans with the air capacity up to **9540 m³/h** for rectangular ducts

■ **Applications**

Supply and exhaust ventilation systems for various premises with a limited mounting space. Designed for connection with 400x200, 500x250, 500x300, 600x300, 600x350, 700x400, 800x500, 900x500, 1000x500 mm rectangular air ducts.

■ **Design**

The fan casing is made of galvanized steel. VKPFI models are sound- and heat-insulated with 50 mm layer of mineral wool.

■ **Motor**

The impeller with forward curved blades made of galvanized steel is powered by 4-, 6- or 8-pole external

rotor asynchronous motor. Such modification ensures high air flow capacity and relatively significant differential pressure. For thermal overheating protection the thermal contacts with leaded outside terminals are incorporated in the motor winding for connection with the external protection devices. The motor is equipped with the ball bearings for long service life. For precise features, safe operation and low noise, each impeller is dynamically balanced while assembly. Motor protection rating IP 44.

■ **Speed control**

Smooth or step speed control with a thyristor or autotransformer speed controller. Several fans may be connected to one speed controller provided that the

total power and operating current do not exceed the rated speed controller parameters.

■ **Mounting**

The fans are designed for inline rectangular air duct mounting and require no special fixing in case of direct connection. In case of connection through the flexible connectors the fan is fixed to a building by means of supports, suspension brackets or fixation brackets. The fans can be mounted in any position with respect to the pointer direction on the casing. Access for the fan maintenance shall be provided. The fan is powered through the external terminals. The casing is provided with the removable access door for maintenance.

Designation key: _____

Series		Motor modification		Flange diameter [WxH]
VENTS VKPF	I – sound- and heat-insulated casing	Number of poles	Phase	
		4	E – single phase D – three phases	
		6		
8				

ErP data	
Overall efficiency	η, [%]
Measurement category	MC
Efficiency category	EC
Efficiency grade	N
Variable speed drive	VSD
Power	[kW]
Current	[A]
Air flow	[m ³ /h]
Static pressure	[Pa]
Speed	[n/min ⁻¹]
Specific ratio	SR

Accessories



page 80 page 80 page 86 page 84 page 42 page 48 page 62 page 63 page 87

Technical data:

	VKPF / VKPFI 4E 400x200	VKPF / VKPFI 4D 400x200	VKPF / VKPFI 4E 500x250	VKPF / VKPFI 4D 500x250 	VKPF / VKPFI 6E 500x250
Voltage [V / 50 Hz]	1~ 230	3~ 400	1~ 230	3~ 400	1~ 230
Power [W]	295	282	535	570	244
Current [A]	1.32	0.60	2.49	0.94	1.22
Max. air capacity [m ³ /h]	1440	1470	1750	1850	1460
RPM [min ⁻¹]	1350	1300	1250	1270	910
Noise level at 3 m [dBA]	50 / 42*	52 / 43*	53 / 44*	54 / 44*	45 / 37*
Transported air temperature [°C]	-25 +40	-25 +45	-20 +40	-20 +40	-20 +50
Protection rating	IP X4	IP X4	IP X4	IP X4	IP X4



* parameter for VKPFI model

Technical data:

	VKPF / VKPFI 6D 500x250	VKPF / VKPFI 4E 500x300	VKPF / VKPFI 4D 500x300	VKPF / VKPFI 6E 500x300	VKPF / VKPFI 6D 500x300
Voltage [V / 50 Hz]	3~ 400	1~ 230	3~ 400	1~ 230	3~ 400
Power [W]	274	710	855	283	303
Current [A]	0.67	3.10	1.70	1.59	0.8
Max. air capacity [m ³ /h]	1490	2350	2350	1550	1620
RPM [min ⁻¹]	930	1230	1300	890	910
Noise level at 3 m [dBA]	45 / 38*	57 / 47*	56 / 47*	47 / 39*	51 / 41*
Transported air temperature [°C]	-20 +60	-25 +70	-20 +50	-20 +70	-20 +60
Protection rating	IP X4	IP X4	IP X4	IP X4	IP X4

* parameter for VKPFI model



Technical data:

	VKPF / VKPFI  4E 600x300	VKPF / VKPFI  4D 600x300	VKPF / VKPFI 6E 600x300	VKPF / VKPFI 6D 600x300	VKPF / VKPFI 4E 600x350
Voltage [V / 50 Hz]	1~ 230	3~ 400	1~ 230	3~ 400	1~ 230
Power [W]	1240	1560	419	397	2840
Current [A]	6.45	2.73	2.05	0.78	13.90
Max. air capacity [m ³ /h]	2950	3740	2260	2320	4260
RPM [min ⁻¹]	1210	1310	870	920	1260
Noise level at 3 m [dBA]	59 / 51*	57 / 50*	50 / 42*	49 / 41*	59 / 51*
Transported air temperature [°C]	-25 +50	-25 +65	-20 +70	-20 +70	-20 +40
Protection rating	IP X4	IP X4	IP X4	IP X4	IP X4

* parameter for VKPFI model



RECTANGULAR INLINE FANS

Technical data:

	VKPF / VKPFI 4D 600x350 	VKPF / VKPFI 6E 600x350	VKPF / VKPFI 6D 600x350	VKPF / VKPFI 4D 700x400 
Voltage [V / 50 Hz]	3~ 400	1~ 230	3~ 400	3~ 400
Power [W]	2460	720	743	3630
Current [A]	3.93	3.6	1.47	6.00
Max. air capacity [m ³ /h]	5020	2755	3310	6450
RPM [min ⁻¹]	1300	820	940	1320
Noise level at 3 m [dBA]	60 / 52*	51 / 43*	55 / 46*	65 / 56*
Transported air temperature [°C]	-20 +40	-20 +60	-20 +70	-25 +40
Protection rating	IP X4	IP X4	IP X4	IP X4

* parameter for VKPFI model

Technical data:

	VKPF / VKPFI 6D 700x400	VKPF / VKPFI 4D 800x500 	VKPF / VKPFI 6D 800x500 	VKPF / VKPFI 8D 800x500
Voltage [V / 50 Hz]	3~ 400	3~ 400	3~ 400	3~ 400
Power [W]	1150	5850	2790	1377
Current [A]	2.3	9.35	5.18	3.40
Max. air capacity [m ³ /h]	4050	8120	7610	5620
RPM [min ⁻¹]	890	1140	830	710
Noise level at 3 m [dBA]	58 / 49*	67 / 61*	59 / 53*	58 / 49
Transported air temperature [°C]	-20 +70	-25 +40	-20 +50	-20 +40
Protection rating	IP X4	IP X4	IP X4	IP X4

* parameter for VKPFI model

Technical data:

	VKPF / VKPFI 6D 900x500	VKPF / VKPFI 8D 900x500	VKPF / VKPFI 6D 1000x500	VKPF / VKPFI 8D 1000x500
Voltage [V / 50 Hz]	3~ 400	3~ 400	3~ 400	3~ 400
Power [W]	3870	2000	3870	2000
Current [A]	7.0	4.1	7.0	4.1
Max. air capacity [m ³ /h]	9540	7175	9540	7175
RPM [min ⁻¹]	930	680	930	680
Noise level at 3 m [dBA]	61 / 55*	59 / 50*	61 / 55*	59 / 51*
Transported air temperature [°C]	-20 +55	-20 +40	-20 +55	-20 +40
Protection rating	IP X4	IP X4	IP X4	IP X4

* parameter for VKPFI model

Fan overall dimensions:

Type	Dimensions [mm]								Weight [kg]
	B	B1	B2	H	H1	H2	H3	L	
VKPF 4E 400x200	400	420	440	200	220	240	255	500	17.5
VKPF 4D 400x200	400	420	440	200	220	240	255	500	17.5
VKPF 4E 500x250	500	520	540	250	270	290	335	640	24
VKPF 4D 500x250	500	520	540	250	270	290	335	640	24
VKPF 6E 500x250	500	520	540	250	270	290	335	640	24
VKPF 6D 500x250	500	520	540	250	270	290	335	640	24
VKPF 4E 500x300	500	520	540	300	320	340	365	680	33
VKPF 4D 500x300	500	520	540	300	320	340	365	680	33
VKPF 6E 500x300	500	520	540	300	320	340	365	680	33
VKPF 6D 500x300	500	520	540	300	320	340	365	680	33
VKPF 4E 600x300	600	620	640	300	320	340	375	680	35
VKPF 4D 600x300	600	620	640	300	320	340	375	680	35
VKPF 6E 600x300	600	620	640	300	320	340	375	680	35
VKPF 6D 600x300	600	620	640	300	320	340	375	680	35
VKPF 4E 600x350	600	620	640	350	370	390	425	735	49.5
VKPF 4D 600x350	600	620	640	350	370	390	425	735	49.5
VKPF 6E 600x350	600	620	640	350	370	390	425	735	49.5
VKPF 6D 600x350	600	620	640	350	370	390	425	735	49.5
VKPF 4D 700x400	700	720	740	400	420	440	480	780	60
VKPF 6D 700x400	700	720	740	400	420	440	480	780	56
VKPF 4D 800x500	800	820	840	500	520	540	580	820	74
VKPF 6D 800x500	800	820	840	500	520	540	580	820	70
VKPF 8D 800x500	800	820	840	500	520	540	580	820	70
VKPF 6D 900x500	900	920	940	500	520	540	580	954	90
VKPF 8D 900x500	900	920	940	500	520	540	580	954	90
VKPF 6D 1000x500	1000	1020	1040	500	520	540	580	954	95
VKPF 8D 1000x500	1000	1020	1040	500	520	540	580	954	95

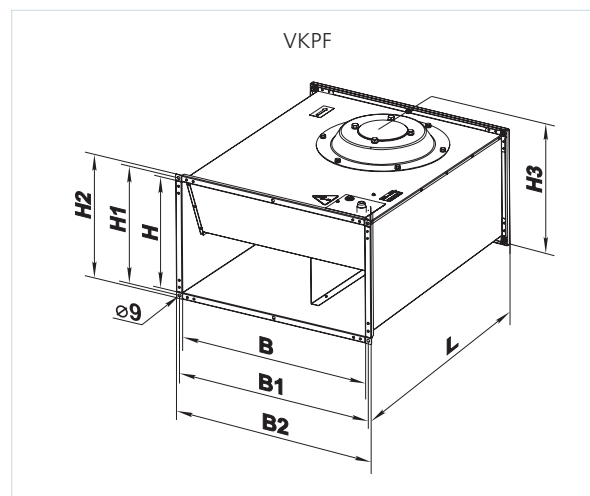

RECTANGULAR INLINE FANS

Fan overall dimensions:

Type	Dimensions [mm]									Weight [kg]
	B	B1	B2	B3	H	H1	H2	H3	L	
VKPF1 4E 400x200	400	420	440	470	200	220	240	360	500	29
VKPF1 4D 400x200	400	420	440	470	200	220	240	360	500	29
VKPF1 4E 500x250	500	520	540	570	250	270	290	410	640	40.5
VKPF1 4D 500x250	500	520	540	570	250	270	290	410	640	40.5
VKPF1 6E 500x250	500	520	540	570	250	270	290	410	640	40.5
VKPF1 6D 500x250	500	520	540	570	250	270	290	410	640	40.5
VKPF1 4E 500x300	500	520	540	570	300	320	340	460	680	52.5
VKPF1 4D 500x300	500	520	540	570	300	320	340	460	680	52.5
VKPF1 6E 500x300	500	520	540	570	300	320	340	460	680	52.5
VKPF1 6D 500x300	500	520	540	570	300	320	340	460	680	52.5
VKPF1 4E 600x300	600	620	640	670	300	320	340	480	680	56
VKPF1 4D 600x300	600	620	640	670	300	320	340	480	680	56
VKPF1 6E 600x300	600	620	640	670	300	320	340	480	680	56
VKPF1 6D 600x300	600	620	640	670	300	320	340	480	680	56
VKPF1 4E 600x350	600	620	640	670	350	370	390	530	735	72
VKPF1 4D 600x350	600	620	640	670	350	370	390	530	735	72
VKPF1 6E 600x350	600	620	640	670	350	370	390	530	735	72
VKPF1 6D 600x350	600	620	640	670	350	370	390	530	735	72
VKPF1 4D 700x400	700	720	-	800	400	420	-	620	880	103
VKPF1 6D 700x400	700	720	-	800	400	420	-	620	880	99
VKPF1 6D 800x500	800	820	-	900	500	520	-	720	935	120
VKPF1 4D 800x500	800	820	-	900	500	520	-	720	935	127
VKPF1 8D 800x500	800	820	-	900	500	520	-	720	935	120
VKPF1 6D 900x500	900	920	-	1000	500	520	-	720	1000	142
VKPF1 8D 900x500	900	920	-	1000	500	520	-	720	1000	142
VKPF1 6D 1000x500	1000	1020	-	1100	500	520	-	720	1000	150
VKPF1 8D 1000x500	1000	1020	-	1100	500	520	-	720	1000	150

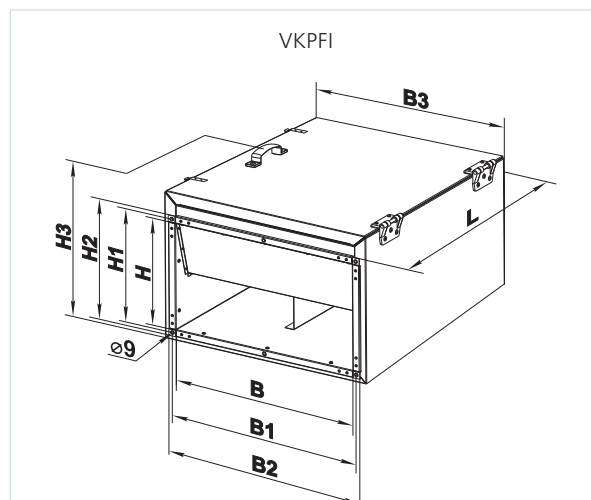

VENTS VKPF / VKPFI

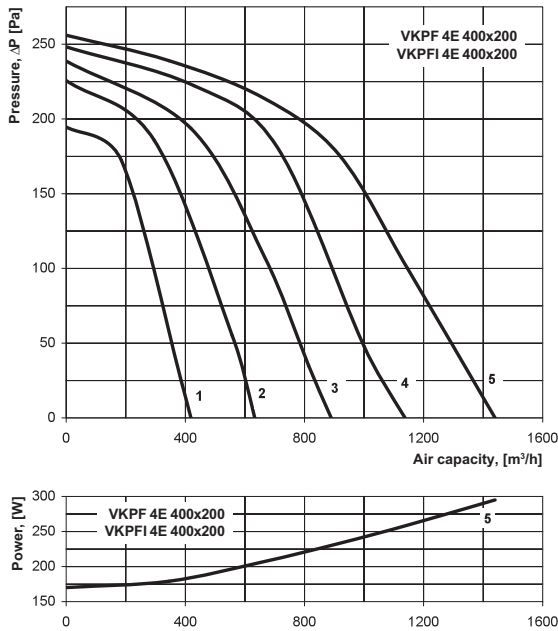

VKPF 4E 400x200

Sound-power level	Hz	Octave-frequency band [Hz]								
		Gen	63	125	250	500	1000	2000	4000	8000
L _{WA} to inlet	dBA	69	58	68	63	59	56	53	53	45
L _{WA} to outlet	dBA	70	53	63	67	62	65	63	58	55
L _{WA} to environment	dBA	59	34	46	57	52	49	43	40	36

VKPFI 4E 400x200

Sound-power level	Hz	Octave-frequency band [Hz]								
		Gen	63	125	250	500	1000	2000	4000	8000
L _{WA} to inlet	dBA	66	50	60	58	54	50	49	46	39
L _{WA} to outlet	dBA	67	48	60	62	58	60	57	54	49
L _{WA} to environment	dBA	43	24	35	45	41	36	34	29	22

VENTS VKPF / VKPFI

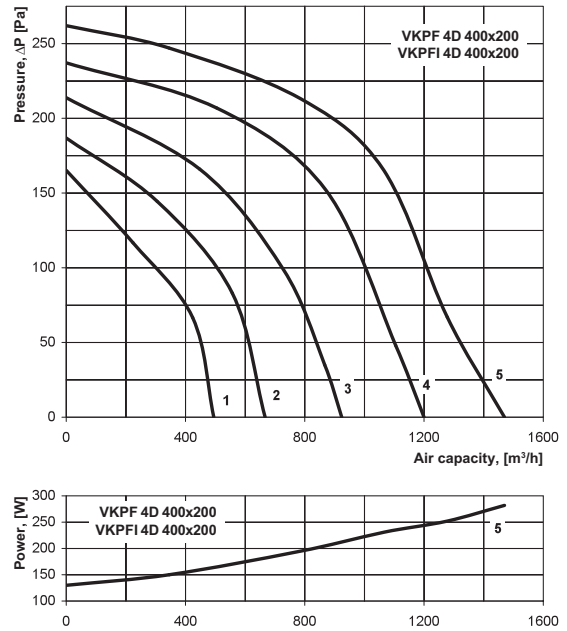

VKPF 4D 400x200

Sound-power level	Hz	Octave-frequency band [Hz]								
		Gen	63	125	250	500	1000	2000	4000	8000
L _{WA} to inlet	dBA	72	56	69	65	57	58	57	53	48
L _{WA} to outlet	dBA	74	54	65	66	61	63	60	61	55
L _{WA} to environment	dBA	61	34	44	56	52	50	44	40	33

VKPFI 4D 400x200

Sound-power level	Hz	Octave-frequency band [Hz]								
		Gen	63	125	250	500	1000	2000	4000	8000
L _{WA} to inlet	dBA	65	53	62	60	54	52	50	46	41
L _{WA} to outlet	dBA	66	48	59	62	58	58	58	53	47
L _{WA} to environment	dBA	47	24	36	45	38	36	30	29	22

VENTS VKPF / VKPFI

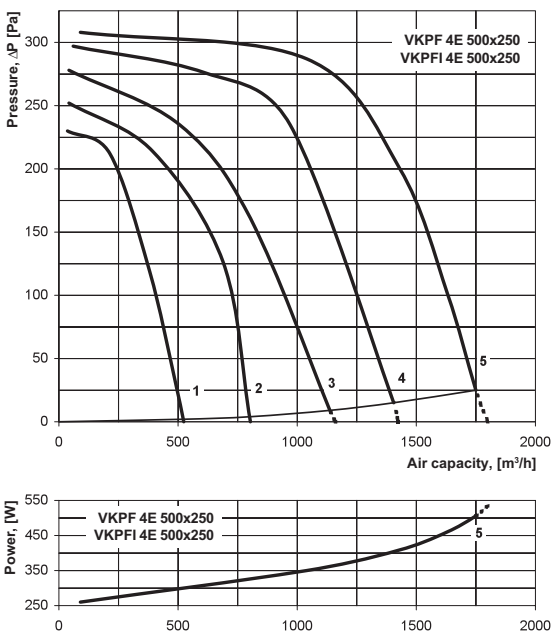

VKPF 4E 500x250

Sound-power level	Hz	Octave-frequency band [Hz]								
		Gen	63	125	250	500	1000	2000	4000	8000
L _{WA} to inlet	dBA	72	58	67	62	57	62	64	62	60
L _{WA} to outlet	dBA	77	57	63	62	66	72	69	68	63
L _{WA} to environment	dBA	62	41	49	54	53	56	52	51	53

VKPFI 4E 500x250

Sound-power level	Hz	Octave-frequency band [Hz]								
		Gen	63	125	250	500	1000	2000	4000	8000
L _{WA} to inlet	dBA	68	57	62	58	54	57	58	59	53
L _{WA} to outlet	dBA	72	50	60	61	60	66	66	61	62
L _{WA} to environment	dBA	51	29	36	39	43	44	38	37	43

VENTS VKPF / VKPFI

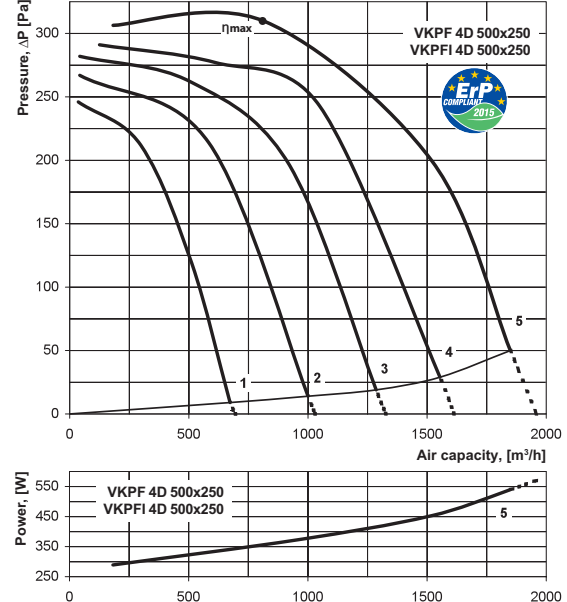

η, [%]	MC	EC	N	VSD	[kW]	[A]	[m³/h]	[Pa]	[RPM]	SR
34.3	A	Static	44.9	No	0.210	0.6	820	310	1420	1

VKPF 4D 500x250

Sound-power level	Hz	Octave-frequency band [Hz]								
		Gen	63	125	250	500	1000	2000	4000	8000
L _{WA} to inlet	dBA	74	60	67	64	61	64	62	60	58
L _{WA} to outlet	dBA	76	57	65	65	67	69	69	68	63
L _{WA} to environment	dBA	61	41	48	53	53	56	52	50	53

VKPFI 4D 500x250

Sound-power level	Hz	Octave-frequency band [Hz]								
		Gen	63	125	250	500	1000	2000	4000	8000
L _{WA} to inlet	dBA	67	55	61	57	52	61	58	57	54
L _{WA} to outlet	dBA	71	49	58	60	62	67	66	61	60
L _{WA} to environment	dBA	50	27	38	41	44	45	42	40	43

RECTANGULAR INLINE FANS

VENTS VKPF / VKPFI

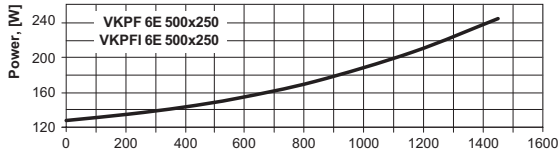
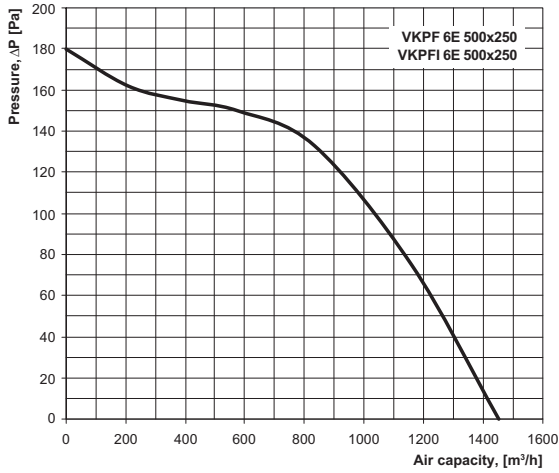

VKPF 6E 500x250

Sound-power level	Hz	Gen	Octave-frequency band [Hz]							
			63	125	250	500	1000	2000	4000	8000
L _{WA} to inlet	dBA	58	45	53	48	49	48	47	43	41
L _{WA} to outlet	dBA	55	45	50	49	55	52	50	51	39
L _{WA} to environment	dBA	43	25	34	41	36	38	33	24	24

VKPFI 6E 500x250

Sound-power level	Hz	Gen	Octave-frequency band [Hz]							
			63	125	250	500	1000	2000	4000	8000
L _{WA} to inlet	dBA	55	41	51	44	47	45	44	39	39
L _{WA} to outlet	dBA	51	42	47	47	52	48	47	47	36
L _{WA} to environment	dBA	35	20	28	34	28	33	27	21	20

VENTS VKPF / VKPFI

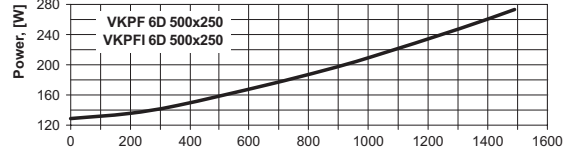
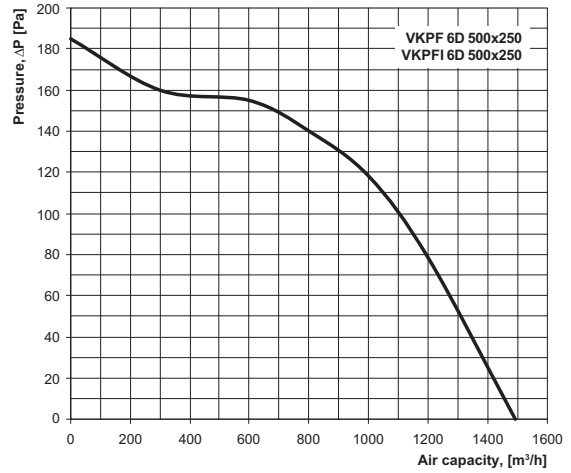

VKPF 6D 500x250

Sound-power level	Hz	Gen	Octave-frequency band [Hz]							
			63	125	250	500	1000	2000	4000	8000
L _{WA} to inlet	dBA	59	48	55	52	50	51	49	47	42
L _{WA} to outlet	dBA	58	47	54	52	57	56	53	53	43
L _{WA} to environment	dBA	45	29	36	45	38	42	35	28	26

VKPFI 6D 500x250

Sound-power level	Hz	Gen	Octave-frequency band [Hz]							
			63	125	250	500	1000	2000	4000	8000
L _{WA} to inlet	dBA	55	46	51	50	47	48	45	45	39
L _{WA} to outlet	dBA	55	44	52	49	53	53	49	50	39
L _{WA} to environment	dBA	40	23	29	37	33	36	32	24	21

VENTS VKPF / VKPFI

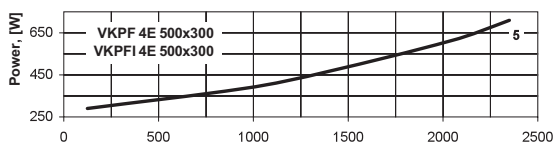
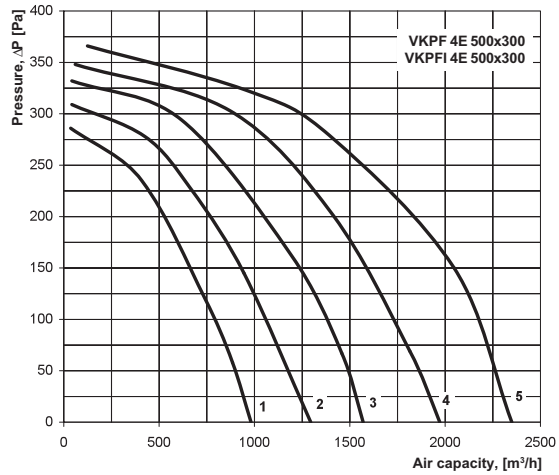

VKPF 4E 500x300

Sound-power level	Hz	Gen	Octave-frequency band [Hz]							
			63	125	250	500	1000	2000	4000	8000
L _{WA} to inlet	dBA	74	64	69	65	63	66	67	65	60
L _{WA} to outlet	dBA	79	62	69	66	72	73	72	71	64
L _{WA} to environment	dBA	64	46	53	59	54	58	56	49	50

VKPFI 4E 500x300

Sound-power level	Hz	Gen	Octave-frequency band [Hz]							
			63	125	250	500	1000	2000	4000	8000
L _{WA} to inlet	dBA	69	59	65	59	58	64	63	60	56
L _{WA} to outlet	dBA	74	57	62	63	65	69	68	65	61
L _{WA} to environment	dBA	53	34	43	48	43	46	42	37	38

VENTS VKPF / VKPFI

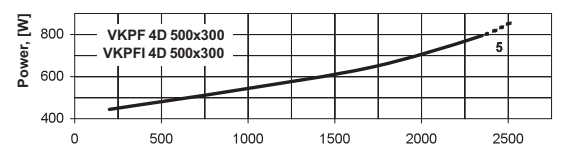
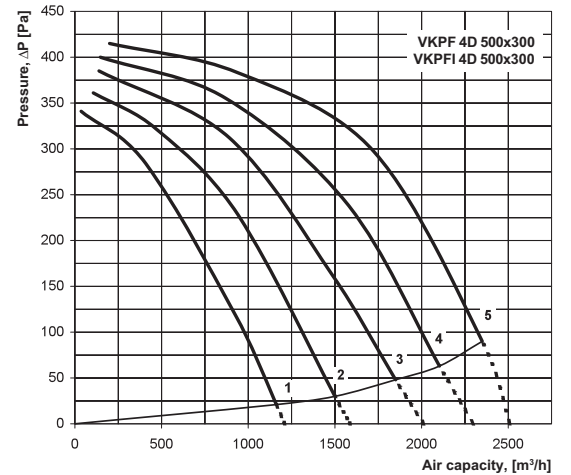

VKPF 4D 500x300

Sound-power level	Hz	Gen	Octave-frequency band [Hz]							
			63	125	250	500	1000	2000	4000	8000
L _{WA} to inlet	dBA	77	67	69	62	63	68	68	68	63
L _{WA} to outlet	dBA	79	61	68	69	71	75	74	73	68
L _{WA} to environment	dBA	65	46	55	58	56	60	54	48	47

VKPFI 4D 500x300

Sound-power level	Hz	Gen	Octave-frequency band [Hz]							
			63	125	250	500	1000	2000	4000	8000
L _{WA} to inlet	dBA	71	62	64	59	60	62	63	63	56
L _{WA} to outlet	dBA	72	58	62	63	65	71	66	67	63
L _{WA} to environment	dBA	52	33	42	48	45	46	42	36	36

VENTS VKPF / VKPFI

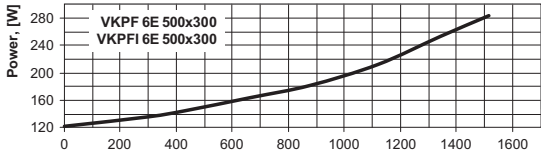
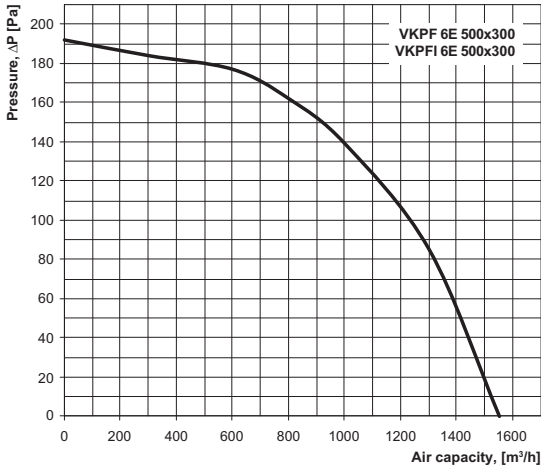

VKPF 6E 500x300

Sound-power level	Hz	Octave-frequency band [Hz]								
		Gen	63	125	250	500	1000	2000	4000	8000
L _{WA} to inlet	dBA	65	53	58	56	50	57	55	51	47
L _{WA} to outlet	dBA	68	53	56	53	60	64	58	60	51
L _{WA} to environment	dBA	51	45	44	50	42	45	43	34	31

VKPFI 6E 500x300

Sound-power level	Hz	Octave-frequency band [Hz]								
		Gen	63	125	250	500	1000	2000	4000	8000
L _{WA} to inlet	dBA	61	51	55	53	46	55	51	49	44
L _{WA} to outlet	dBA	66	50	52	50	56	61	56	57	47
L _{WA} to environment	dBA	44	37	39	44	39	41	36	26	26

VENTS VKPF / VKPFI

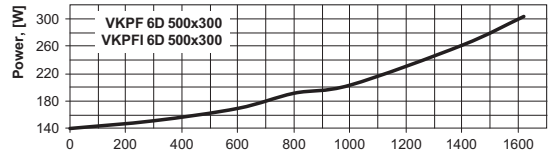
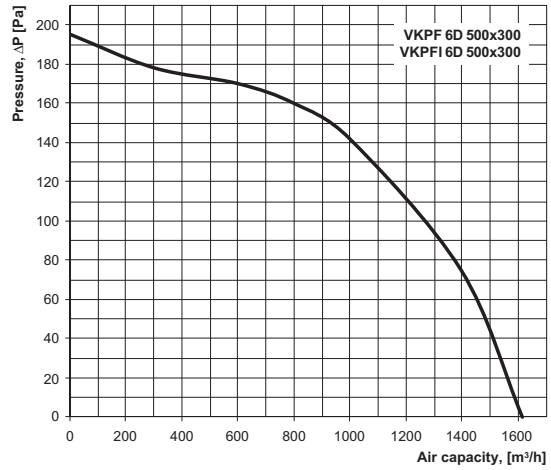

VKPF 6D 500x300

Sound-power level	Hz	Octave-frequency band [Hz]								
		Gen	63	125	250	500	1000	2000	4000	8000
L _{WA} to inlet	dBA	62	56	59	52	53	57	51	50	44
L _{WA} to outlet	dBA	66	51	57	55	62	59	54	55	48
L _{WA} to environment	dBA	52	30	45	47	42	43	40	33	31

VKPFI 6D 500x300

Sound-power level	Hz	Octave-frequency band [Hz]								
		Gen	63	125	250	500	1000	2000	4000	8000
L _{WA} to inlet	dBA	59	52	57	48	51	54	49	47	41
L _{WA} to outlet	dBA	63	47	54	53	59	55	51	51	45
L _{WA} to environment	dBA	46	27	41	40	34	38	32	28	25

VENTS VKPF / VKPFI

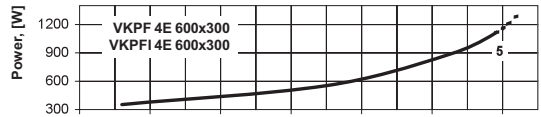
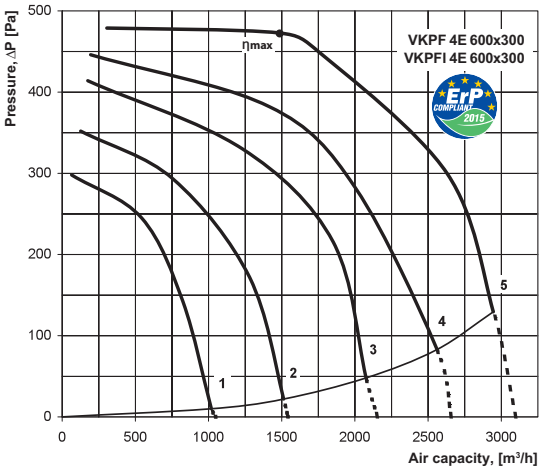

η, [%]	MC	EC	N	VSD	[kW]	[A]	[m³/h]	[Pa]	[RPM]	SR
35.8	A	Static	43.7	No	0.555	2.33	1482	473	1425	1

VKPF 4E 600x300

Sound-power level	Hz	Octave-frequency band [Hz]								
		Gen	63	125	250	500	1000	2000	4000	8000
L _{WA} to inlet	dBA	83	66	77	69	66	71	70	71	67
L _{WA} to outlet	dBA	85	62	77	71	74	79	76	73	67
L _{WA} to environment	dBA	69	42	65	66	61	61	56	53	47

VKPFI 4E 600x300

Sound-power level	Hz	Octave-frequency band [Hz]								
		Gen	63	125	250	500	1000	2000	4000	8000
L _{WA} to inlet	dBA	78	61	72	63	62	68	68	65	66
L _{WA} to outlet	dBA	80	55	74	65	72	74	70	68	66
L _{WA} to environment	dBA	58	30	53	54	49	48	43	39	37

VENTS VKPF / VKPFI

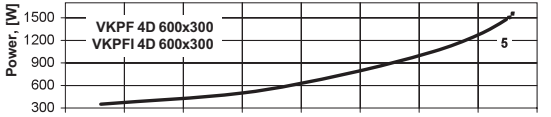
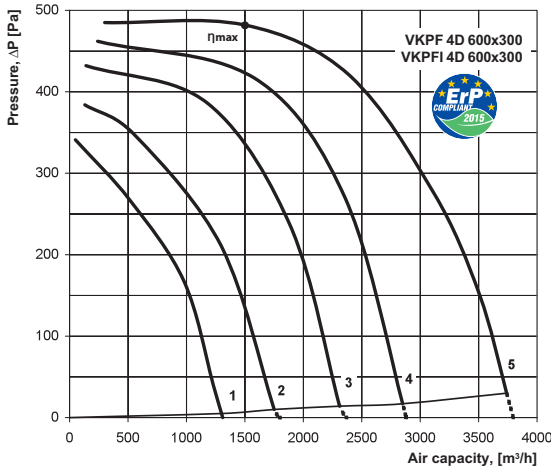

η, [%]	MC	EC	N	VSD	[kW]	[A]	[m³/h]	[Pa]	[RPM]	SR
40.6	A	Static	48.8	No	0.510	1.9	1508	485	1440	1

VKPF 4D 600x300

Sound-power level	Hz	Octave-frequency band [Hz]								
		Gen	63	125	250	500	1000	2000	4000	8000
L _{WA} to inlet	dBA	82	66	77	67	67	70	72	68	69
L _{WA} to outlet	dBA	82	62	77	71	76	79	75	76	67
L _{WA} to environment	dBA	71	43	63	62	64	62	55	49	51

VKPFI 4D 600x300

Sound-power level	Hz	Octave-frequency band [Hz]								
		Gen	63	125	250	500	1000	2000	4000	8000
L _{WA} to inlet	dBA	75	65	72	62	62	67	66	62	64
L _{WA} to outlet	dBA	79	57	72	66	70	72	70	67	65
L _{WA} to environment	dBA	56	30	52	52	49	51	42	37	35

RECTANGULAR INLINE FANS

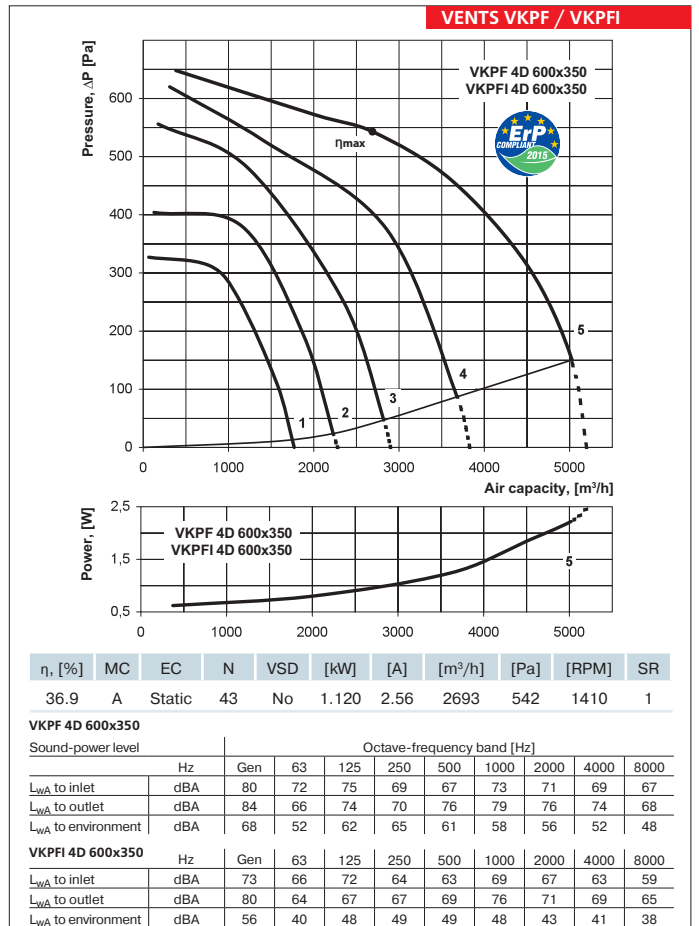
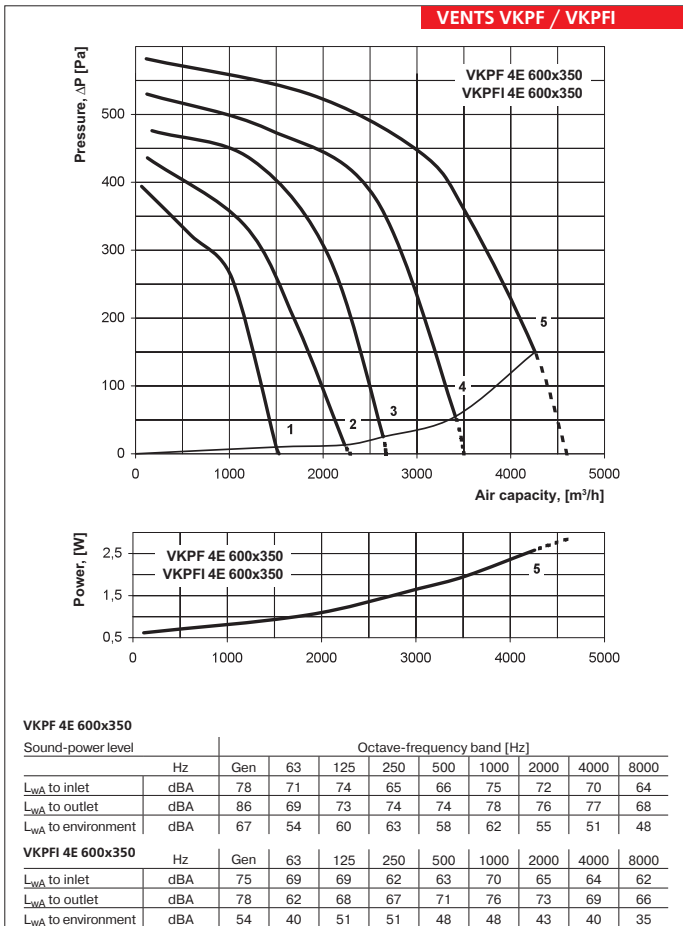
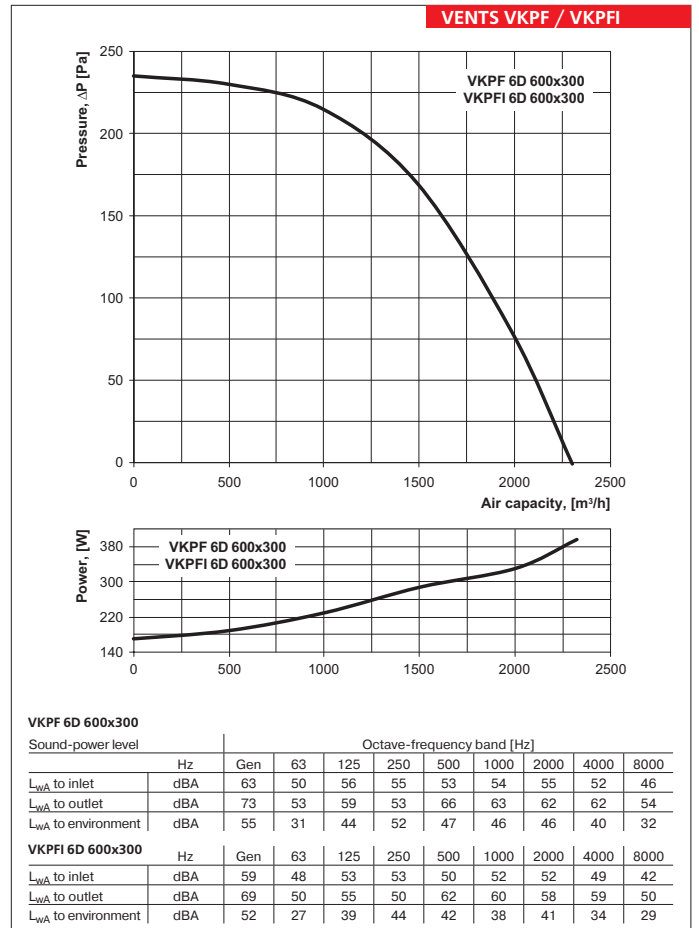
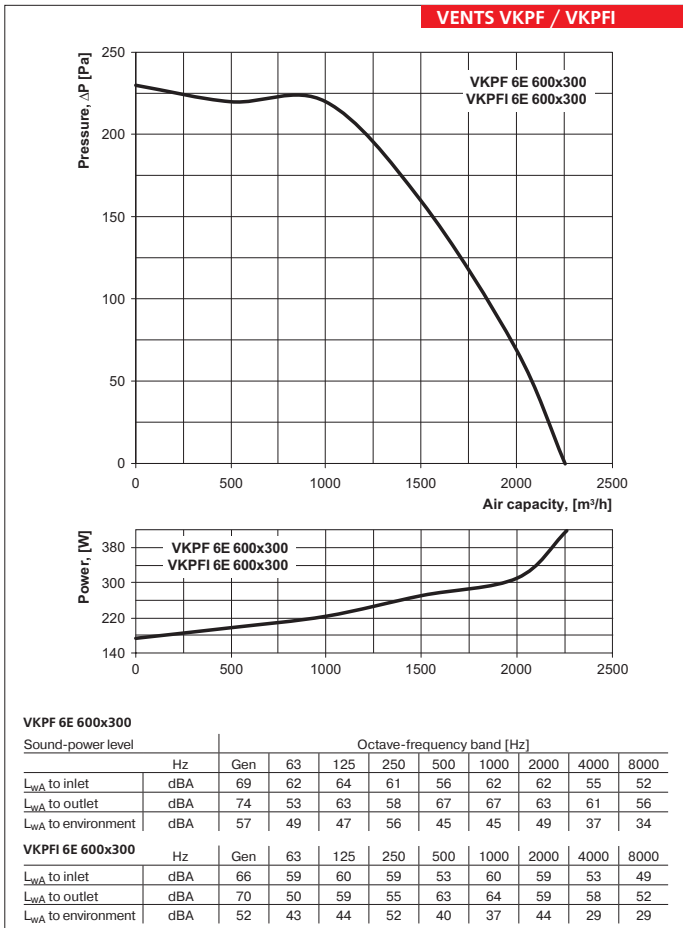

η , [%]	MC	EC	N	VSD	[kW]	[A]	[m³/h]	[Pa]	[RPM]	SR
36.9	A	Static	43	No	1.120	2.56	2693	542	1410	1

VENTS VKPF / VKPFI

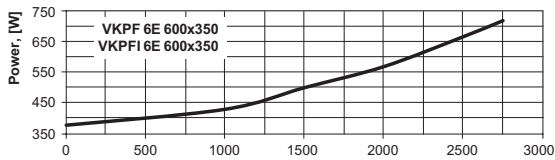
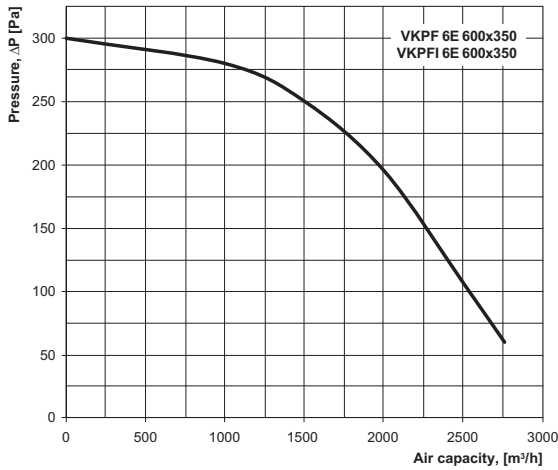

VKPF 6E 600x350

Sound-power level	Hz	Octave-frequency band [Hz]								
		Gen	63	125	250	500	1000	2000	4000	8000
L _{WA} to inlet	dBA	68	54	59	56	57	59	57	56	50
L _{WA} to outlet	dBA	72	52	59	59	67	64	60	64	53
L _{WA} to environment	dBA	55	47	47	52	46	49	48	40	34

VKPFI 6E 600x350

Sound-power level	Hz	Octave-frequency band [Hz]								
		Gen	63	125	250	500	1000	2000	4000	8000
L _{WA} to inlet	dBA	65	52	56	53	53	57	54	54	47
L _{WA} to outlet	dBA	68	49	55	56	63	61	56	61	49
L _{WA} to environment	dBA	50	39	42	46	43	45	43	32	29

VENTS VKPF / VKPFI

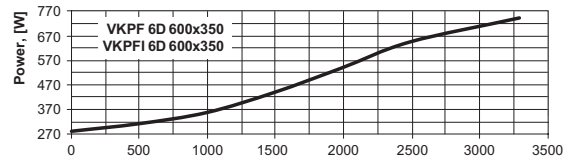
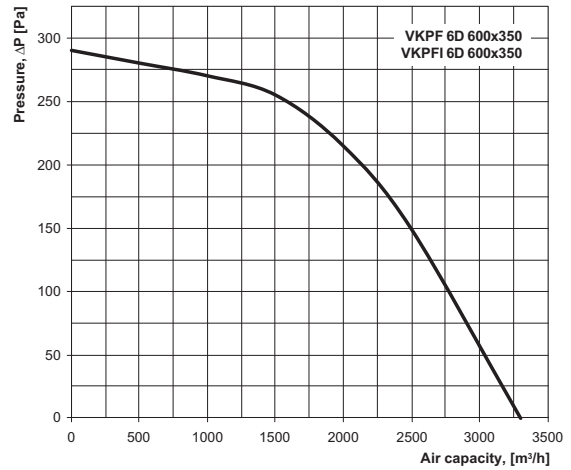

VKPF 6D 600x350

Sound-power level	Hz	Octave-frequency band [Hz]								
		Gen	63	125	250	500	1000	2000	4000	8000
L _{WA} to inlet	dBA	66	59	65	55	56	62	60	56	53
L _{WA} to outlet	dBA	72	57	60	60	64	67	63	61	55
L _{WA} to environment	dBA	59	36	50	55	48	47	44	41	37

VKPFI 6D 600x350

Sound-power level	Hz	Octave-frequency band [Hz]								
		Gen	63	125	250	500	1000	2000	4000	8000
L _{WA} to inlet	dBA	63	55	63	52	54	59	58	53	50
L _{WA} to outlet	dBA	69	53	57	56	61	63	60	57	52
L _{WA} to environment	dBA	53	33	46	50	40	42	36	36	31

VENTS VKPF / VKPFI

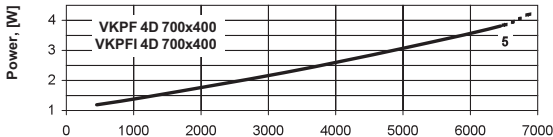
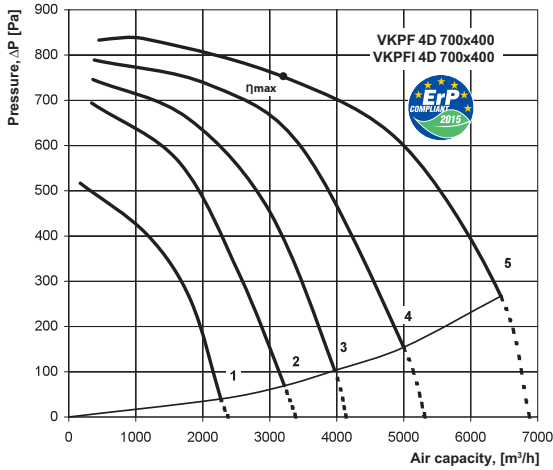

η _i [%]	MC	EC	N	VSD	[kW]	[A]	[m³/h]	[Pa]	[RPM]	SR
32.4	A	Static	41	No	1.890	4.34	3240	751	1430	1

VKPF 4D 700x400

Sound-power level	Hz	Octave-frequency band [Hz]								
		Gen	63	125	250	500	1000	2000	4000	8000
L _{WA} to inlet	dBA	82	80	77	70	71	75	73	71	68
L _{WA} to outlet	dBA	86	74	77	75	78	83	81	77	71
L _{WA} to environment	dBA	71	55	64	69	67	70	63	62	59

VKPFI 4D 700x400

Sound-power level	Hz	Octave-frequency band [Hz]								
		Gen	63	125	250	500	1000	2000	4000	8000
L _{WA} to inlet	dBA	77	75	70	64	62	73	71	66	64
L _{WA} to outlet	dBA	79	68	70	70	72	76	72	74	67
L _{WA} to environment	dBA	61	41	54	57	53	56	52	53	47

VENTS VKPF / VKPFI

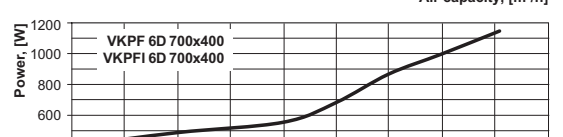
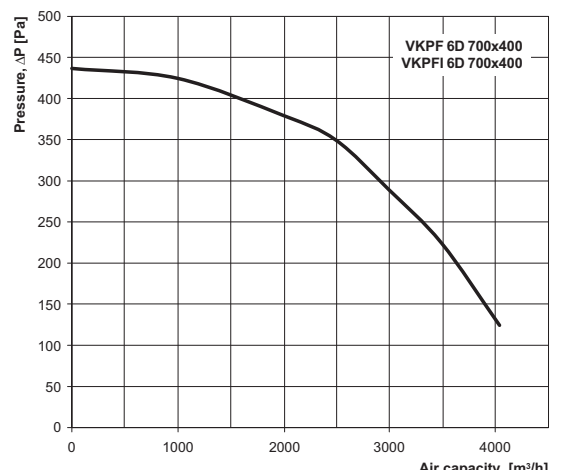

VKPF 6D 700x400

Sound-power level	Hz	Octave-frequency band [Hz]								
		Gen	63	125	250	500	1000	2000	4000	8000
L _{WA} to inlet	dBA	70	65	61	59	59	64	61	59	54
L _{WA} to outlet	dBA	74	62	62	61	67	68	63	68	58
L _{WA} to environment	dBA	64	39	51	56	55	51	48	42	39

VKPFI 6D 700x400

Sound-power level	Hz	Octave-frequency band [Hz]								
		Gen	63	125	250	500	1000	2000	4000	8000
L _{WA} to inlet	dBA	68	62	59	56	56	61	59	56	52
L _{WA} to outlet	dBA	71	58	59	57	64	64	60	64	55
L _{WA} to environment	dBA	56	34	43	51	49	46	40	37	31

RECTANGULAR INLINE FANS

VENTS VKPF / VKPFI

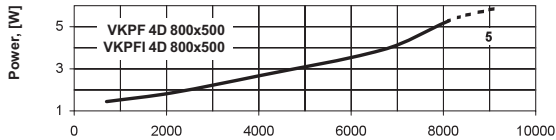
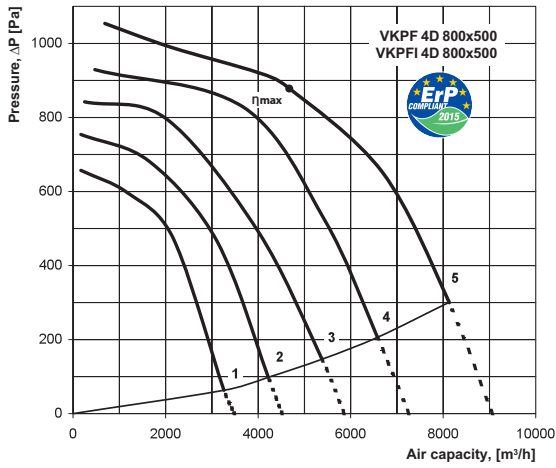

η, [%]	MC	EC	N	VSD	[kW]	[A]	[m³/h]	[Pa]	[RPM]	SR
42.3	A	Static	45.9	No	2.743	4.9	4648	881	1330	1

VKPF 4D 800x500

Sound-power level	Hz	Gen	Octave-frequency band [Hz]							
			63	125	250	500	1000	2000	4000	8000
L _{WA} to inlet	dBA	82	71	74	75	70	75	75	70	67
L _{WA} to outlet	dBA	90	72	77	76	82	86	85	80	78
L _{WA} to environment	dBA	73	61	68	67	65	70	66	61	60

VKPFI 4D 800x500

Sound-power level	Hz	Gen	Octave-frequency band [Hz]							
			63	125	250	500	1000	2000	4000	8000
L _{WA} to inlet	dBA	79	68	68	70	65	71	71	66	62
L _{WA} to outlet	dBA	84	65	72	73	77	81	80	75	71
L _{WA} to environment	dBA	64	49	56	55	53	59	50	48	48

VENTS VKPF / VKPFI

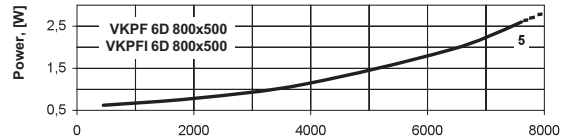
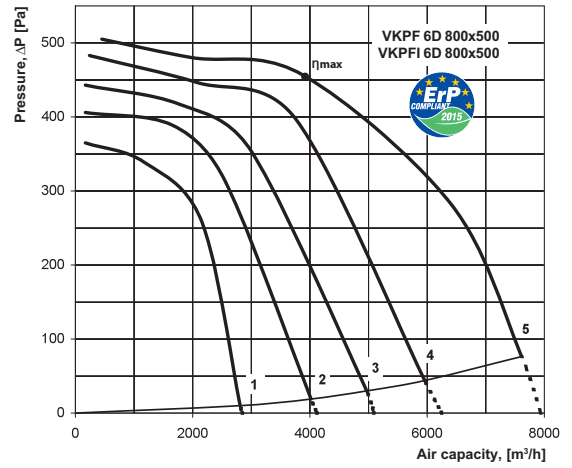

η, [%]	MC	EC	N	VSD	[kW]	[A]	[m³/h]	[Pa]	[RPM]	SR
43.6	A	Static	49.5	No	1.150	2.9	3870	457	940	1

VKPF 6D 800x500

Sound-power level	Hz	Gen	Octave-frequency band [Hz]							
			63	125	250	500	1000	2000	4000	8000
L _{WA} to inlet	dBA	77	64	66	66	70	71	70	66	62
L _{WA} to outlet	dBA	82	64	66	69	76	74	73	73	64
L _{WA} to environment	dBA	64	51	59	58	61	60	55	50	49

VKPFI 6D 800x500

Sound-power level	Hz	Gen	Octave-frequency band [Hz]							
			63	125	250	500	1000	2000	4000	8000
L _{WA} to inlet	dBA	70	61	60	60	64	67	66	63	58
L _{WA} to outlet	dBA	79	58	63	64	72	73	70	69	62
L _{WA} to environment	dBA	54	37	45	45	50	48	41	37	39

VENTS VKPF / VKPFI

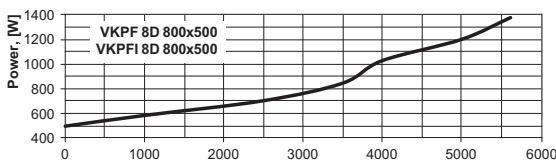
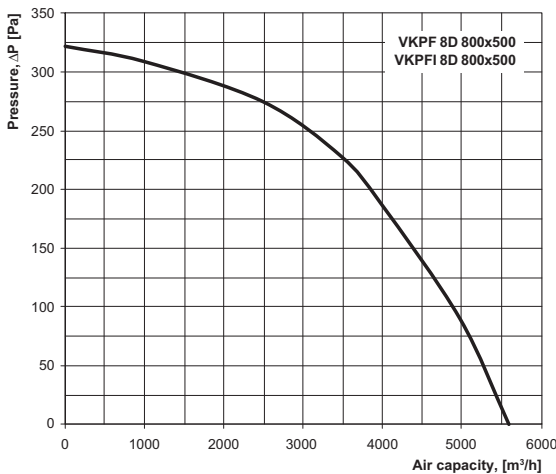

VKPF 8D 800x500

Sound-power level	Hz	Gen	Octave-frequency band [Hz]							
			63	125	250	500	1000	2000	4000	8000
L _{WA} to inlet	dBA	66	55	57	56	54	61	58	54	47
L _{WA} to outlet	dBA	71	54	56	59	68	65	63	60	53
L _{WA} to environment	dBA	64	47	46	55	49	51	52	53	58

VKPFI 8D 800x500

Sound-power level	Hz	Gen	Octave-frequency band [Hz]							
			63	125	250	500	1000	2000	4000	8000
L _{WA} to inlet	dBA	63	52	54	54	51	59	56	51	45
L _{WA} to outlet	dBA	67	51	52	56	64	62	60	56	50
L _{WA} to environment	dBA	59	41	41	47	44	43	44	48	50

VENTS VKPF / VKPFI

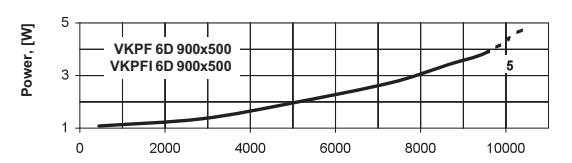
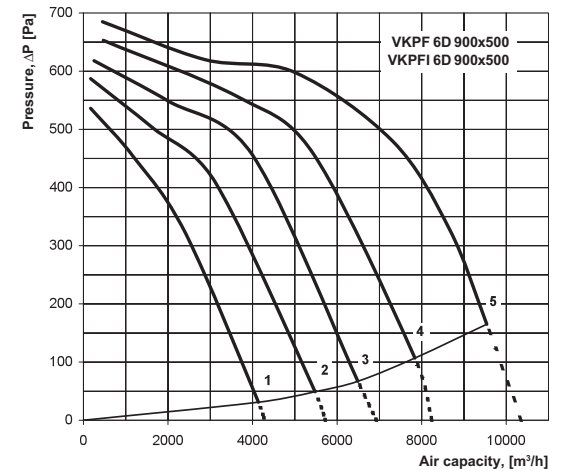

VKPF 6D 900x500

Sound-power level	Hz	Gen	Octave-frequency band [Hz]							
			63	125	250	500	1000	2000	4000	8000
L _{WA} to inlet	dBA	78	70	68	63	72	69	71	68	64
L _{WA} to outlet	dBA	83	71	70	70	80	78	79	74	68
L _{WA} to environment	dBA	65	56	64	60	63	58	56	52	51

VKPFI 6D 900x500

Sound-power level	Hz	Gen	Octave-frequency band [Hz]							
			63	125	250	500	1000	2000	4000	8000
L _{WA} to inlet	dBA	73	65	64	57	66	68	68	62	57
L _{WA} to outlet	dBA	80	62	66	66	71	74	72	69	65
L _{WA} to environment	dBA	55	45	51	46	52	48	47	41	43

VENTS VKPF / VKPFI

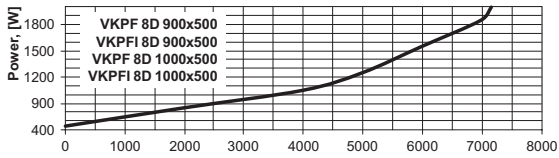
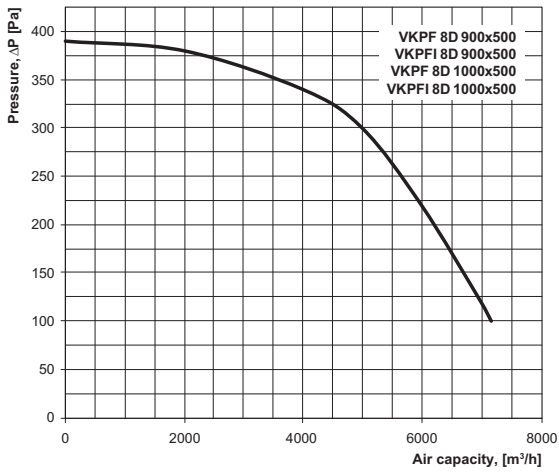

VKPF 8D 900x500

VKPF 8D 1000x500

Sound-power level	Hz	Gen	Octave-frequency band [Hz]							
			63	125	250	500	1000	2000	4000	8000
L_{WA} to inlet	dBA	72	59	61	58	62	63	61	58	54
L_{WA} to outlet	dBA	74	58	58	64	72	67	66	66	58
L_{WA} to environment	dBA	64	48	51	59	55	53	52	49	43

VKPF 8D 900x500

Sound-power level	Hz	Gen	Octave-frequency band [Hz]							
			63	125	250	500	1000	2000	4000	8000
L_{WA} to inlet	dBA	69	57	59	55	60	60	58	56	51
L_{WA} to outlet	dBA	70	55	55	60	69	64	62	63	54
L_{WA} to environment	dBA	59	40	43	54	47	47	47	41	38

VENTS VKPF / VKPFI

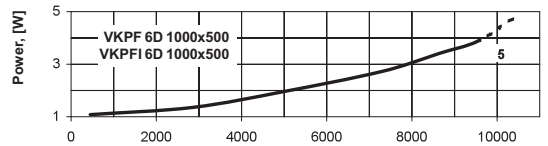
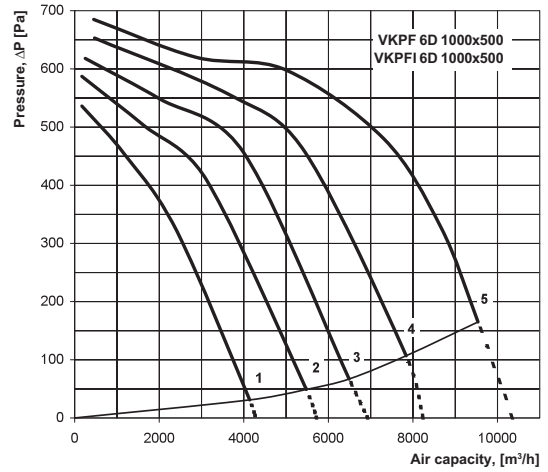

VKPF 6D 1000x500

Sound-power level	Hz	Gen	Octave-frequency band [Hz]							
			63	125	250	500	1000	2000	4000	8000
L_{WA} to inlet	dBA	80	73	68	64	74	71	72	69	66
L_{WA} to outlet	dBA	86	70	71	71	78	78	78	75	71
L_{WA} to environment	dBA	69	59	61	59	65	61	58	53	53

VKPF 6D 1000x500

Sound-power level	Hz	Gen	Octave-frequency band [Hz]							
			63	125	250	500	1000	2000	4000	8000
L_{WA} to inlet	dBA	76	68	62	58	66	66	67	64	60
L_{WA} to outlet	dBA	80	64	64	67	74	75	73	67	67
L_{WA} to environment	dBA	59	46	51	50	53	48	46	42	40

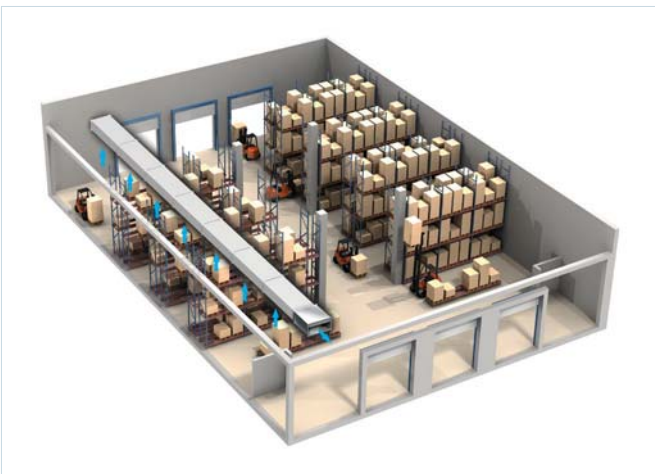

VKPF fan warehouse ventilation example



VKPF 6D fan office ventilation example

Series
NK



Duct electric heater

Series
NK...U



Duct electric heater with a control unit

■ **Applications**

Duct electric heaters are designed for heating of intake air in rectangular ventilating system. The heaters are applied for air heating in ventilation and air conditioning systems in various premises.

■ **Design**

The casing and the terminal box are made of galvanized steel and the heating elements are of stainless steel. The models with the size from 400x200 to 600x350 the electric heating elements are extra ribbed to increase heat exchange surface. NK duct heaters are equipped with two overheating protection thermostats:

- ▶ basic protection with automatic restart (operating temperature +50 °C). After cooling the thermostat closes the control circuit of the heater automatically.
- ▶ emergency protection with manual restart (operating temperature above +90 °C). In case of response the power supply to the heater is allowed after the manual emergency reset only.
- ▶ the thermostat contacts are located in the terminal box for external connection.

Each standard size has several electric power capacity options. Higher capacity can be attained by means of installation of the heaters in series. In the heaters with heating capacity above 27 kW the tubular heating elements are grouped per 9 kW each. Each group consists of three Δ connected tubular elements.

■ **Duct electric heater with NK...U integrated temperature controller**

The NK heaters are available in modifications with a control unit for the heaters with power demand from 4.5 up to 54.0 kW to maintain set air temperature in the air duct.

The NK...U model with a control unit is equipped with a three phase triac power control unit.

Power control is effected by means of switching on/off the maximum load commutated by the semiconductor device that is free of any mechanical wear parts. The load commutation starts at zero current and load to

disable any magnetic field interferences. The load commutation starts at zero current and load to disable any magnetic field interferences.

- ▶ The NK...U heaters include two overheating protection thermostats:
 - ✓ the basic self-resetting overheat protection thermostat actuated at the temperature +50 °C. After cooling the thermostat closes the heater control circuit.
 - ✓ the emergency overheat protection thermostat with manual reset actuated at the temperature +90 °C. In case of the thermostat tripping power supply is resumed after manual alarm reset.
- ▶ Operation logic options for the NK...U heater with a control unit:
 - ✓ operation logic based on temperature sensor readings to maintain set air temperature in the air duct.
 - ✓ proportional electric heat control from 0 up to 100% with a 0-10 V control signal from the external controller.

The temperature is set with the integrated potentiometer. Optionally, an external 0-10 V control signal from another control unit may be connected to the control unit, which corresponds to the temperature 0 up to +40 °C.

- ▶ Offered temperature sensor options for the NK...U heater operation logic based on temperature sensor readings (not included into delivery set):

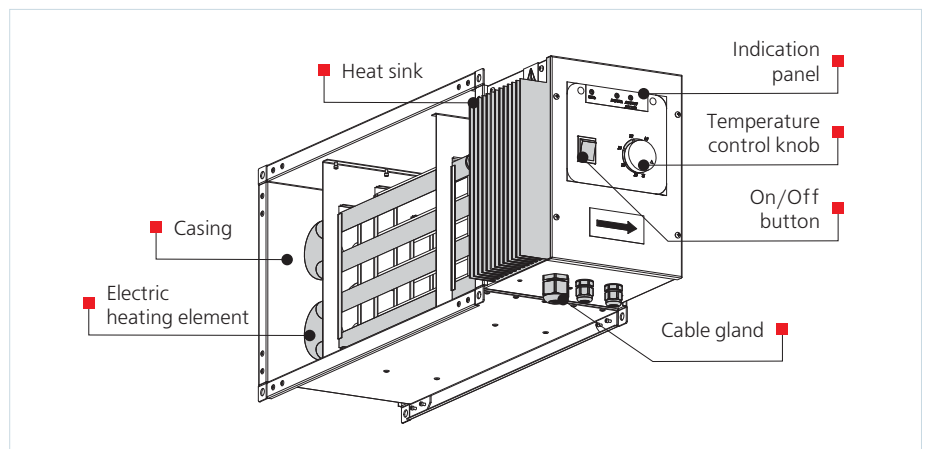

Designation key:

Series	Flange dimensions (WxH) [mm]	Heater power [kW]	Phase	Options
NK	400x200; 500x250; 500x300; 600x300; 600x350; 700x400; 800x500; 900x500; 1000x500	4,5; 6; 7,5; 9; 10,5; 12; 18; 21; 24; 27; 36; 45; 54	3 – three phase	U – integrated temperature control

Accessories



page 98



page 100



page 101

- ✓ KDT2-M1 duct temperature sensor enclosed in a protecting sleeve with a sensing tip, 100 up to 400 mm long
- ✓ KDT2-M duct temperature sensor enclosed in a protecting sleeve with a mounting flange, 100 up to 400 mm long
- ✓ KDT2-MK duct temperature sensor enclosed in a protecting sleeve with a mounting flange, 100 up to 400 mm long

■ Mounting

▶ The heater design ensures its mounting by means of flange connection. The air flow direction shall match the pointer on the filter. The duct heaters can be installed in any position except for with the electric control unit below to prevent

condensate penetration and wiring short circuit.

- ▶ The mounting shall be performed in such a way as to enable the uniform air stream distribution along the entire cross section.
- ▶ The air filter shall be installed at the heater inlet to protect the heating elements against pollution.
- ▶ We recommend to keep such distance between the heater and other system elements which is no less than the heater diagonal, i.e. the distance from one angle to another in its air passage part.
- ▶ The duct heaters are designed for the minimum air flow 1.5 m/s and the operating air temperature 40 °C. In case of speed control option ensure the minimum air flow through the heater.
- ▶ Power supply to the heater shall be disabled if the fan is not running.

▶ To ensure the correct and safe heater operation the automation system can be applied to ensure the complex control and protection:

- ✓ automatic control of heating elements capacity and air heating temperature;
- ✓ checking filter condition by means of differential pressure sensor;
- ✓ power supply disabling in case of the supply fan shutdown or airflow speed decrease as well as in case of the built-in overheating thermostats operation;
- ✓ shutoff of ventilating system with blowing of electrical heating elements.

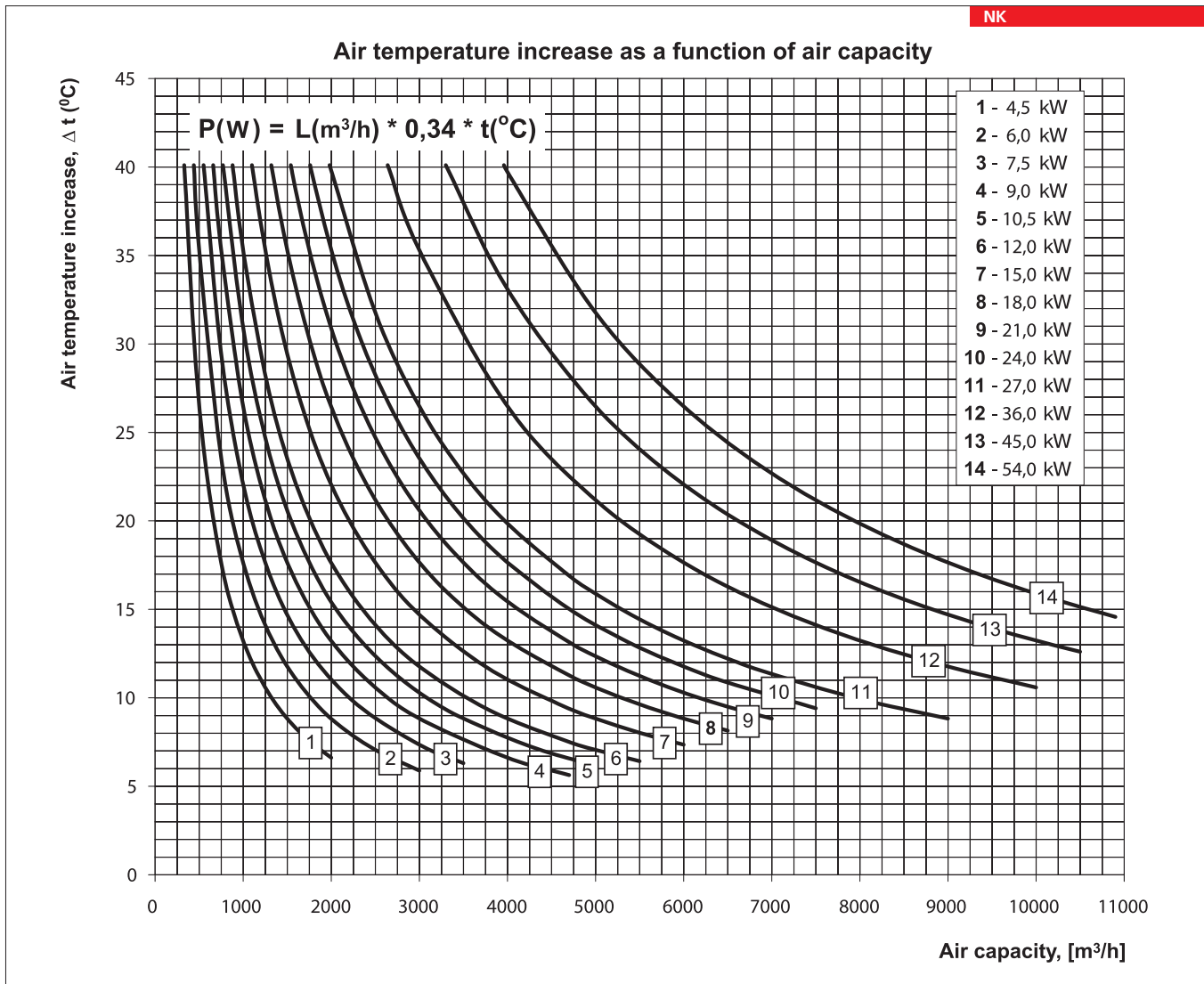

HEATERS

Technical data:

Type	Minimum air capacity [m ³ /h]	Current [A]	Voltage [V]	Power [kW]	Number of heating coils x capacity [kW]	Connection diagram for tubular heating elements
NK 400x200-4.5-3 / NK 400x200-4.5-3 U	330	6.5	400	4.5	3x1.5	Y
NK 400x200-6.0-3 / NK 400x200-6.0-3 U	440	8.7	400	6.0	3x2.0	Y
NK 400x200-7.5-3 / NK 400x200-7.5-3 U	550	10.9	400	7.5	3x2.5	Y
NK 400x200-9.0-3 / NK 400x200-9.0-3 U	660	13.0	400	9.0	3x3.0	Y
NK 400x200-10.5-3 / NK 400x200-10.5-3 U	770	15.2	400	10.5	3x3.5	Y
NK 400x200-12.0-3 / NK 400x200-12.0-3 U	880	17.4	400	12.0	3x4.0	Y
NK 400x200-15.0-3 / NK 400x200-15.0-3 U	1100	21.7	400	15.0	3x5.0	Y
NK 500x250-6.0-3 / NK 500x250-6.0-3 U	440	8.7	400	6.0	3x2.0	Y
NK 500x250-7.5-3 / NK 500x250-7.5-3 U	550	10.9	400	7.5	3x2.5	Y
NK 500x250-9.0-3 / NK 500x250-9.0-3 U	660	13.0	400	9.0	3x3.0	Y
NK 500x250-10.5-3 / NK 500x250-10.5-3 U	770	15.2	400	10.5	3x3.5	Y
NK 500x250-12.0-3 / NK 500x250-12.0-3 U	880	17.4	400	12.0	3x4.0	Y
NK 500x250-15.0-3 / NK 500x250-15.0-3 U	1100	21.7	400	15.0	3x5.0	Y
NK 500x250-18.0-3 / NK 500x250-18.0-3 U	1320	26.0	400	18.0	3x6.0	Y
NK 500x250-21.0-3 / NK 500x250-21.0-3 U	1540	30.0	400	21.0	3x7.0	Y
NK 500x300-6.0-3 / NK 500x300-6.0-3 U	440	8.7	400	6.0	3x2.0	Y
NK 500x300-7.5-3 / NK 500x300-7.5-3 U	550	10.9	400	7.5	3x2.5	Y
NK 500x300-9.0-3 / NK 500x300-9.0-3 U	660	13.0	400	9.0	3x3.0	Y
NK 500x300-10.5-3 / NK 500x300-10.5-3 U	770	15.2	400	10.5	3x3.5	Y
NK 500x300-12.0-3 / NK 500x300-12.0-3 U	880	17.4	400	12.0	3x4.0	Y
NK 500x300-15.0-3 / NK 500x300-15.0-3 U	1100	21.7	400	15.0	3x5.0	Y
NK 500x300-18.0-3 / NK 500x300-18.0-3 U	1320	26.0	400	18.0	3x6.0	Δ
NK 500x300-21.0-3 / NK 500x300-21.0-3 U	1540	30.0	400	21.0	3x7.0	Δ
NK 600x300-9.0-3 / NK 600x300-9.0-3 U	660	13.0	400	9.0	3x3.0	Y
NK 600x300-12.0-3 / NK 600x300-12.0-3 U	880	17.4	400	12.0	3x4.0	Y
NK 600x300-15.0-3 / NK 600x300-15.0-3 U	1100	21.7	400	15.0	3x5.0	Y
NK 600x300-18.0-3 / NK 600x300-18.0-3 U	1320	26.0	400	18.0	3x6.0	Δ
NK 600x300-21.0-3 / NK 600x300-21.0-3 U	1540	30.0	400	21.0	3x7.0	Δ
NK 600x300-24.0-3 / NK 600x300-24.0-3 U	1760	34.7	400	24.0	3x8.0	Δ
NK 600x350-9.0-3 / NK 600x350-9.0-3 U	660	13.0	400	9.0	3x3.0	Y
NK 600x350-12.0-3 / NK 600x350-12.0-3 U	880	17.4	400	12.0	3x4.0	Y
NK 600x350-15.0-3 / NK 600x350-15.0-3 U	1100	21.7	400	15.0	3x5.0	Y
NK 600x350-18.0-3 / NK 600x350-18.0-3 U	1320	26.0	400	18.0	3x6.0	Δ
NK 600x350-21.0-3 / NK 600x350-21.0-3 U	1540	30.0	400	21.0	3x7.0	Δ
NK 600x350-24.0-3 / NK 600x350-24.0-3 U	1760	34.7	400	24.0	3x8.0	Δ
NK 700x400-18.0-3 / NK 700x400-18.0-3 U	1320	26.0	400	18.0	6x3.0	Δ
NK 700x400-27.0-3 / NK 700x400-27.0-3 U	1980	39.0	400	27.0	9x3.0	Δ X 3 groups
NK 700x400-36.0-3 / NK 700x400-36.0-3 U	2640	52.0	400	36.0	12x3.0	Δ X 4 groups
NK 800x500-27.0-3 / NK 800x500-27.0-3 U	1980	39.0	400	27.0	9x3.0	Δ X 3 groups
NK 800x500-36.0-3 / NK 800x500-36.0-3 U	2640	52.0	400	36.0	12x3.0	Δ X 4 groups
NK 800x500-54.0-3 / NK 800x500-54.0-3 U	3960	78.0	400	54.0	18x3.0	Δ X 6 groups
NK 900x500-45.0-3 / NK 900x500-45.0-3 U	3300	65.0	400	45.0	15x3.0	Δ X 5 groups
NK 900x500-54.0-3 / NK 900x500-54.0-3 U	3960	78.0	400	54.0	18x3.0	Δ X 6 groups
NK 1000x500-45.0-3 / NK 1000x500-45.0-3 U	3300	65.0	400	45.0	15x3.0	Δ X 5 groups
NK 1000x500-54.0-3 / NK 1000x500-54.0-3 U	3960	78.0	400	54.0	18x3.0	Δ X 6 groups

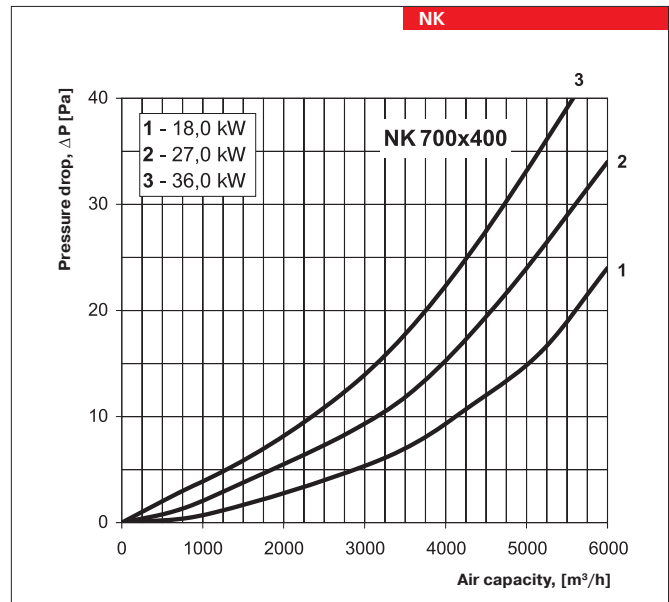
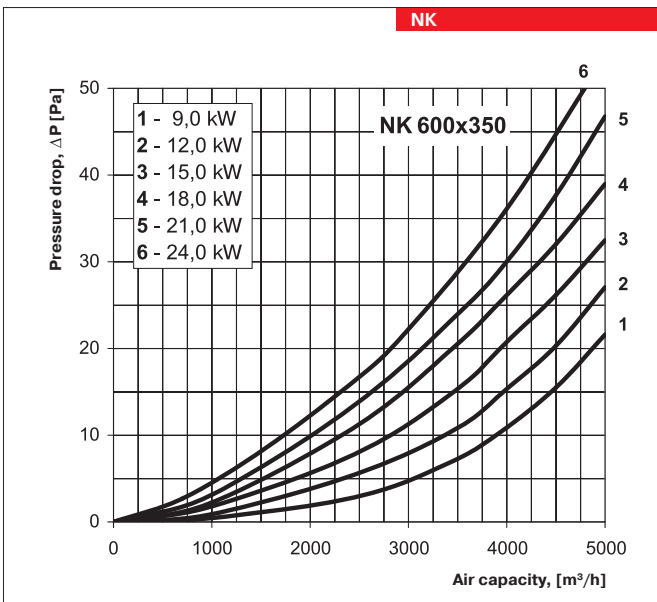
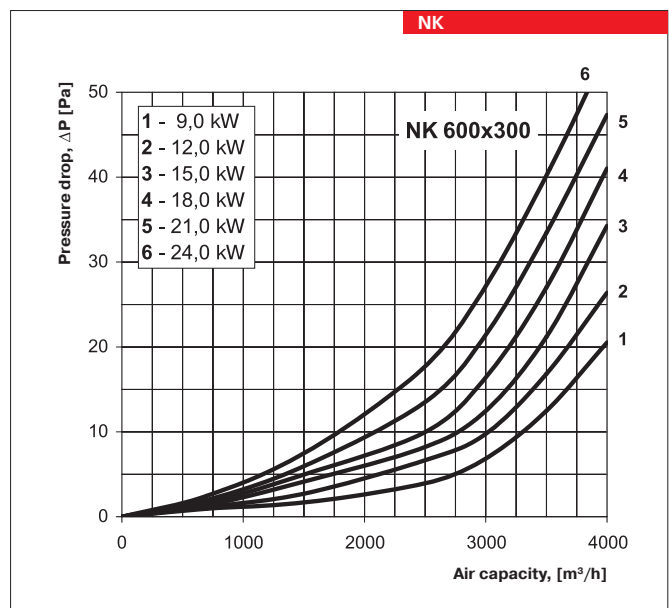
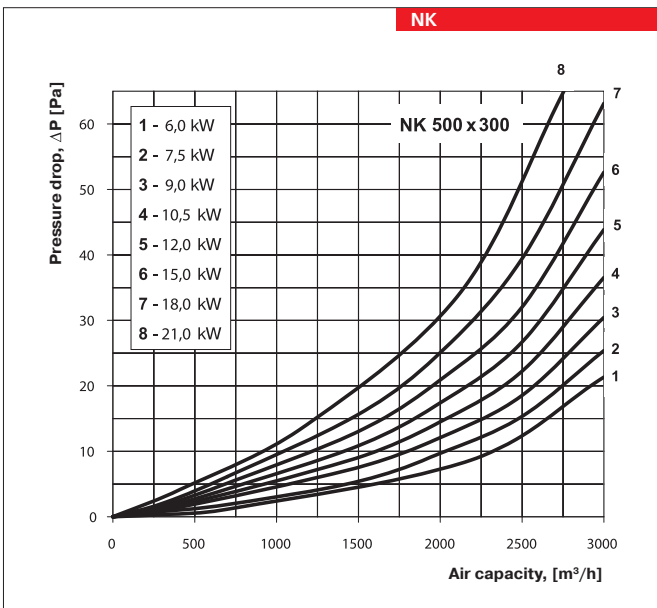
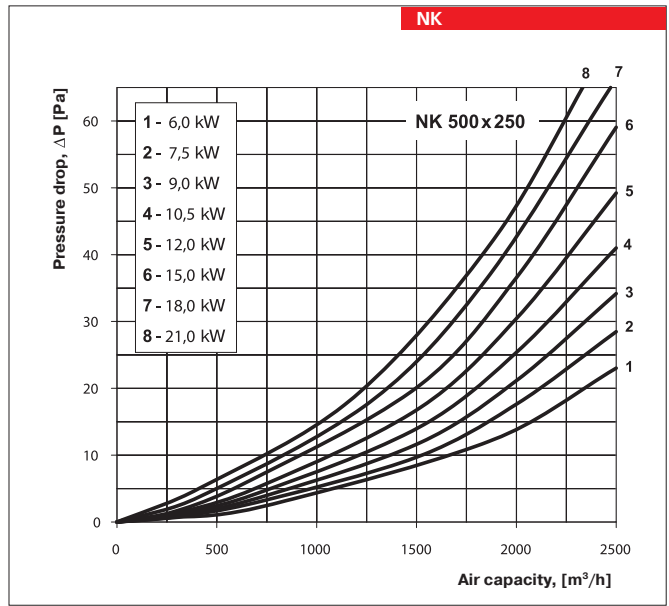
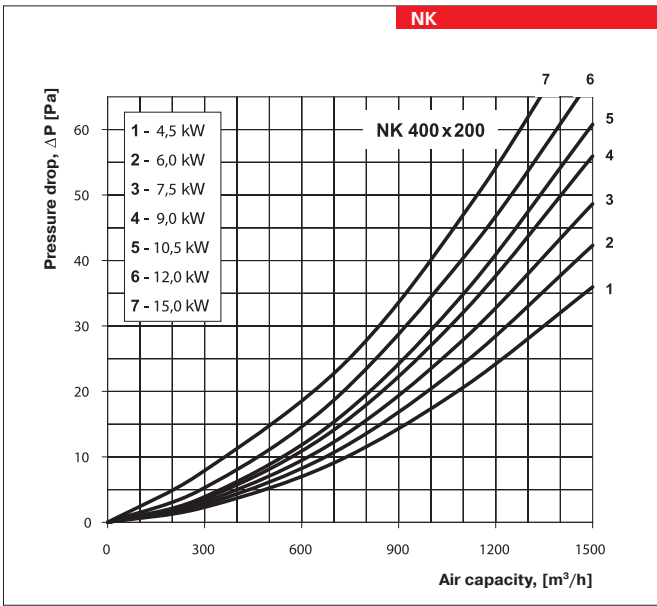

HEATERS

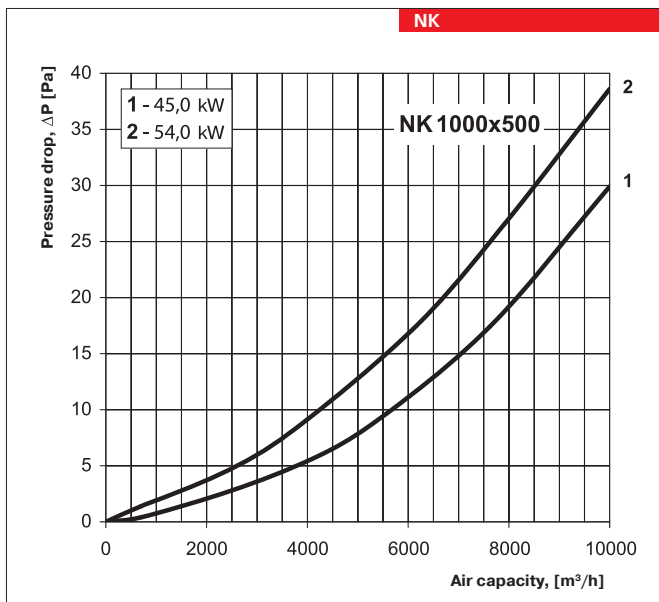
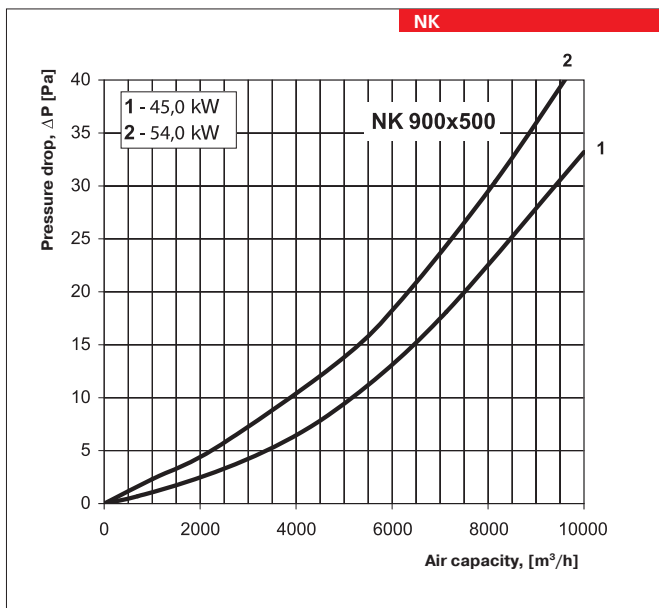
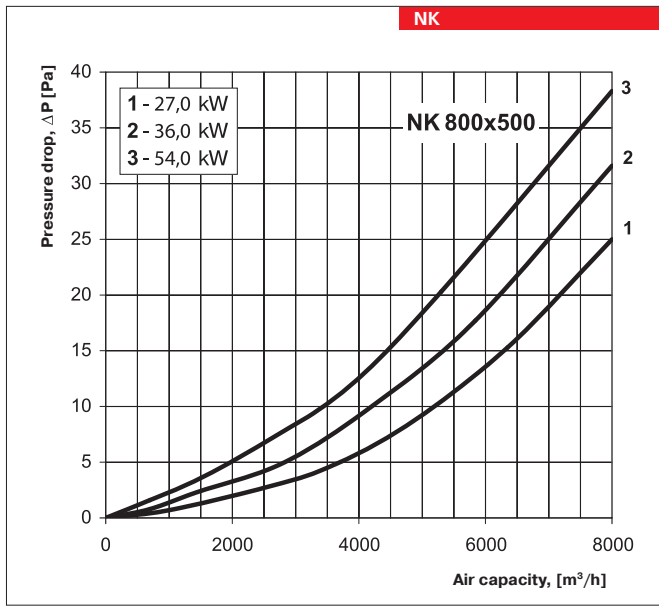

Overall dimensions:

Type	Dimensions [mm]							Weight [kg]
	B	B1	B2	H	H1	H2	L	
NK 400x200-4.5-3	400	420	540	200	220	240	200	6.5
NK 400x200-6.0-3	400	420	540	200	220	240	200	6.5
NK 400x200-7.5-3	400	420	540	200	220	240	200	6.5
NK 400x200-9.0-3	400	420	540	200	220	240	200	6.5
NK 400x200-10.5-3	400	420	540	200	220	240	200	6.5
NK 400x200-12.0-3	400	420	540	200	220	240	200	6.5
NK 400x200-15.0-3	400	420	540	200	220	240	200	6.5
NK 500x250-6.0-3	500	520	640	250	270	290	200	7.65
NK 500x250-7.5-3	500	520	640	250	270	290	200	7.65
NK 500x250-9.0-3	500	520	640	250	270	290	200	7.65
NK 500x250-10.5-3	500	520	640	250	270	290	200	7.65
NK 500x250-12.0-3	500	520	640	250	270	290	200	7.65
NK 500x250-15.0-3	500	520	640	250	270	290	200	7.65
NK 500x250-18.0-3	500	520	640	250	270	290	200	7.65
NK 500x250-21.0-3	500	520	640	250	270	290	200	7.65
NK 500x300-6.0-3	500	520	640	300	320	340	200	8.2
NK 500x300-7.5-3	500	520	640	300	320	340	200	8.2
NK 500x300-9.0-3	500	520	640	300	320	340	200	8.2
NK 500x300-10.5-3	500	520	640	300	320	340	200	8.2
NK 500x300-12.0-3	500	520	640	300	320	340	200	8.2
NK 500x300-15.0-3	500	520	640	300	320	340	200	8.2
NK 500x300-18.0-3	500	520	640	300	320	340	200	8.2
NK 500x300-21.0-3	500	520	640	300	320	340	200	8.2
NK 600x300-9.0-3	600	620	740	300	320	340	200	9.4
NK 600x300-12.0-3	600	620	740	300	320	340	200	9.4
NK 600x300-15.0-3	600	620	740	300	320	340	200	9.4
NK 600x300-18.0-3	600	620	740	300	320	340	200	9.4
NK 600x300-21.0-3	600	620	740	300	320	340	200	9.4
NK 600x300-24.0-3	600	620	740	300	320	340	200	9.4
NK 600x350-9.0-3	600	620	740	350	370	390	200	9.75
NK 600x350-12.0-3	600	620	740	350	370	390	200	9.75
NK 600x350-15.0-3	600	620	740	350	370	390	200	9.75
NK 600x350-18.0-3	600	620	740	350	370	390	200	9.75
NK 600x350-21.0-3	600	620	740	350	370	390	200	9.75
NK 600x350-24.0-3	600	620	740	350	370	390	200	9.75
NK 700x400-18.0-3	700	720	840	400	420	440	390	14
NK 700x400-27.0-3	700	720	840	400	420	440	510	18.5
NK 700x400-36.0-3	700	720	840	400	420	440	750	25
NK 800x500-27.0-3	800	820	940	500	520	540	390	19
NK 800x500-36.0-3	800	820	940	500	520	540	510	23.5
NK 800x500-54.0-3	800	820	940	500	520	540	750	30
NK 900x500-45.0-3	900	920	1040	500	520	540	750	31
NK 900x500-54.0-3	900	920	1040	500	520	540	750	33.5
NK 1000x500-45.0-3	1000	1020	1140	500	520	540	750	33
NK 1000x500-54.0-3	1000	1020	1140	500	520	540	750	36

Overall dimensions:

Type	Dimensions [mm]							Weight [kg]
	B	B1	B2	H	H1	H2	L	
NK 400x200-4.5-3 U	400	420	611	200	220	240	228	18.24
NK 400x200-6.0-3 U	400	420	611	200	220	240	228	18.24
NK 400x200-7.5-3 U	400	420	611	200	220	240	228	18.24
NK 400x200-9.0-3 U	400	420	665	200	220	240	228	18.52
NK 400x200-10.5-3 U	400	420	665	200	220	240	228	18.52
NK 400x200-12.0-3 U	400	420	665	200	220	240	228	18.52
NK 400x200-15.0-3 U	400	420	665	200	220	240	228	18.52
NK 500x250-6.0-3 U	500	520	702	250	270	290	228	22.4
NK 500x250-7.5-3 U	500	520	702	250	270	290	228	22.4
NK 500x250-9.0-3 U	500	520	702	250	270	290	228	23.0
NK 500x250-10.5-3 U	500	520	702	250	270	290	228	23.0
NK 500x250-12.0-3 U	500	520	702	250	270	290	228	23.0
NK 500x250-15.0-3 U	500	520	702	250	270	290	228	23.1
NK 500x250-18.0-3 U	500	520	702	250	270	290	228	23.1
NK 500x250-21.0-3 U	500	520	702	250	270	290	228	23.1
NK 500x300-6.0-3 U	500	520	702	300	320	340	228	22.9
NK 500x300-7.5-3 U	500	520	702	300	320	340	228	22.9
NK 500x300-9.0-3 U	500	520	702	300	320	340	228	23.5
NK 500x300-10.5-3 U	500	520	702	300	320	340	228	23.5
NK 500x300-12.0-3 U	500	520	702	300	320	340	228	23.5
NK 500x300-15.0-3 U	500	520	702	300	320	340	228	24.0
NK 500x300-18.0-3 U	500	520	702	300	320	340	228	24.0
NK 500x300-21.0-3 U	500	520	702	300	320	340	228	24.0
NK 600x300-9.0-3 U	600	620	802	300	320	340	228	27.0
NK 600x300-12.0-3 U	600	620	802	300	320	340	228	27.0
NK 600x300-15.0-3 U	600	620	802	300	320	340	228	27.5
NK 600x300-18.0-3 U	600	620	802	300	320	340	228	27.5
NK 600x300-21.0-3 U	600	620	802	300	320	340	228	27.5
NK 600x300-24.0-3 U	600	620	802	300	320	340	228	27.5
NK 600x350-9.0-3 U	600	620	802	350	370	390	228	28.2
NK 600x350-12.0-3 U	600	620	802	350	370	390	228	28.2
NK 600x350-15.0-3 U	600	620	802	350	370	390	228	28.5
NK 600x350-18.0-3 U	600	620	802	350	370	390	228	28.5
NK 600x350-21.0-3 U	600	620	802	350	370	390	228	28.5
NK 600x350-24.0-3 U	600	620	802	350	370	390	228	28.5
NK 700x400-18.0-3 U	700	720	924	400	420	440	410	16.8
NK 700x400-27.0-3 U	700	720	924	400	420	440	530	21.0
NK 700x400-36.0-3 U	700	720	924	400	420	440	750	28.0
NK 800x500-27.0-3 U	800	820	1024	500	520	540	410	20.6
NK 800x500-36.0-3 U	800	820	1024	500	520	540	530	25.9
NK 800x500-54.0-3 U	800	820	1024	500	520	540	750	36.1
NK 900x500-45.0-3 U	900	920	1130	500	520	540	750	33.4
NK 900x500-54.0-3 U	900	920	1130	500	520	540	750	38.0
NK 1000x500-45.0-3 U	1000	1020	1230	500	520	540	750	35.5
NK 1000x500-54.0-3 U	1000	1020	1230	500	520	540	750	41.2

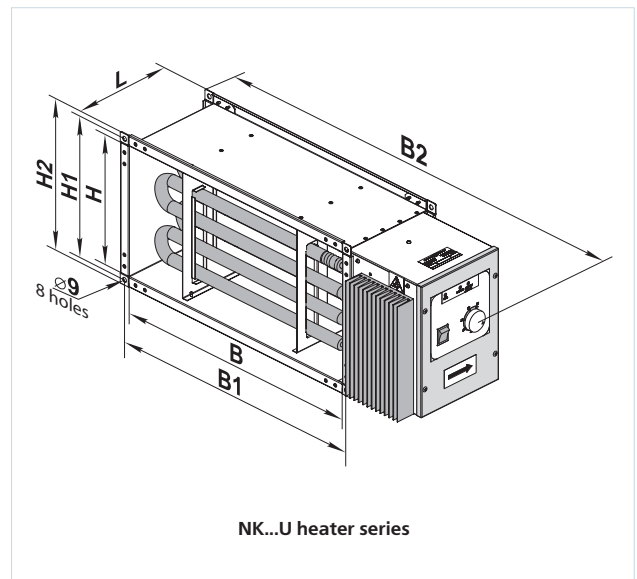
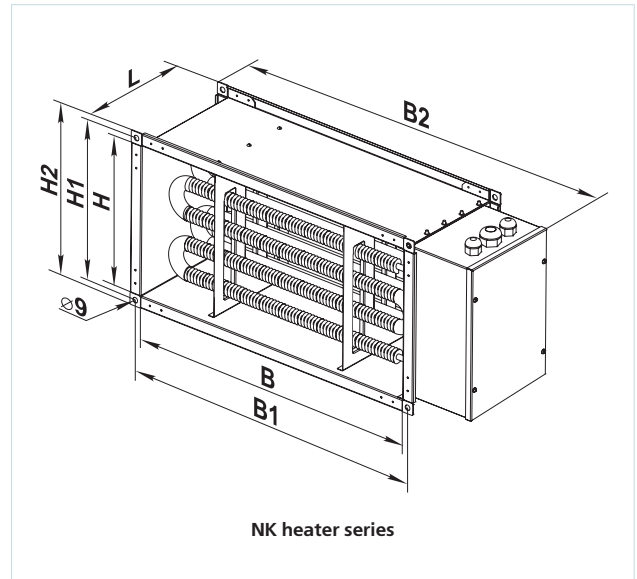

Series
NKV



■ **Applications**

Duct water heaters are designed for heating of supply air in rectangular ventilating system and are applicable in supply or supply and exhaust units.

■ **Design**

The heater casing is made of galvanized steel, the manifold is made of copper tubes and the heat exchange surface is made of aluminium plates. The heaters are available in 2, 3 or 4 rows modifications and designed for operation at maximum operating pressure 1.6 MPa (16 bar) and maximum operating temperature +100 °C. The exhaust manifold of the heater has a branch pipe for submersible temperature sensor or iicng protecting device. The heater has a nipple to provide the system deaeration.

■ **Mounting**

- ▶ The heater design ensures its mounting by means of a flange connection. The water heater can be installed in any position to enable its deaeration. The air stream shall match the pointer on the heater.
- ▶ The heater shall be installed in such a way as to enable the uniform air distribution along the entire cross section.
- ▶ The air filter shall be installed at the heater inlet to provide protection against dust and dirt.
- ▶ The heater can be installed both at the fan inlet or outlet. If the heater is located at the fan outlet the air duct length between the heater and the fan shall be at least 1-1.5 m to ensure the air flow stabilization as well as permissible air temperature level inside the fan.
- ▶ The heater shall be connected on the counter-flow basis, otherwise its efficiency can drop by 5-15%. All the nomographic charts in the catalogue are valid for such connection.

- ▶ If water serves as a heat transfer agent the heaters are designed for indoor installation only. For outdoor installation use antifreeze mixture (i.e. ethylene glycol solution).
- ▶ To ensure the correct and safe heater operation use the automation system that provides the complex control and freezing protection:
 - ✓ automatic control of heating elements capacity and air heating temperature;
 - ✓ switching ventilating system on with preliminary heating by the heater;
 - ✓ use of air curtains equipped with spring-loaded actuator;
 - ✓ filter checking by means of differential pressure sensor;
 - ✓ fan shutdown in case of water coil freezing danger.

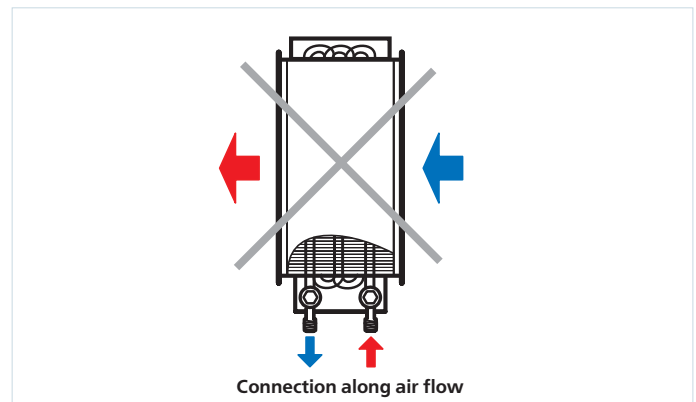
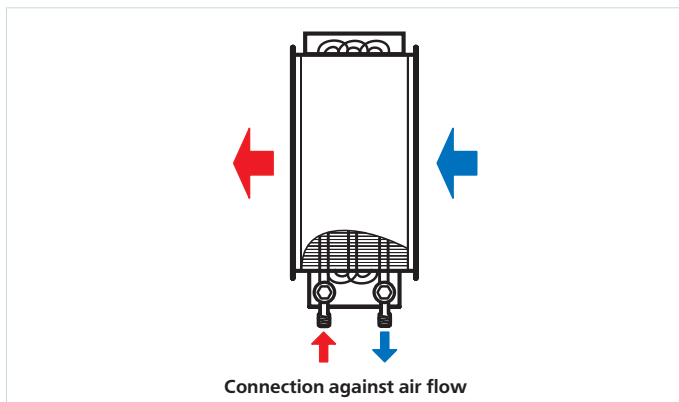

Designation key:

Series	Flange dimensions (WxH) [mm]	Number of water coil rows
NKV	400x200; 500x250; 500x300; 600x300; 600x350; 700x400; 800x500; 900x500; 1000x500	2; 3; 4

Accessories



page 60

Overall dimensions:

Type	Dimensions [mm]												Number of water coil rows	Weight [kg]
	B	B1	B2	B3	H	H1	H2	H3	L	L1	L2	K		
NKV 400x200-2	400	420	440	565	200	220	240	150	200	43	43	G 3/4"	2	7.6
NKV 400x200-4	400	420	440	565	200	220	240	150	200	38	65	G 3/4"	4	8.1
NKV 500x250-2	500	520	540	665	250	270	290	200	200	43	43	G 3/4"	2	15.8
NKV 500x250-4	500	520	540	665	250	270	290	200	200	38	65	G 3/4"	4	16.3
NKV 500x300-2	500	520	540	665	300	320	340	250	200	43	43	G 1"	2	11.5
NKV 500x300-4	500	520	540	665	300	320	340	250	200	38	65	G 1"	4	12.0
NKV 600x300-2	600	620	640	765	300	320	340	250	200	43	43	G 1"	2	21.8
NKV 600x300-4	600	620	640	765	300	320	340	250	200	38	65	G 1"	4	22.3
NKV 600x350-2	600	620	640	765	350	370	390	300	200	43	43	G 1"	2	22.4
NKV 600x350-4	600	620	640	765	350	370	390	300	200	38	65	G 1"	4	22.9
NKV 700x400-2	700	720	740	865	400	420	440	350	200	36	47	G 1"	2	27.8
NKV 700x400-3	700	720	740	865	400	420	440	350	200	42	58	G 1"	3	28.4
NKV 800x500-2	800	820	840	965	500	520	540	450	200	36	47	G 1"	2	36.5
NKV 800x500-3	800	820	840	965	500	520	540	450	200	42	58	G 1"	3	37.2
NKV 900x500-2	900	920	940	1065	500	520	540	450	200	36	47	G 1"	2	40.4
NKV 900x500-3	900	920	940	1065	500	520	540	450	200	42	58	G 1"	3	41.2
NKV 1000x500-2	1000	1020	1040	1165	500	520	540	450	200	36	47	G 1"	2	44.3
NKV 1000x500-3	1000	1020	1040	1165	500	520	540	450	200	42	58	G 1"	3	45.2

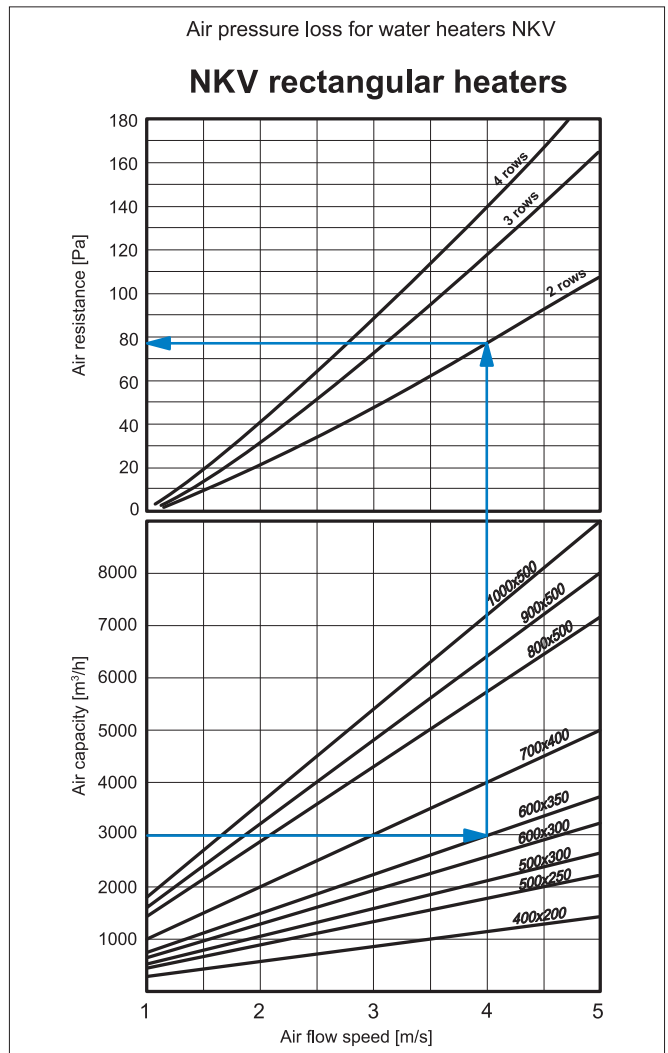
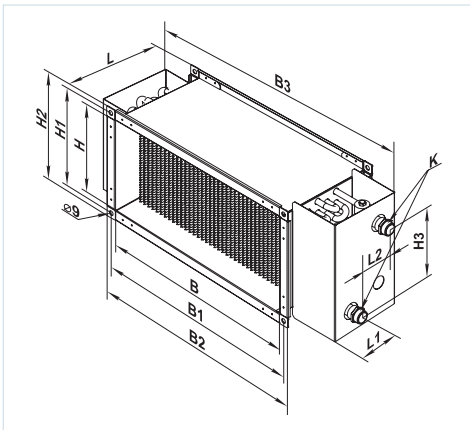

NKV

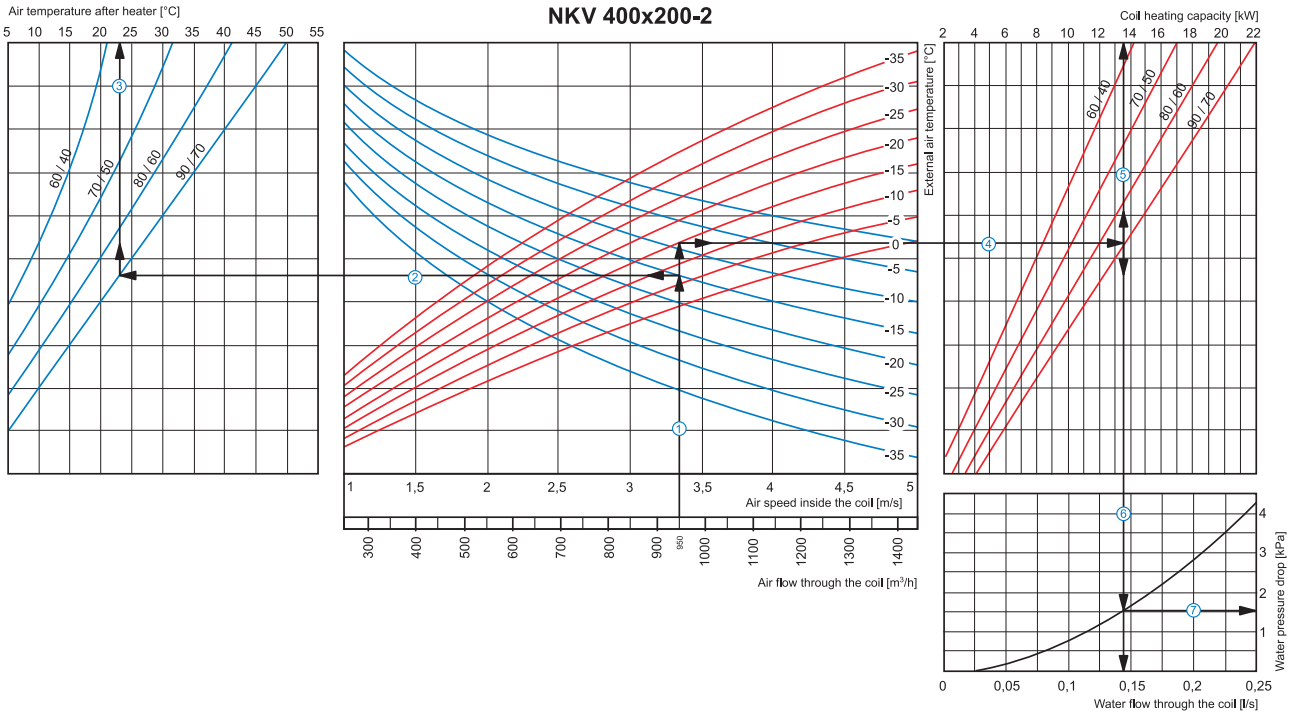

How to use water heater diagrams

Air Speed. Starting from 950 m³/h on the air flow scale draw a vertical line ① till the air speed axis which makes about 3.35 m/s.

Supply air temperature. Prolong the line ① up to the point where it crosses the outside air temperature (blue curve), e.g. -15 °C; then draw a horizontal line ② from this point to the left till crossing water in/out temperature curve (90/70 °C). From this point draw a vertical line ③ to the supply air temperature axis on top of the graphic (+23 °C).

Heating coil capacity. Prolong the line ① up to the point where it crosses the outside air temperature indicated as red curve (e.g., -15 °C) and draw a horizontal line ④ from this point to the right to the intersection of water in/out temperature curve (e.g., 90/70 °C). From this point draw a vertical line ⑤ up to the scale of heating coil capacity (13.5 kW).

Water flow. Prolong the line ⑤ down to water flow axis at the bottom of the graphic (0.14 l/s).

Water pressure drop. Draw the line ⑦ from the point where line ⑥ crosses the black curve to the pressure drop axis. (1.5 kPa).

NKV

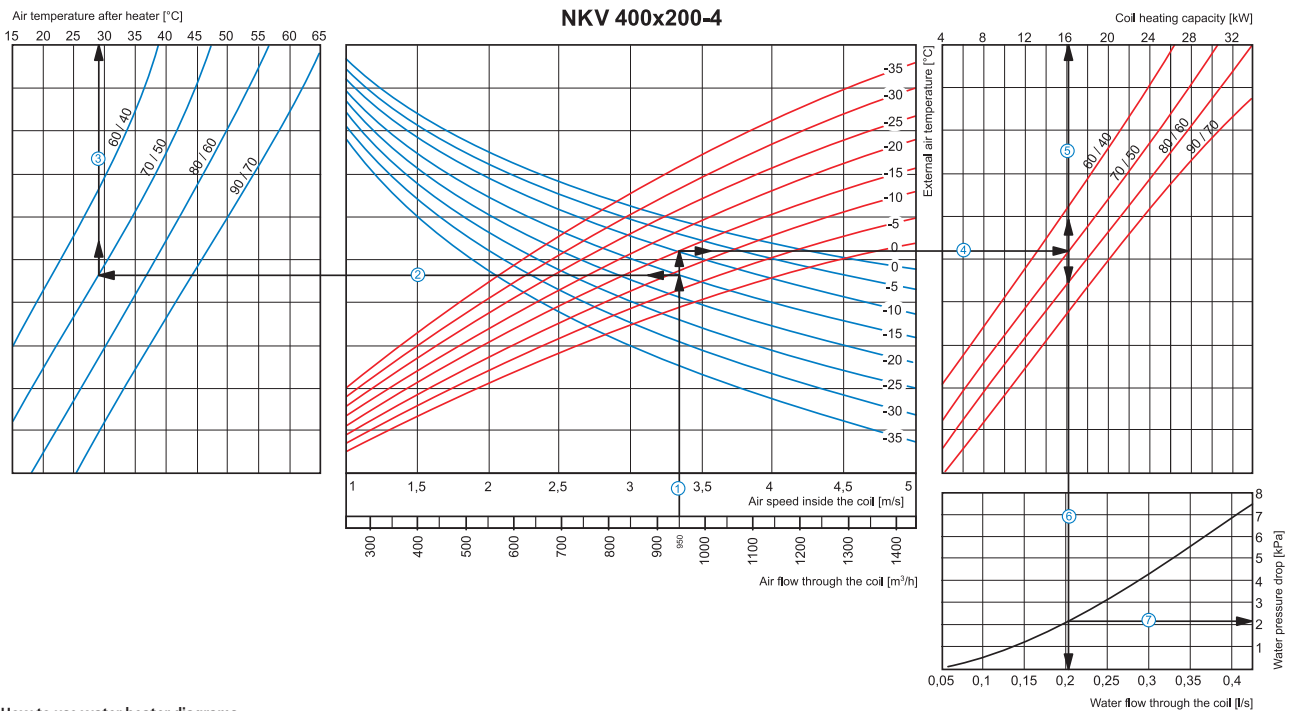

How to use water heater diagrams

Air Speed. Starting from 950 m³/h on the air flow scale draw a vertical line ① till the air speed axis which makes about 3.35 m/s.

Supply air temperature. Prolong the line ① up to the point where it crosses the outside air temperature (blue curve), e.g. -15 °C; then draw a horizontal line ② from this point to the left till crossing water in/out temperature curve (70/50 °C). From this point draw a vertical line ③ to the supply air temperature axis on top of the graphic (+29 °C).

Heating coil capacity. Prolong the line ① up to the point where it crosses the outside air temperature indicated as red curve (e.g., -15 °C) and draw a horizontal line ④ from this point to the right to the intersection of water in/out temperature curve (e.g., 70/50 °C). From this point draw a vertical line ⑤ up to the scale of heating coil capacity (16.0 kW).

Water flow. Prolong the line ⑤ down to water flow axis at the bottom of the graphic ⑥ (0.2 l/s).

Water pressure drop. Draw the line ⑦ from the point where line ⑥ crosses the black curve to the pressure drop axis. (2.1 kPa).

NKV

Air temperature after heater [°C]
5 10 15 20 25 30 35 40 45 50 55

NKV 500x250-2

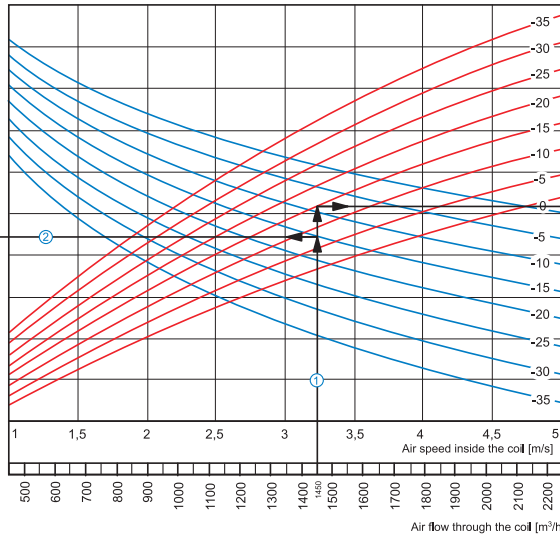
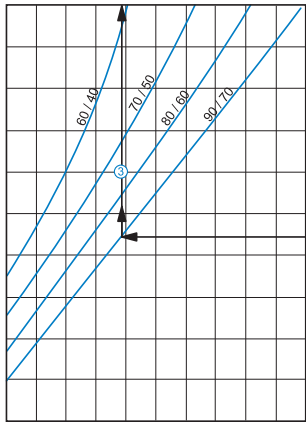

Coil heating capacity [kW]

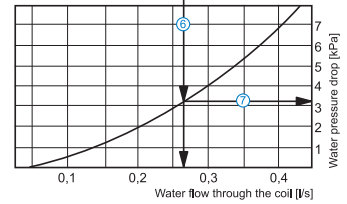
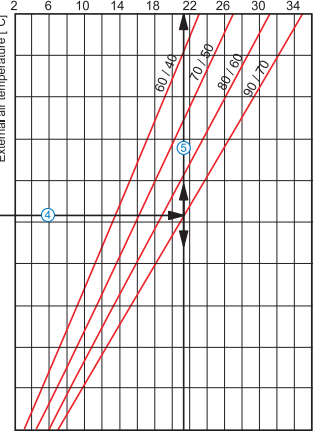

How to use water heater diagrams

Air Speed. Starting from 1450 m³/h on the air flow scale draw a vertical line ① till the air speed axis which makes about 3.2 m/s.

- Supply air temperature. Prolong the line ① up to the point where it crosses the outside air temperature (blue curve), e.g. -15 °C; then draw a horizontal line ② from this point to the left till crossing water in/out temperature curve (90/70 °C). From this point draw a vertical line ③ to the supply air temperature axis on top of the graphic (+24 °C).
- Heating coil capacity. Prolong the line ① up to the point where it crosses the outside air temperature indicated as red curve (e.g., -15 °C) and draw a horizontal line ④ from this point to the right to the intersection of water in/out temperature curve (e.g., 90/70 °C). From this point draw a vertical line ⑤ up to the scale of heating coil capacity (21.5 kW).
- water flow. Prolong the line ⑤ down to water flow axis at the bottom of the graphic ⑥ (0.27 l/s).
- Water pressure drop. Draw the line ⑦ from the point where line ⑥ crosses the black curve to the pressure drop axis. (3.2 kPa).

NKV

Air temperature after heater [°C]
15 20 25 30 35 40 45 50 55 60 65

NKV 500x250-4

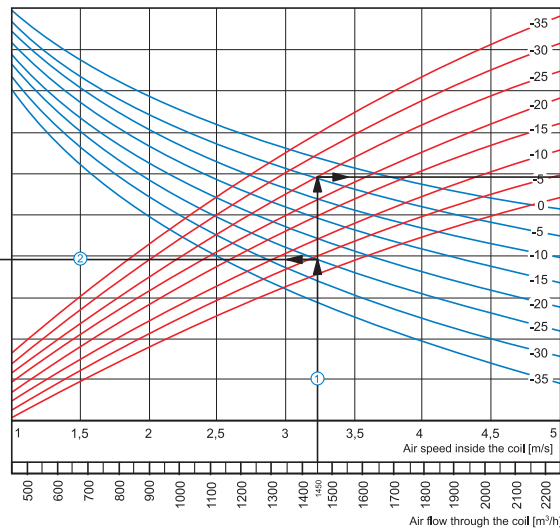
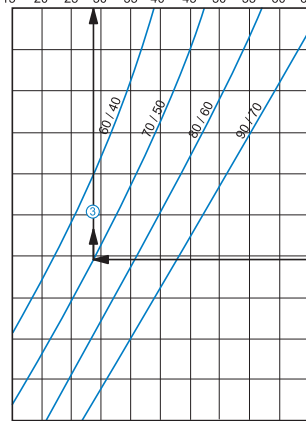

Coil heating capacity [kW]

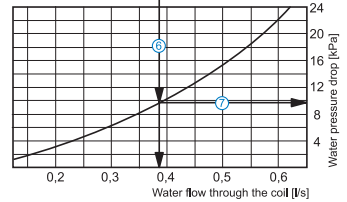
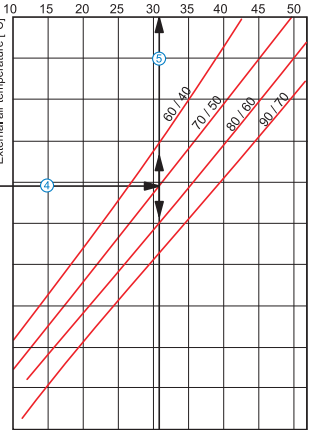

How to use water heater diagrams

Air Speed. Starting from 1450 m³/h on the air flow scale draw a vertical line ① till the air speed axis which makes about 3.2 m/s.

- Supply air temperature. Prolong the line ① up to the point where it crosses the outside air temperature (blue curve), e.g. -25 °C; then draw a horizontal line ② from this point to the left till crossing water in/out temperature curve (70/50 °C). From this point draw a vertical line ③ to the supply air temperature axis on top of the graphic (+28 °C).
- Heating coil capacity. Prolong the line ① up to the point where it crosses the outside air temperature indicated as red curve (e.g., -25 °C) and draw a horizontal line ④ from this point to the right to the intersection of water in/out temperature curve (e.g., 70/50 °C). From this point draw a vertical line ⑤ up to the scale of heating coil capacity (31.0 kW).
- water flow. Prolong the line ⑤ down to water flow axis at the bottom of the graphic ⑥ (0.38 l/s).
- Water pressure drop. Draw the line ⑦ from the point where line ⑥ crosses the black curve to the pressure drop axis. (9.8 kPa).

NKV

Air temperature after heater [°C]
5 10 15 20 25 30 35 40 45 50 55

NKV 500x300-2

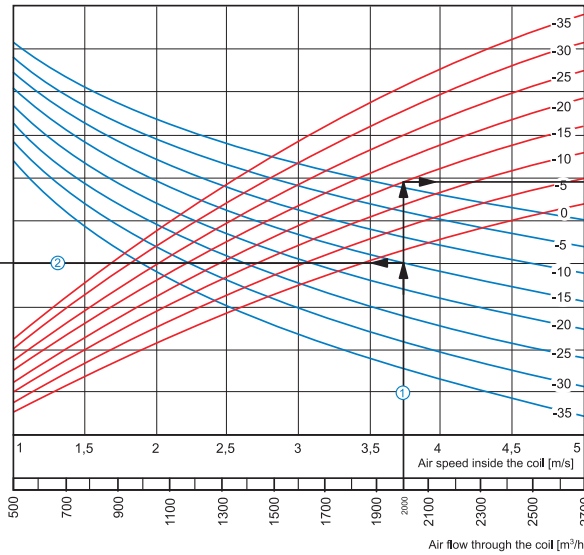
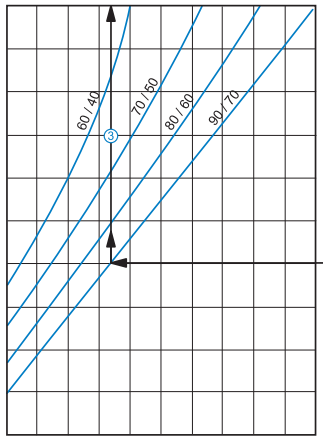

Coil heating capacity [kW]
0 6 12 18 24 30 36 42

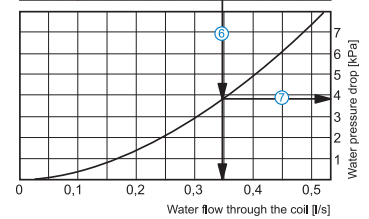
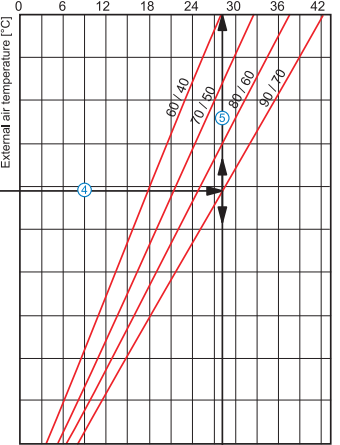

How to use water heater diagrams

Air Speed. Starting from 2000 m³/h on the air flow scale draw a vertical line ① till the air speed axis which makes about 3.75 m/s.

Supply air temperature. Prolong the line ① up to the point where it crosses the outside air temperature (blue curve), e.g. -15 °C; then draw a horizontal line ② from this point to the left till crossing water in/out temperature curve (90/70 °C). From this point draw a vertical line ③ to the supply air temperature axis on top of the graphic (+22 °C).

Heating coil capacity. Prolong the line ① up to the point where it crosses the outside air temperature indicated as red curve (e.g., -15 °C) and draw a horizontal line ④ from this point to the right to the intersection of water in/out temperature curve (e.g., 90/70 °C). From this point draw a vertical line ⑤ up to the scale of heating coil capacity (28.0 kW).

Water flow. Prolong the line ⑤ down to water flow axis at the bottom of the graphic ⑥ (0.35 l/s).

Water pressure drop. Draw the line ⑦ from the point where line ⑥ crosses the black curve to the pressure drop axis. (3.8 kPa).

NKV

Air temperature after heater [°C]
15 20 25 30 35 40 45 50 55 60 65

NKV 500x300-4

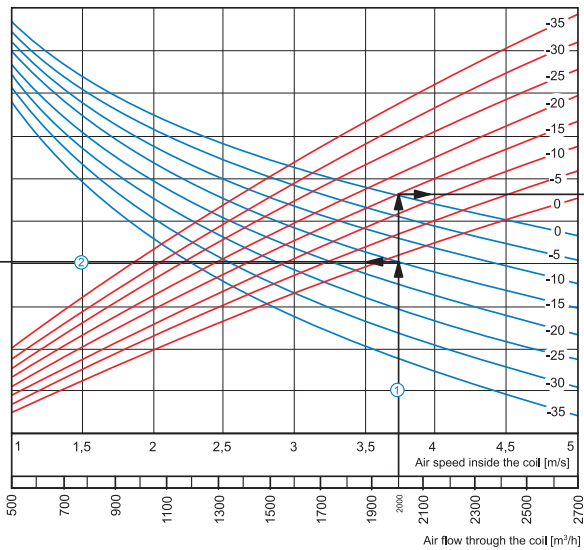
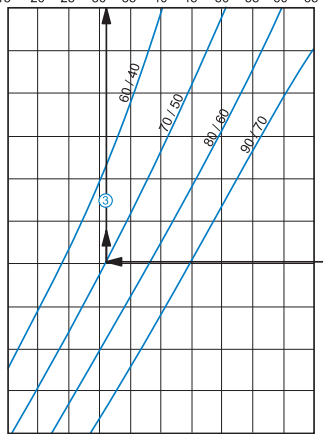

Coil heating capacity [kW]
10 20 30 40 50 60

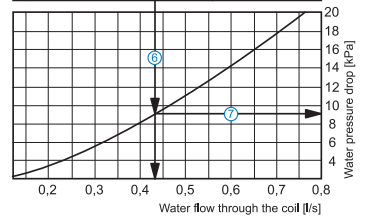
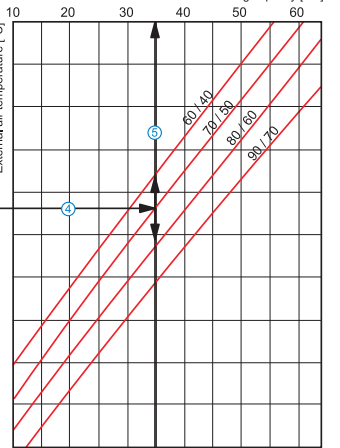

How to use water heater diagrams

Air Speed. Starting from 2000 m³/h on the air flow scale draw a vertical line ① till the air speed axis which makes about 3.75 m/s.

Supply air temperature. Prolong the line ① up to the point where it crosses the outside air temperature (blue curve), e.g. -15 °C; then draw a horizontal line ② from this point to the left till crossing water in/out temperature curve (70/50 °C). From this point draw a vertical line ③ to the supply air temperature axis on top of the graphic (+31 °C).

Heating coil capacity. Prolong the line ① up to the point where it crosses the outside air temperature indicated as red curve (e.g., -15 °C) and draw a horizontal line ④ from this point to the right to the intersection of water in/out temperature curve (e.g., 70/50 °C). From this point draw a vertical line ⑤ up to the scale of heating coil capacity (35.0 kW).

Water flow. Prolong the line ⑤ down to water flow axis at the bottom of the graphic ⑥ (0.43 l/s).

Water pressure drop. Draw the line ⑦ from the point where line ⑥ crosses the black curve to the pressure drop axis. (9.0 kPa).

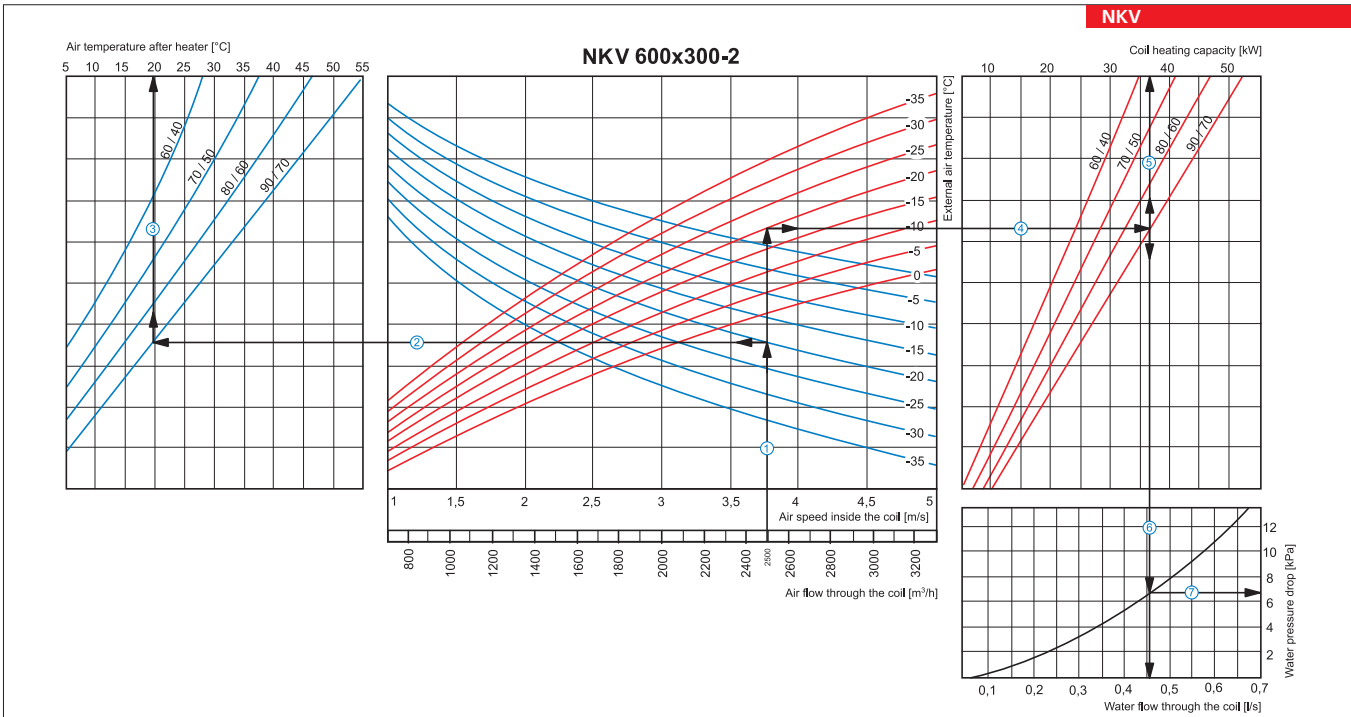

How to use water heater diagrams

Air Speed. Starting from 2500 m³/h on the air flow scale draw a vertical line ① till the air speed axis which makes about 3.75 m/s.

- **Supply air temperature.** Prolong the line ① up to the point where it crosses the outside air temperature (blue curve), e.g. -20 °C; then draw a horizontal line ② from this point to the left till crossing water in/out temperature curve (90/70 °C). From this point draw a vertical line ③ to the supply air temperature axis on top of the graphic (+20 °C).
- **Heating coil capacity.** Prolong the line ① up to the point where it crosses the outside air temperature indicated as red curve (e.g., -20 °C) and draw a horizontal line ④ from this point to the right to the intersection of water in/out temperature curve (e.g., 90/70 °C). From this point draw a vertical line ⑤ up to the scale of heating coil capacity (37.0 kW).
- **Water flow.** Prolong the line ⑤ down to water flow axis at the bottom of the graphic ⑥ (0.46 l/s).
- **Water pressure drop.** Draw the line ⑦ from the point where line ⑥ crosses the black curve to the pressure drop axis. (6.7 kPa).

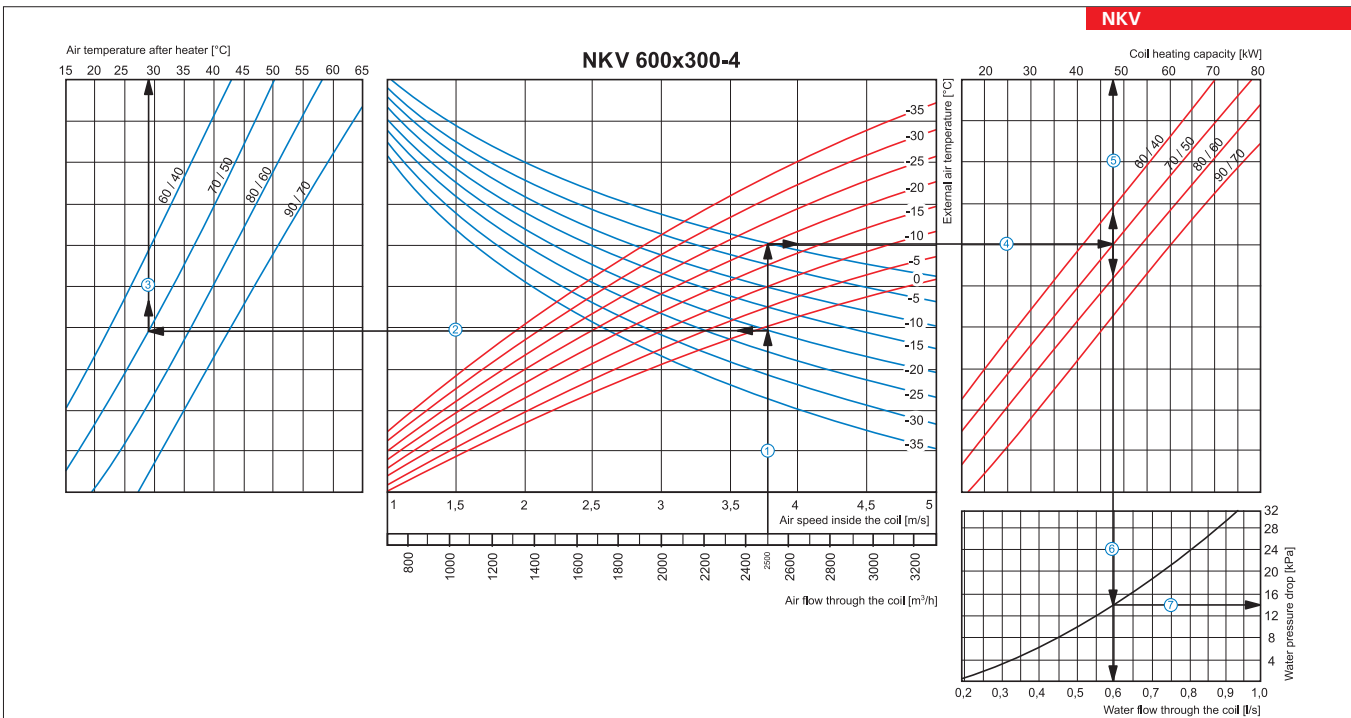

How to use water heater diagrams

Air Speed. Starting from 2500 m³/h on the air flow scale draw a vertical line ① till the air speed axis which makes about 3.75 m/s.

- **Supply air temperature.** Prolong the line ① up to the point where it crosses the outside air temperature (blue curve), e.g. -20 °C; then draw a horizontal line ② from this point to the left till crossing water in/out temperature curve (70/50 °C). From this point draw a vertical line ③ to the supply air temperature axis on top of the graphic (+29 °C).
- **Heating coil capacity.** Prolong the line ① up to the point where it crosses the outside air temperature indicated as red curve (e.g., -20 °C) and draw a horizontal line ④ from this point to the right to the intersection of water in/out temperature curve (e.g., 70/50 °C). From this point draw a vertical line ⑤ up to the scale of heating coil capacity (48.0 kW).
- **Water flow.** Prolong the line ⑤ down to water flow axis at the bottom of the graphic ⑥ (0.6 l/s).
- **Water pressure drop.** Draw the line ⑦ from the point where line ⑥ crosses the black curve to the pressure drop axis. (14.0 kPa).

NKV

NKV 600x350-2

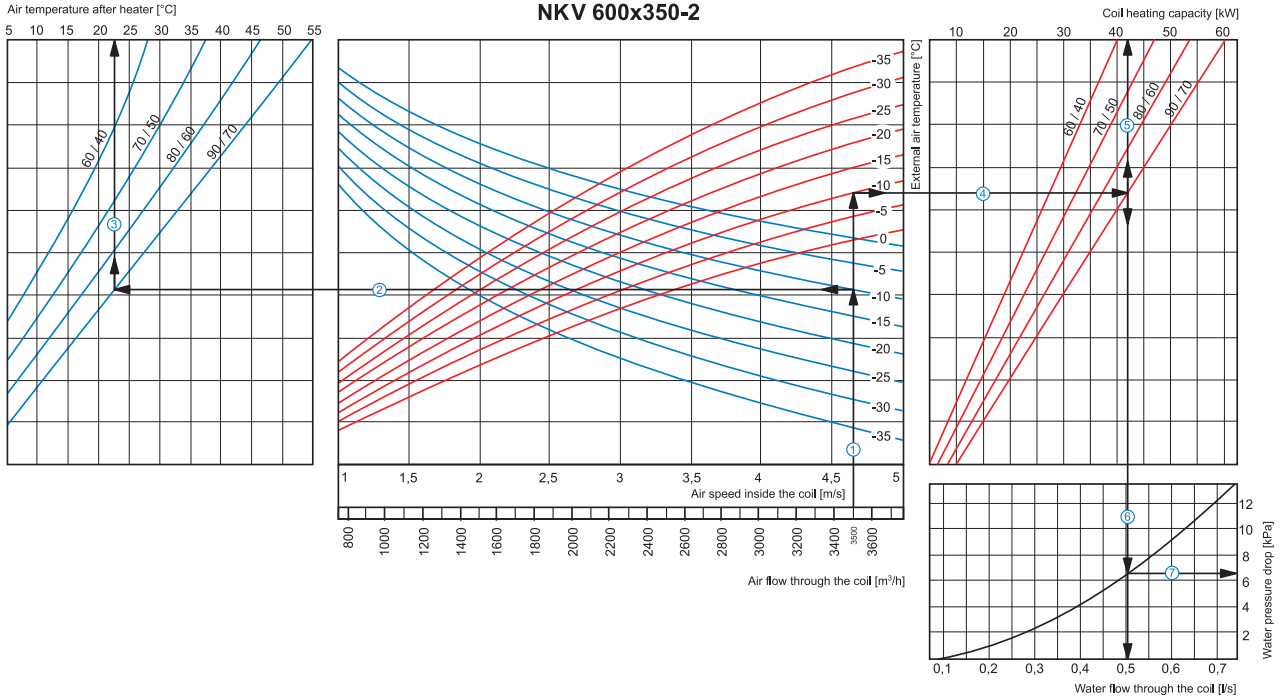

How to use water heater diagrams

Air Speed. Starting from 3500 m³/h on the air flow scale draw a vertical line ① till the air speed axis which makes about 4.65 m/s.

- Supply air temperature. Prolong the line ① up to the point where it crosses the outside air temperature (blue curve), e.g. -10 °C; then draw a horizontal line ② from this point to the left till crossing water in/out temperature curve (90/70 °C). From this point draw a vertical line ③ to the supply air temperature axis on top of the graphic (+22.5 °C).
- Heating coil capacity. Prolong the line ① up to the point where it crosses the outside air temperature indicated as red curve (e.g., -10 °C) and draw a horizontal line ④ from this point to the right to the intersection of water in/out temperature curve (e.g., 90/70 °C). From this point draw a vertical line ⑤ up to the scale of heating coil capacity (42.0 kW).
- water flow. Prolong the line ⑤ down to water flow axis at the bottom of the graphic ⑥ (0.5 l/s).
- Water pressure drop. Draw the line ⑦ from the point where line ⑥ crosses the black curve to the pressure drop axis. (6.5 kPa).

NKV

NKV 600x350-4

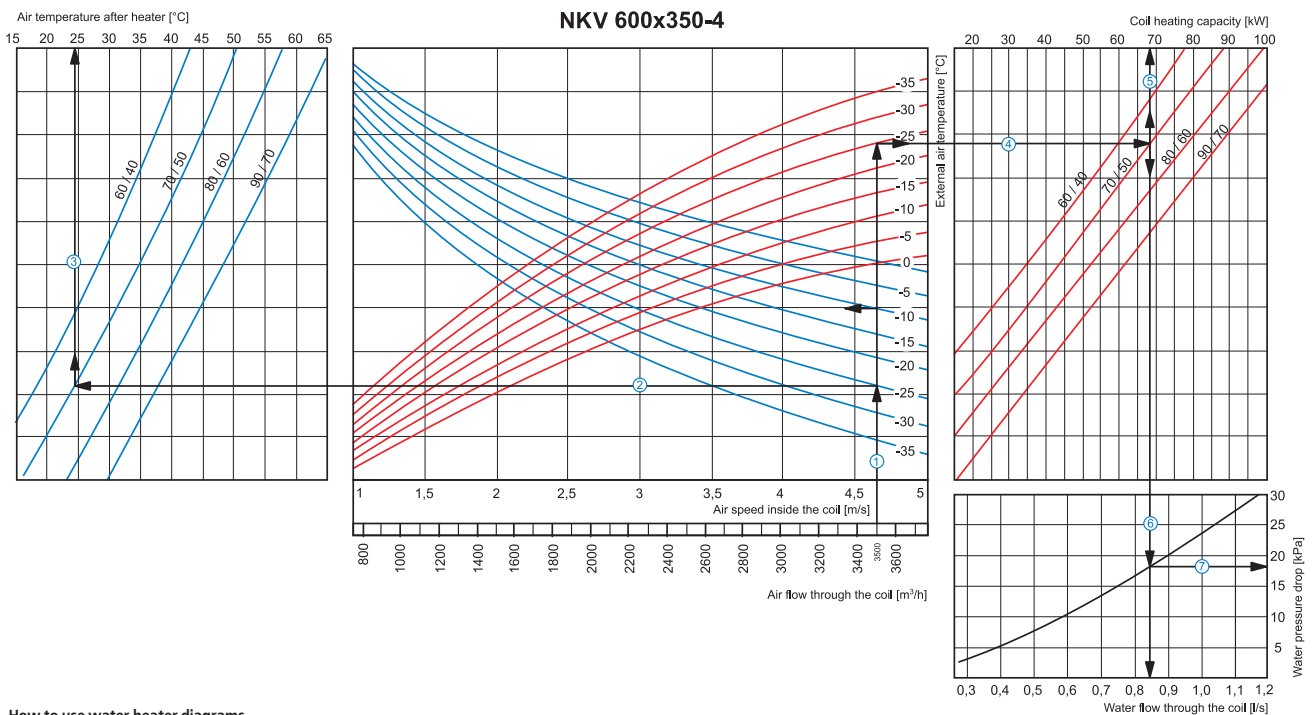

How to use water heater diagrams

Air Speed. Starting from 3500 m³/h on the air flow scale draw a vertical line ① till the air speed axis which makes about 4.65 m/s.

- Supply air temperature. Prolong the line ① up to the point where it crosses the outside air temperature (blue curve), e.g. -25 °C; then draw a horizontal line ② from this point to the left till crossing water in/out temperature curve (70/50 °C). From this point draw a vertical line ③ to the supply air temperature axis on top of the graphic (+24 °C).
- Heating coil capacity. Prolong the line ① up to the point where it crosses the outside air temperature indicated as red curve (e.g., -25 °C) and draw a horizontal line ④ from this point to the right to the intersection of water in/out temperature curve (e.g., 70/50 °C). From this point draw a vertical line ⑤ up to the scale of heating coil capacity (68.0 kW).
- water flow. Prolong the line ⑤ down to water flow axis at the bottom of the graphic ⑥ (0.84 l/s).
- Water pressure drop. Draw the line ⑦ from the point where line ⑥ crosses the black curve to the pressure drop axis. (18.0 kPa).

NKV

NKV 700x400-2

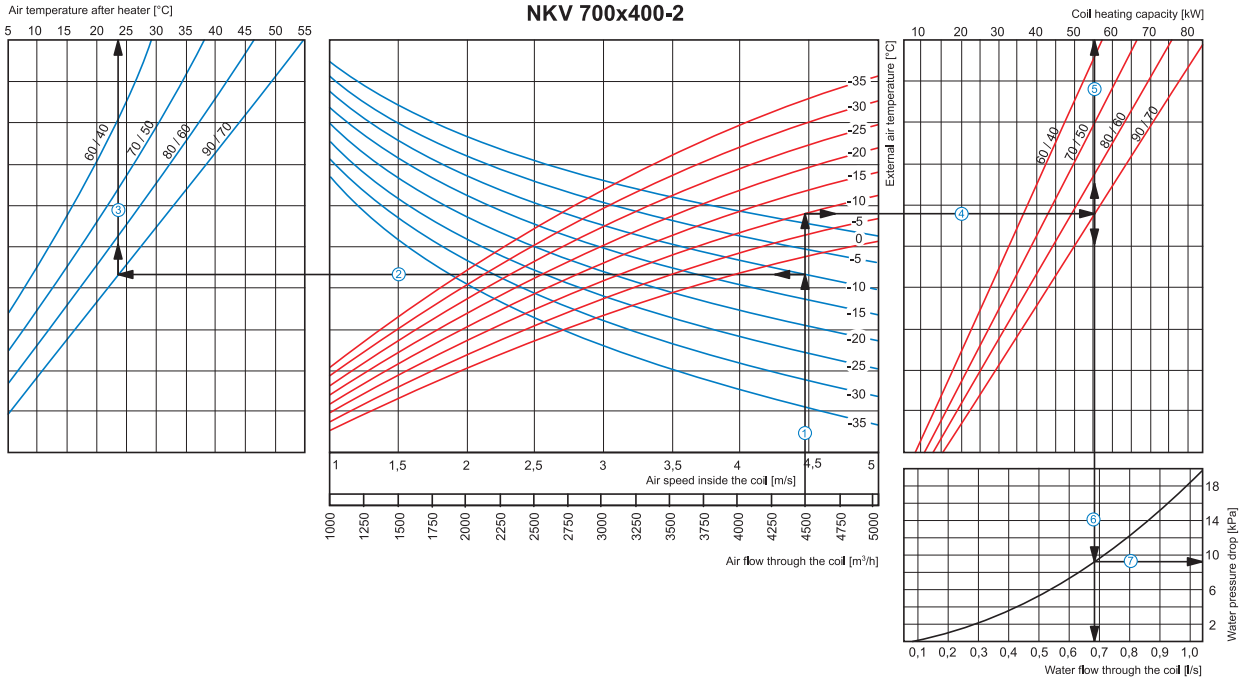

How to use water heater diagrams

Air Speed. Starting from 4500 m³/h on the air flow scale draw a vertical line ① till the air speed axis which makes about 4.45 m/s.

■ **Supply air temperature.** Prolong the line ① up to the point where it crosses the outside air temperature (blue curve), e.g. -10 °C; then draw a horizontal line ② from this point to the left till crossing water in/out temperature curve (90/70 °C). From this point draw a vertical line ③ to the supply air temperature axis on top of the graphic (+24 °C).

■ **Heating coil capacity.** Prolong the line ① up to the point where it crosses the outside air temperature indicated as red curve (e.g., -10 °C) and draw a horizontal line ④ from this point to the right to the intersection of water in/out temperature curve (e.g., 90/70 °C). From this point draw a vertical line ⑤ up to the scale of heating coil capacity (55.0 kW).

■ **Water flow.** Prolong the line ⑤ down to water flow axis at the bottom of the graphic ⑥ (0.68 l/s).

■ **Water pressure drop.** Draw the line ⑦ from the point where line ⑥ crosses the black curve to the pressure drop axis. (9.2 kPa).

NKV

NKV 700x400-3

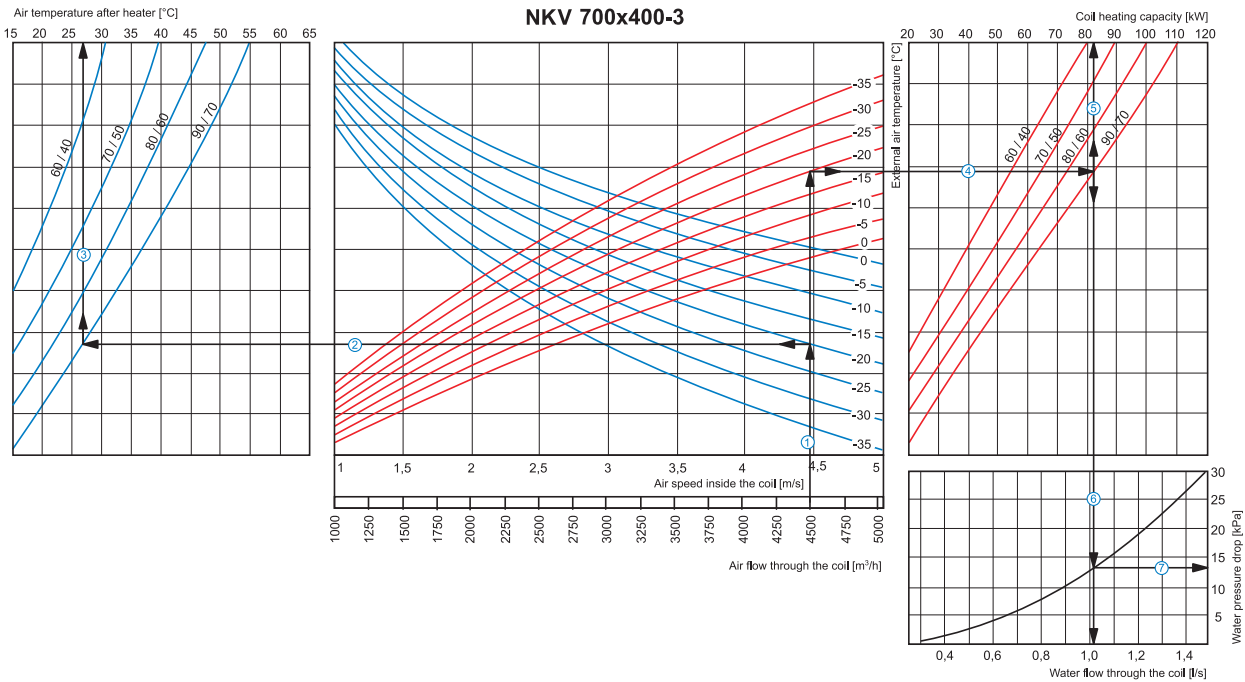

How to use water heater diagrams

Air Speed. Starting from 4500 m³/h on the air flow scale draw a vertical line ① till the air speed axis which makes about 4.45 m/s.

■ **Supply air temperature.** Prolong the line ① up to the point where it crosses the outside air temperature (blue curve), e.g. -20 °C; then draw a horizontal line ② from this point to the left till crossing water in/out temperature curve (90/70 °C). From this point draw a vertical line ③ to the supply air temperature axis on top of the graphic (+27 °C).

■ **Heating coil capacity.** Prolong the line ① up to the point where it crosses the outside air temperature indicated as red curve (e.g., -20 °C) and draw a horizontal line ④ from this point to the right to the intersection of water in/out temperature curve (e.g., 90/70 °C). From this point draw a vertical line ⑤ up to the scale of heating coil capacity (82.0 kW).

■ **Water flow.** Prolong the line ⑤ down to water flow axis at the bottom of the graphic ⑥ (1.02 l/s).

■ **Water pressure drop.** Draw the line ⑦ from the point where line ⑥ crosses the black curve to the pressure drop axis. (13.0 kPa).

NKV

NKV 800x500-2

Air temperature after heater [°C]
5 10 15 20 25 30 35 40 45 50 55

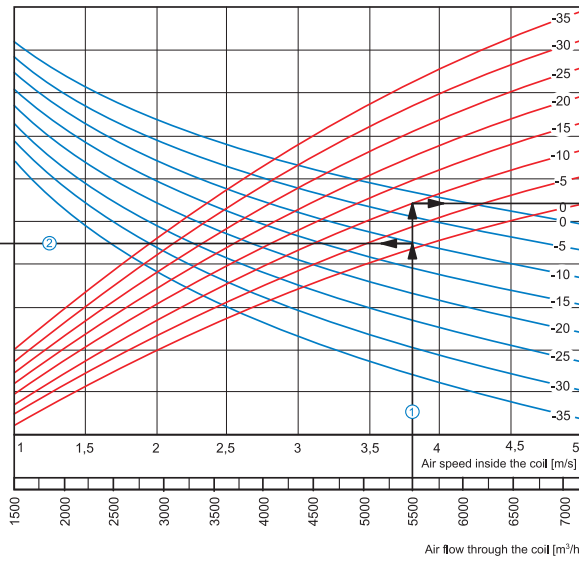
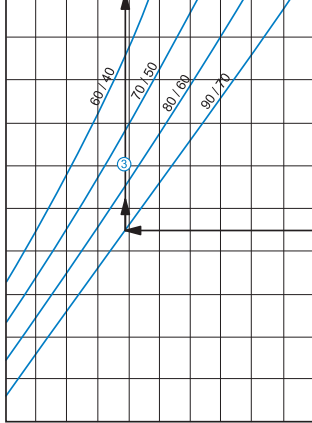

Coil heating capacity [kW]
10 20 30 40 50 60 70 80 90 100 110

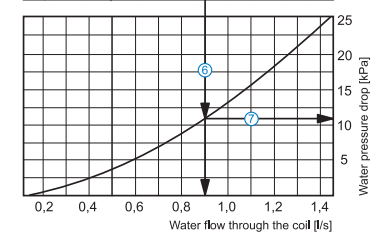
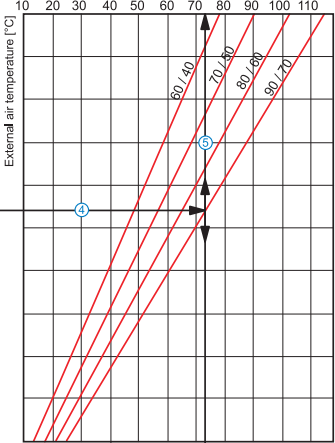

How to use water heater diagrams

Air Speed. Starting from 5500 m³/h on the air flow scale draw a vertical line ① till the air speed axis. It makes 3.8 m/s.

Supply air temperature. Prolong the line ① up to the point where it crosses the outside air temperature (blue curve), e.g. -10 °C; then draw a horizontal line ② from this point to the left till crossing water in/out temperature curve (90/70 °C). From this point draw a vertical line ③ to the supply air temperature axis on top of the graphic (+24.5 °C).

Heating coil capacity. Prolong the line ① up to the point where it crosses the outside air temperature indicated as red curve (e.g., -10 °C) and draw a horizontal line ④ from this point to the right to the intersection of water in/out temperature curve (e.g., 90/70 °C). From this point draw a vertical line ⑤ up to the scale of heating coil capacity (73.0 kW).

Water flow. Prolong the line ⑤ down to water flow axis at the bottom of the graphic ⑥ (0.9 l/s).

Water pressure drop. Draw the line ⑦ from the point where line ⑥ crosses the black curve to the pressure drop axis. (11.0 kPa).

NKV

NKV 800x500-3

Air temperature after heater [°C]
15 20 25 30 35 40 45 50 55 60 65

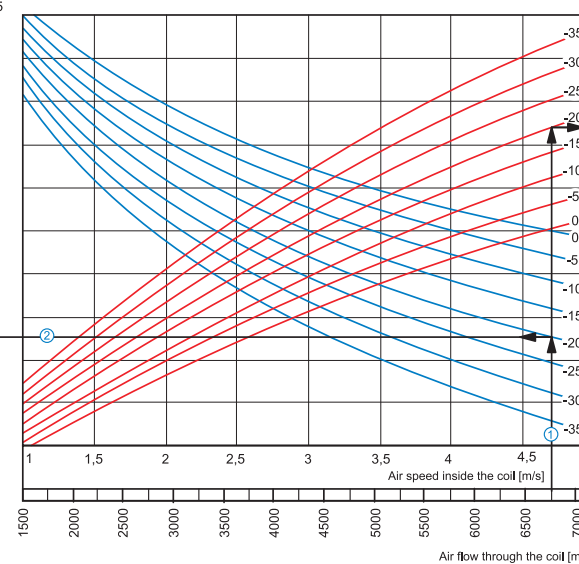
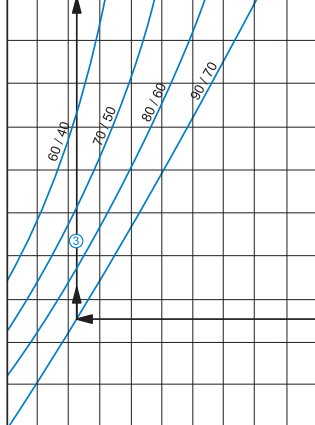

Coil heating capacity [kW]
40 60 80 100 120 140 160

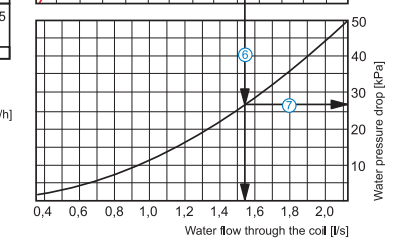
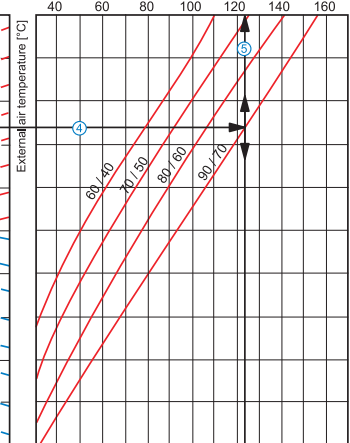

How to use water heater diagrams

Air Speed. Starting from 6750 m³/h on the air flow scale draw a vertical line ① till the air speed axis. It makes 4.7 m/s.

Supply air temperature. Prolong the line ① up to the point where it crosses the outside air temperature (blue curve), e.g. -20 °C; then draw a horizontal line ② from this point to the left till crossing water in/out temperature curve (90/70 °C). From this point draw a vertical line ③ to the supply air temperature axis on top of the graphic (+26 °C).

Heating coil capacity. Prolong the line ① up to the point where it crosses the outside air temperature indicated as red curve (e.g., -20 °C) and draw a horizontal line ④ from this point to the right to the intersection of water in/out temperature curve (e.g., 90/70 °C). From this point draw a vertical line ⑤ up to the scale of heating coil capacity (123.0 kW).

Water flow. Prolong the line ⑤ down to water flow axis at the bottom of the graphic ⑥ (1.54 l/s).

Water pressure drop. Draw the line ⑦ from the point where line ⑥ crosses the black curve to the pressure drop axis. (27.0 kPa).

NKV

Air temperature after heater [°C]

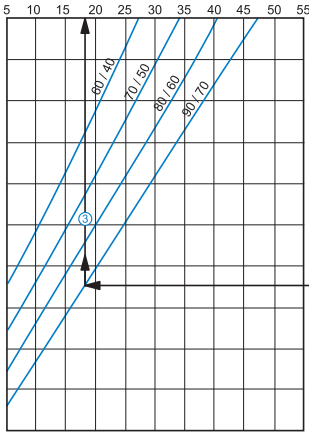

NKV 900x500-2

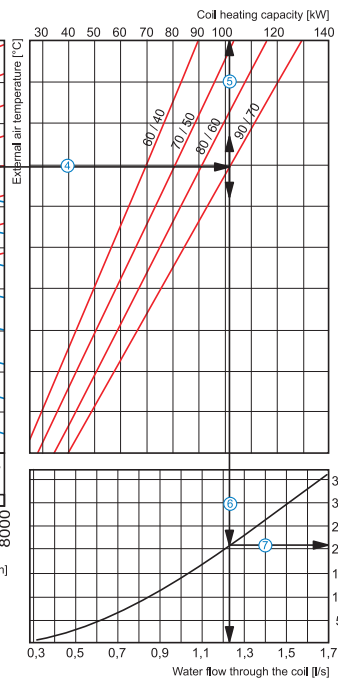
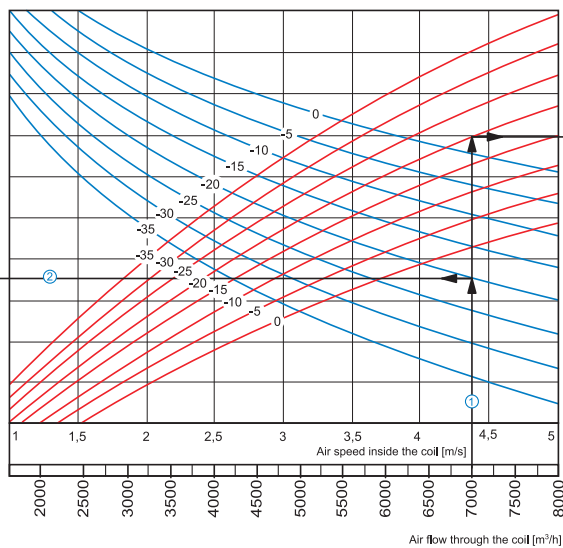

How to use water heating coils diagrams

Air Speed. Starting from 7000 m³/h on the air flow scale draw a vertical line ① till the air speed axis. It makes 4.4 m/s.

Supply air temperature. Prolong the line ① up to the point where it crosses the outside air temperature (blue curve), e.g. -20 °C; then draw a horizontal line ② from this point to the left till crossing water in/out temperature curve (90/70 °C). From this point draw a vertical line ③ to the supply air temperature axis on top of the graphic (+18 °C).

Heating coil capacity. Prolong the line ① up to the point where it crosses the outside air temperature indicated as red curve (e.g., -20 °C) and draw a horizontal line ④ from this point to the right to the intersection of water in/out temperature curve (e.g., 90/70 °C). From this point draw a vertical line ⑤ up to the scale of heating coil capacity (102.0 kW).

Water flow. Prolong the line ⑤ down to water flow axis at the bottom of the graphic ⑥ (1.23 l/s).

Water pressure drop. Draw the line ⑦ from the point where line ⑥ crosses the black curve to the pressure drop axis. (21.0 kPa).

NKV

Air temperature after heater [°C]

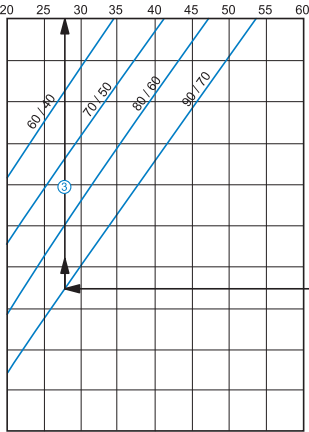

NKV 900x500-3

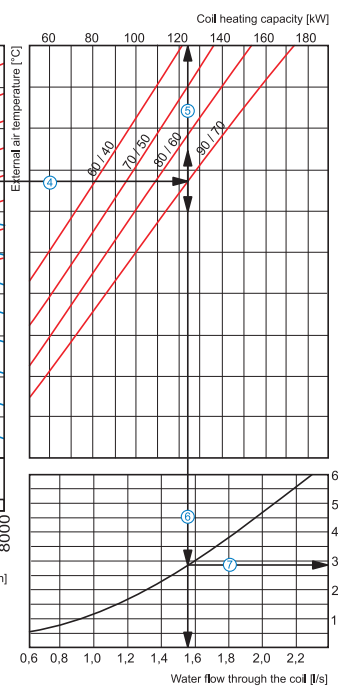
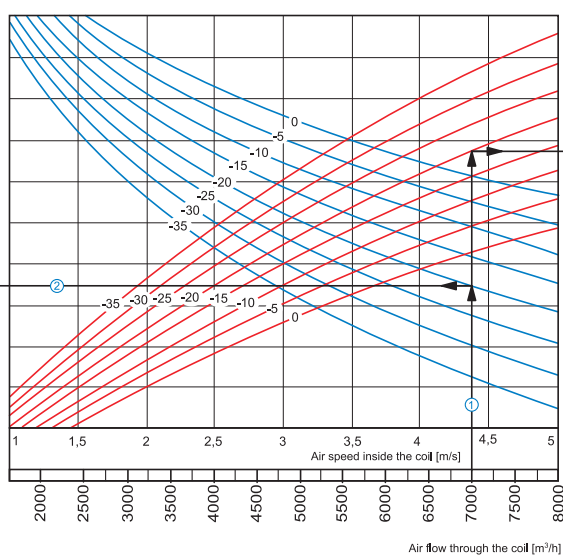

How to use water heater diagrams

Air Speed. Starting from 7000 m³/h on the air flow scale draw a vertical line ① till the air speed axis. It makes 4.4 m/s.

Supply air temperature. Prolong the line ① up to the point where it crosses the outside air temperature (blue curve), e.g. -20 °C; then draw a horizontal line ② from this point to the left till crossing water in/out temperature curve (90/70 °C). From this point draw a vertical line ③ to the supply air temperature axis on top of the graphic (+28 °C).

Heating coil capacity. Prolong the line ① up to the point where it crosses the outside air temperature indicated as red curve (e.g., -20 °C) and draw a horizontal line ④ from this point to the right to the intersection of water in/out temperature curve (e.g., 90/70 °C). From this point draw a vertical line ⑤ up to the scale of heating coil capacity (124.0 kW).

Water flow. Prolong the line ⑤ down to water flow axis at the bottom of the graphic ⑥ (1.55 l/s).

Water pressure drop. Draw the line ⑦ from the point where line ⑥ crosses the black curve to the pressure drop axis. (28.0 kPa).

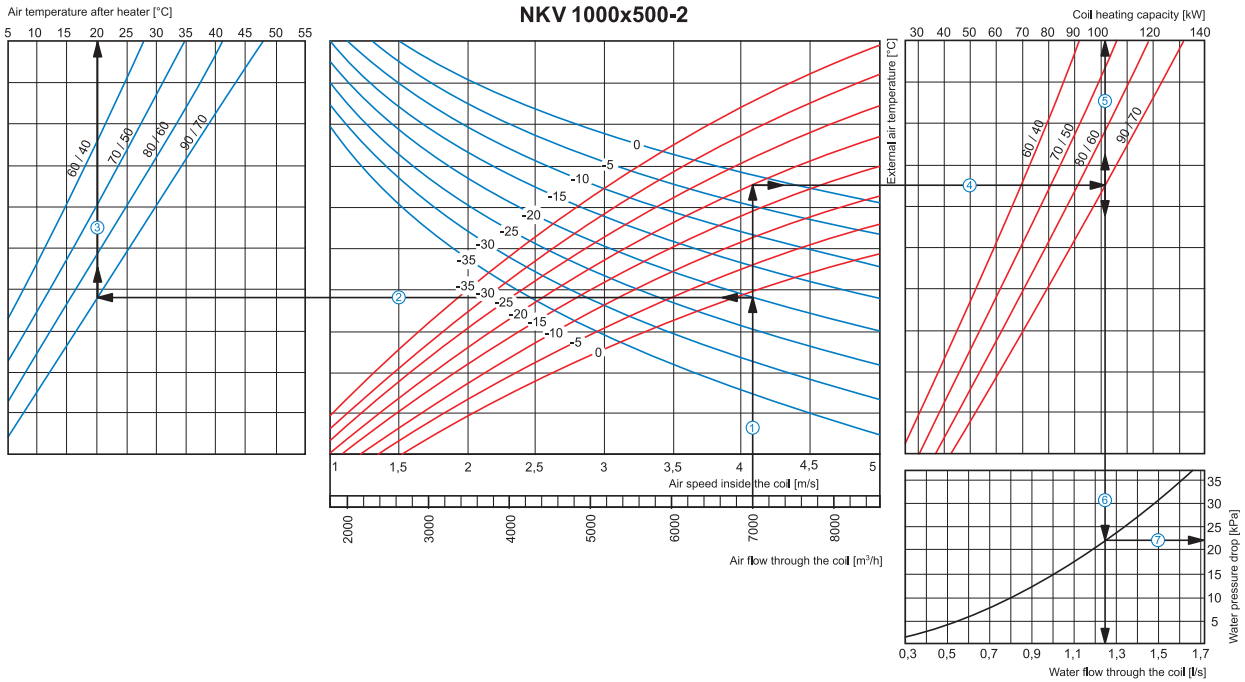

How to use water heater diagrams

Air Speed. Starting from 7000 m³/h on the air flow scale draw a vertical line ① till the air speed axis. It makes 4.1 m/s.

■ **Supply air temperature.** Prolong the line ① up to the point where it crosses the outside air temperature (blue curve), e.g. -20 °C; then draw a horizontal line ② from this point to the left till crossing water in/out temperature curve (90/70 °C). From this point draw a vertical line ③ to the supply air temperature axis on top of the graphic (+20 °C).

■ **Heating coil capacity.** Prolong the line ① up to the point where it crosses the outside air temperature indicated as red curve (e.g., -20 °C) and draw a horizontal line ④ from this point to the right to the intersection of water in/out temperature curve (e.g., 90/70 °C). From this point draw a vertical line ⑤ up to the scale of heating coil capacity (101.0 kW).

■ **Water flow.** Prolong the line ⑤ down to water flow axis at the bottom of the graphic ⑥ (1.25 l/s).

■ **Water pressure drop.** Draw the line ⑦ from the point where line ⑥ crosses the black curve to the pressure drop axis. (22.0 kPa).

NKV

NKV 1000x500-3

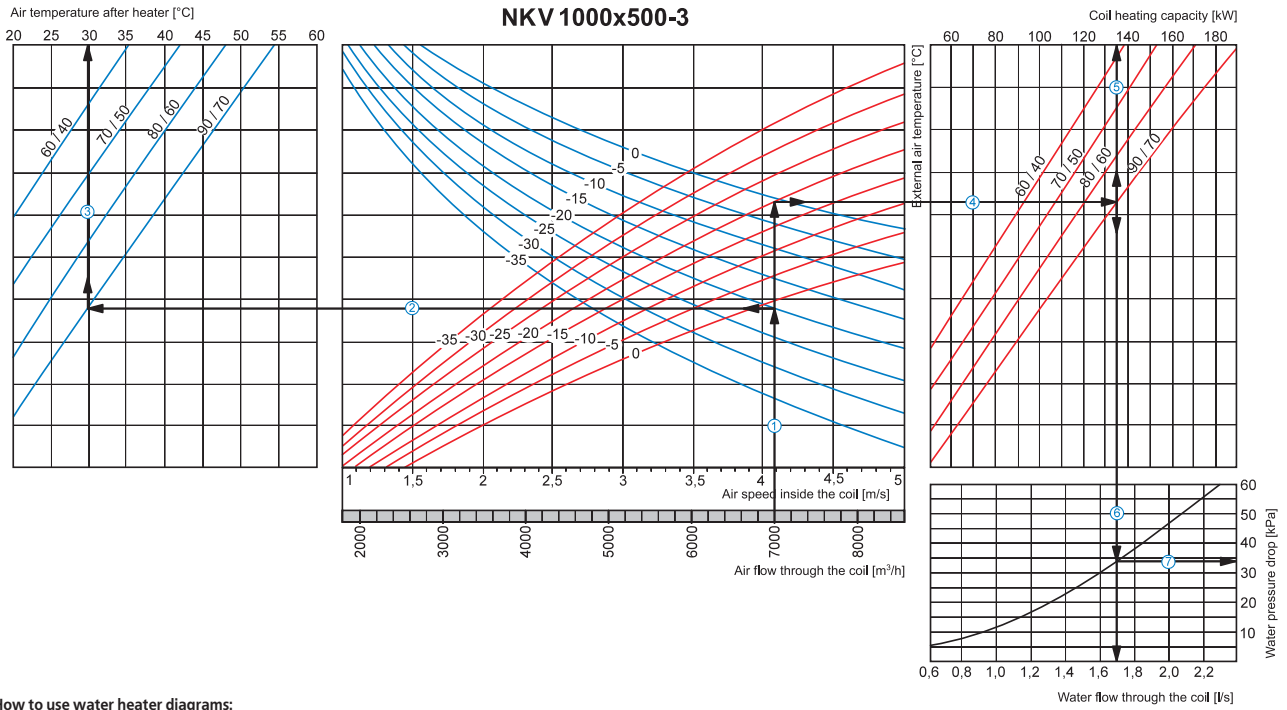

How to use water heater diagrams:

Air Speed. Starting from 7000 m³/h on the air flow scale draw a vertical line ① till the air speed axis. It makes 4.1 m/s.

Supply air temperature. Prolong the line ① up to the point where it crosses the outside air temperature (blue curve), e.g. -20 °C; then draw a horizontal line ② from this point to the left till crossing water in/out temperature curve (90/70 °C). From this point draw a vertical line ③ to the supply air temperature axis on top of the graphic (+30 °C).

Heating coil capacity. Prolong the line ① up to the point where it crosses the outside air temperature indicated as red curve (e.g., -20 °C) and draw a horizontal line ④ from this point to the right to the intersection of water in/out temperature curve (e.g., 90/70 °C). From this point draw a vertical line ⑤ up to the scale of heating coil capacity (135.0 kW).

Water flow. Prolong the line ⑤ down to water flow axis at the bottom of the graphic ⑥ (1.7 l/s).

Water pressure drop. Draw the line ⑦ from the point where line ⑥ crosses the black curve to the pressure drop axis. (34.0 kPa).

Series
USWK



■ **Application**

The mixing unit USWK is designed for smooth heat medium flow control in ventilation systems equipped with water heaters or coolers for supply air temperature regulation. The mixing unit controls heat medium flow supplied to the water heat exchanger and in such a way maintains the supply air temperature. The mixing unit USWK is compatible with NKV water heaters, duct coolers OKW as well as all water heat exchangers (both heaters and coolers) integrated into air handling units.

■ **Design and operating logic**

Design of the mixing unit USWK is shown in fig. 1. The circulation pump (1) of the mixing unit ensures ongoing heat medium circulation through the water heat exchanger. The heat medium regulating three-way valve (3) with electric actuator (2) is installed before the circulation pump to mix the water supplied from the heating (cooling) system with the return water supplied through the recirculation pipe (4). The three-way valve is designed to provide the mixing ratio of two water streams and thus to control the heat medium temperature supplied to the water heat exchanger. The three-way valve actuator is controlled by 0-10 V output signal from the ventilation control system.

■ **Connection to water mains**

The mixing unit is connected directly to the water heat exchanger and water mains through rigid and/or flexible pipes.

In case of flexible pipe connection, fix the mixing unit firmly to the wall or another rigid surface with clamps. While installing the mixing unit keep the motor horizontal position to disable any distortions and mechanical loads from the connected pipelines to USWK unit. While connecting the mixing unit to water mains make sure of no loads and distortions that may damage the unit structure and provoke USWK airtightness breach. While connecting the pipelines

ensure their quick detachment for scheduled servicing and maintenance operations.

■ **Electric connection**

All electric installations are allowed by qualified electricians with valid permit for electric operations. Before connecting the pump make sure to have grounded it. Make steps to prevent contact with power cables.

■ **Operating conditions**

The pump motor bearings are greased by the pumped medium. The single phase pumps do not require extra overload protection and the three phase pumps must be provided with external overload protection. The maximum allowable heat medium pressure in the unit is 10 bar.

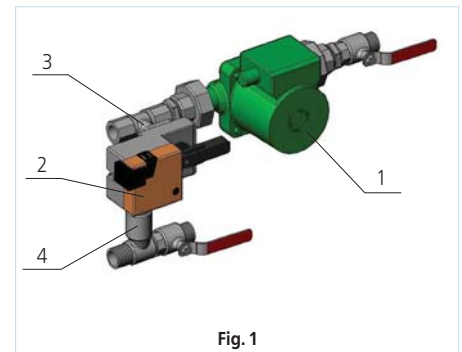
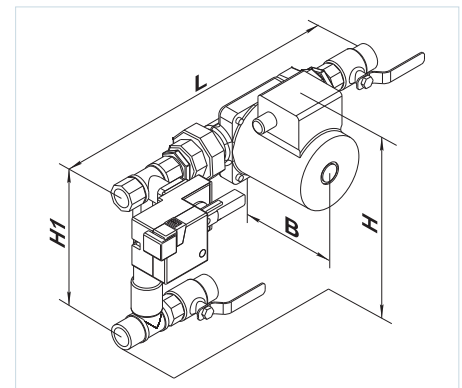

Fig. 1

Overall dimensions:

Type	Dimensions [mm]				Weight [kg]
	B	H	H1	L	
USWK 3/4-4	150	290	180	460	4.1
USWK 3/4-6	150	290	180	460	4.1
USWK 1-6	175	320	210	490	6.8
USWK 1-10	175	320	210	490	6.8
USWK 1 1/4-10	175	355	240	500	7.4
USWK 1 1/4-16	175	355	240	500	7.4
USWK 1 1/2-16	266	420	255	610	23.0
USWK 1 1/2-25	266	420	255	610	23.0
USWK 2-25	312	474	290	660	31.0
USWK 2-40	312	474	290	660	31.0



Δp_{v100} – pressure loss at fully opened valve;

*3-way valve $K_{vs} = \frac{V_{100}}{\sqrt{\frac{\Delta p_{v100}}{100}}}$, where V_{100} – rated water flow at Δp_{v100} .

Designation key:

Series	Connecting diameter	3-way valve [Kvs]*
USWK	3/4"; 1"; 1 1/4"; 1 1/2"; 2"	4; 6; 10; 16; 25; 40

Technical data:

	value	USWK 3/4-4	USWK 3/4-6	USWK 1-6	USWK 1-10	USWK 1 1/4-10	USWK 1 1/4-16	USWK 1 1/2-16	USWK 1 1/2-25	USWK 2-25	USWK 2-40
Circulation pump	-	DAB VA65/180		DAB A50/180XM		DAB A56/180XM		DAB BPH 120/250.40M		DAB BPH 120/280.50T	
Three-way valve regulation mode	-	smooth 0...10 V									
Three-way valve with electric actuator	-	Belimo R317	Belimo R318	Belimo R322	Belimo R323	Belimo R329	Belimo R331	Belimo R338	Belimo R339G	Belimo R348	Belimo R349G
Three-way valve actuator	-	Belimo LR24A-SR						Belimo NR24A-SR	Belimo SR24A-SR	Belimo NR24A-SR	Belimo SR24A-SR
Connection	-	Thread						Flange			
Three-way valve nominal diameter	-	DN 20	DN 20	DN 25	DN 25	DN 32	DN 32	DN 40	DN 40	DN 50	DN 50
Three-way valve K_{vs}	-	4	6.3	6.3	10	10	16	16	25	25	40
Max. capacity	m ³ /h	2.3	3.0	4.1	6.0	6.8	9.0	11.0	14.0	21.0	27.0
Max. developed head	kPa	57	57	57	57	62	62	110	110	115	115
Connecting pipe diameter	inch	3/4"	3/4"	1"	1"	1 1/4"	1 1/4"	1 1/2"	1 1/2"	2"	2"
Pumped medium temperature	°C	-10...+110						-10...+120			
Max. glycol content in pumped medium	%	30	30	30	30	30	30	30	30	30	30
Number of pump speeds	-	3	3	3	3	3	3	3	3	3	3
Phase/ Pump voltage	V	1 ~ 230								3 ~ 400	
Max. pump power	W	78	78	184	184	271	271	510	510	898	898

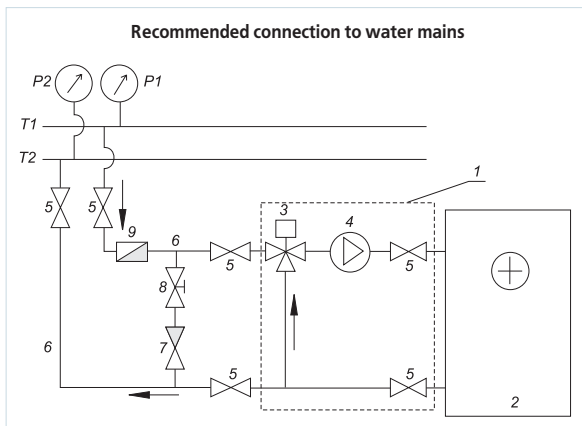

T1 and T2 – supply and return pipeline;
 P1 and P2 – manometers for supply and return pipelines in the water mains;

- 1 – USWK (mixing unit);
- 2 – Water heater;
- 3 – Three-way valve with actuator;
- 4 – Circulation pump;
- 5 – Shutoff valve;
- 6 – Supply and return pipeline from water mains to the water heater;
- 7 – Non-return valve;
- 8 – Balancing valve;
- 9 – Coarse filter.

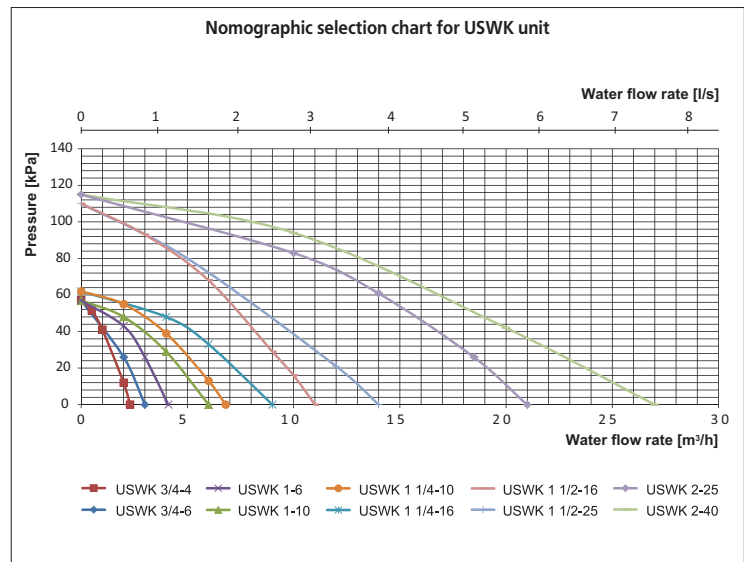

To select the mixing unit according to the nomographic chart, calculate the required heat medium flow through the water heat exchanger and water pressure drop (water head). These parameters are calculated according to the heating/cooling diagrams specifically for each water heat exchanger stated specifically herein.

Series
RRV



■ **Application**

Multi-blade damper for air flow control or cut-off in rectangular air ducts.

Compatible with duct sizes 400x200, 500x250, 500x300, 600x300, 600x350, 700x400, 800x500, 900x500 and 1000x500 mm.

■ **Design**

The housing made of galvanized steel. The aluminium blades driven by plastic gearwheels. Lever with removable metal handle and fixing clamp.

Universal shaft for automatic actuator. Compatible actuators are shown in the table below (available upon separate order). For actuator connection the metal handle should be removed from the shaft.

■ **Mounting**

Standard connection flange for rectangular air ducts or other ventilation system components.

Flanges should be connected with galvanized bolts and clamps.

Overall dimensions:

Type	Dimensions [mm]								Weight [kg]
	B	B1	B2	B3	H	H1	H2	L	
RRV 400x200	400	420	440	540	200	220	240	170	3.5
RRV 500x250	500	520	540	640	250	270	290	170	4.2
RRV 500x300	500	520	540	640	300	320	340	170	4.9
RRV 600x300	600	620	640	740	300	320	340	170	5.4
RRV 600x350	600	620	640	740	350	370	390	170	5.7
RRV 700x400	700	720	740	840	400	420	440	170	7.7
RRV 800x500	800	820	840	940	500	520	540	170	8.8
RRV 900x500	900	920	940	1040	500	520	540	170	9.6
RRV 1000x500	1000	1020	1040	1140	500	520	540	170	10.3

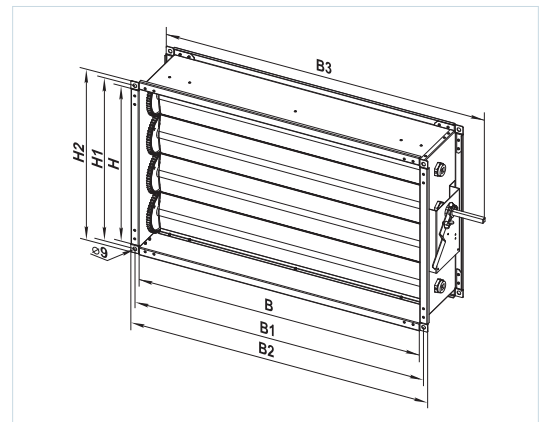

Compatible Belimo actuators:

Model	Actuator type			
	Electric actuator, 230 V	Spring return electric actuator, 230 V	Electric actuator, 24 V	Spring return electric actuator, 24 V
RRV 400x200				
RRV 500x250				
RRV 500x300	CM230 / LM230A	TF230 / LF230	CM24 / LM24A	TF24 / LF24
RRV 600x300				
RRV 600x350				
RRV 700x400				
RRV 800x500				
RRV 900x500	LM230A	LF230	LM24A	LF24
RRV 1000x500				

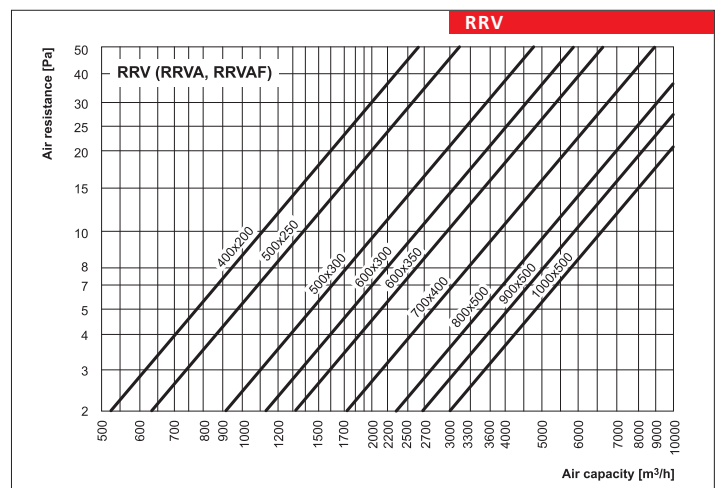

Designation key:

Series	Flange dimensions [mm]
RRV	400x200; 500x250; 500x300; 600x300; 600x350; 700x400; 800x500; 900x500; 1000x500

Accessories



page 107



page 108



page 109



page 110

MIXING CHAMBERS

Series
SKRA



■ Applications

The mixing chambers is designed for mixing (recirculation) of extract and intake air in a required ratio.

■ Design

The housing made of galvanized steel. The dampers with aluminium blades driven by plastic gear-wheels.

Extract and supply air dampers are interconnected with one shaft and are opened synchronously with a single actuator. The recirculation damper is opened by a separate actuator.

SKRA is equipped with two 24 V actuators for air flow control. Both actuators are driven by 0-10 V input voltage from 100% recirculation to 100% fresh air.

■ Mounting

Standard connection flange for rectangular air ducts or other ventilation system components.

Fixation with galvanized bolts and clamps. The mixing units are suitable both for indoor and outdoor installation in any operating position. Service access to the actuators must be provided.

Overall dimensions:

Type	Dimensions [mm]								Weight [kg]
	B	B1	B2	B3	H	H1	H2	L	
SKRA 400x200/24	400	420	940	960	200	220	240	390	20
SKRA 500x250/24	500	520	1140	1160	250	270	290	440	25
SKRA 500x300/24	500	520	1140	1160	300	320	340	490	33
SKRA 600x300/24	600	620	1340	1360	300	320	340	490	36
SKRA 600x350/24	600	620	1340	1360	350	370	390	540	40
SKRA 700x400/24	700	720	1540	1560	400	420	440	590	45
SKRA 800x500/24	800	820	1740	1760	500	520	540	690	55
SKRA 900x500/24	900	920	1940	1960	500	520	540	740	60
SKRA 1000x500/24	1000	1020	2140	2160	500	520	540	740	65

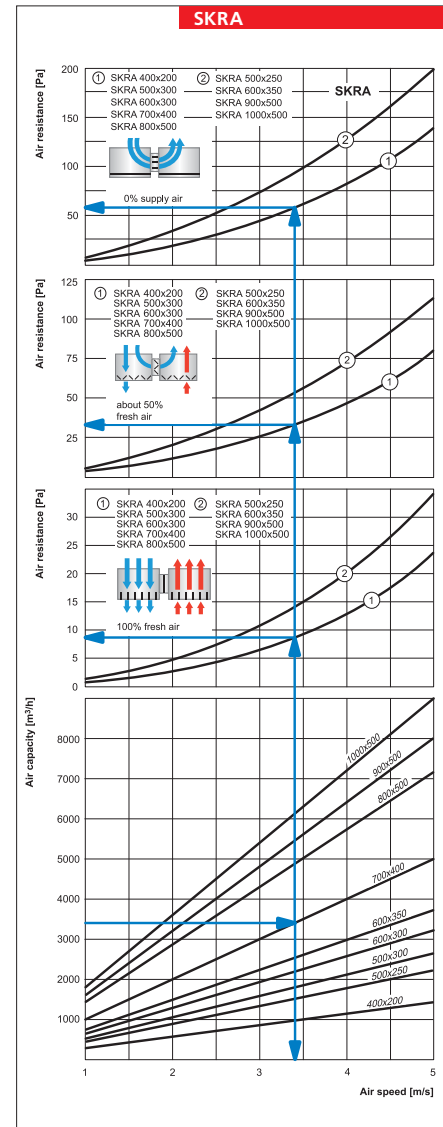
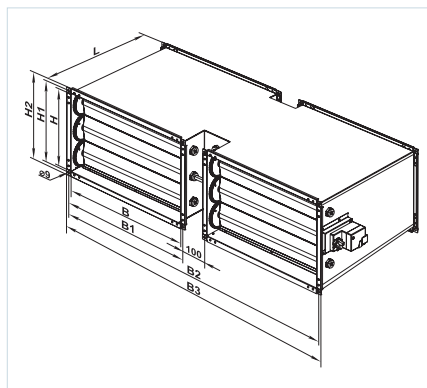

Designation key:

Series	Flange dimensions [mm]	Automatic actuator power supply voltage, V
SKRA	400x200; 500x250; 500x300; 600x300; 600x350; 700x400; 800x500; 900x500; 1000x500	24

**Series
OKW**



**Series
OKW1**



Applications

Duct water coil air coolers are designed for cooling of supply air in rectangular ventilation systems and can be applied in supply or supply and exhaust ventilation systems.

Design

The water coolers are available in OKW and OKW1 modifications. The OKW1 cooler has a simplified design. The cooler casing is made of galvanized steel, the manifold is made of copper tubes and the heat exchange surface is made of aluminium plates. The cooling coils are available in 3 rows modification and designed for the maximum operating pressure 1.5 MPa (15 bar). It is equipped with a droplet separator and a drain pan for condensate collection and removal.

For OKW and OKW1 models by default the service side is located on the right side from the air stream direction. The OKW cooler service side location can be changed by coil turning by 180°. The OKW1 modification does not have this option.

Mounting

Mounting is effected by means of flange connection. The water cooling coils can be installed only horizontally to enable the unit deaeration and

condensate draining.

- ▶ The installation shall be performed in such a way as to enable the uniform air distribution along the entire cross section.
- ▶ The air filter shall be installed at the cooler inlet to protect the cooler against dirt and dusting.
- ▶ The cooler can be installed both at the fan inlet or outlet. If the cooling coils are located at the fan outlet the air duct between the cooler and the fan shall have the length 1 to 1.5 m to ensure the air flow stabilization.
- ▶ To attain the maximum cooling capacity the cooler must be connected on counter-flow basis. All the nomographic charts in the catalogue are valid for such connection.
- ▶ If water serves as a cooling agent, the coolers are

suitable for indoor installation only in the premises with the indoor temperature not below 0 °C. For outdoor installation use an antifreeze mixture, i.e.ethylene glycol solution.

- ▶ The droplet separator is made of polypropylene profile and prevents condensate dripping from the cooling tubes by the cooling air flow. While selecting a cooler type consider that the most suitable speed of the air flow for the efficient droplet separator operation is up to 4 m/s.
- ▶ Condensate drain from the cooler shall be performed through the U-trap. The U-trap height depends on the total pressure in the fan and can be calculated using the figures and the table below.

H [mm]	K [mm]	P [Pa]
100	55	600
200	105	1100
260	140	1400

H – U-trap height
K – drain height
P – total pressure in the fan

- ▶ To ensure the correct and safe cooler operation use the automation system providing the complex control and automatic regulation of the cooling capacity and air cooling temperature.

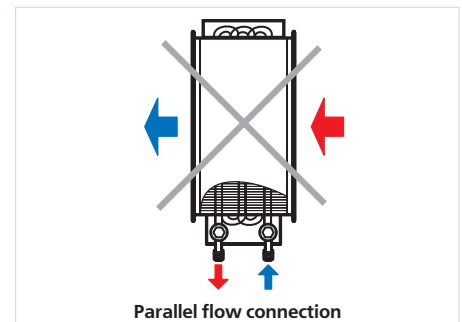
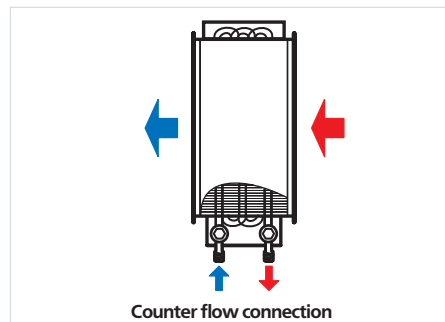

Designation key:

Series	Flange dimensions (WxH) [mm]	Number of cooling coils
OKW / OKW1	400x200; 500x250; 500x300; 600x300; 600x350; 700x400; 800x500; 900x500; 1000x500	3

Accessories



page 60

Overall dimensions:

Type	Dimensions [mm]										
	B	B1	B2	B3	H	H1	H2	H3	H4	L	K (inch)
OKW 400x200-3	400	420	440	470	200	220	240	295	124	56	G 3/4"
OKW 500x250-3	500	520	540	570	250	270	290	345	188	45	G 3/4"
OKW 500x300-3	500	520	540	570	300	320	340	395	252	56	G 3/4"
OKW 600x300-3	600	620	640	670	300	320	340	395	252	56	G 3/4"
OKW 600x350-3	600	620	640	670	350	370	390	445	268	56	G 3/4"
OKW 700x400-3	700	720	740	770	400	420	440	495	314	56	G 3/4"
OKW 800x500-3	800	820	840	870	500	520	540	595	442	56	G 3/4"
OKW 900x500-3	900	920	940	970	500	520	540	595	442	56	G 3/4"
OKW 1000x500-3	1000	1020	1040	1070	500	520	540	595	442	56	G 1"

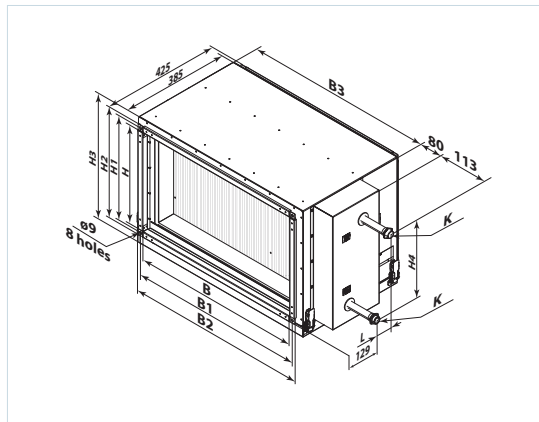

Overall dimensions:

Type	Dimensions [mm]										
	B	B1	B2	H	H1	H2	H3	H4	L	K (inch)	
OKW1 400x200-3	400	420	580	200	220	270	124	70	56	G 3/4"	
OKW1 500x250-3	500	520	680	250	270	320	188	102	45	G 3/4"	
OKW1 500x300-3	500	520	680	300	320	370	252	70	56	G 3/4"	
OKW1 600x300-3	600	620	780	300	320	370	252	134	56	G 3/4"	
OKW1 600x350-3	600	620	780	350	370	420	268	229	56	G 3/4"	
OKW1 700x400-3	700	720	880	400	420	470	314	196	56	G 3/4"	
OKW1 800x500-3	800	820	980	500	520	570	442	324	56	G 3/4"	
OKW1 900x500-3	900	920	1080	500	520	570	442	324	56	G 3/4"	
OKW1 1000x500-3	1000	1020	1180	500	520	570	442	324	56	G 1"	

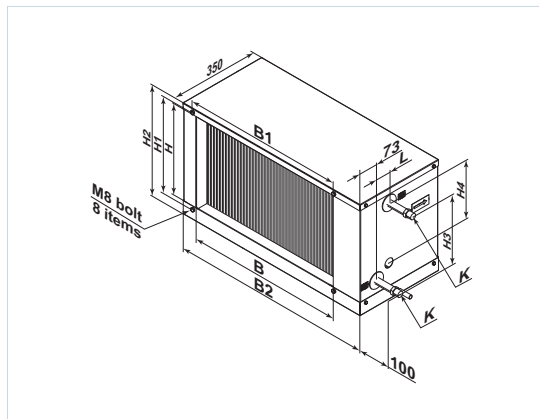

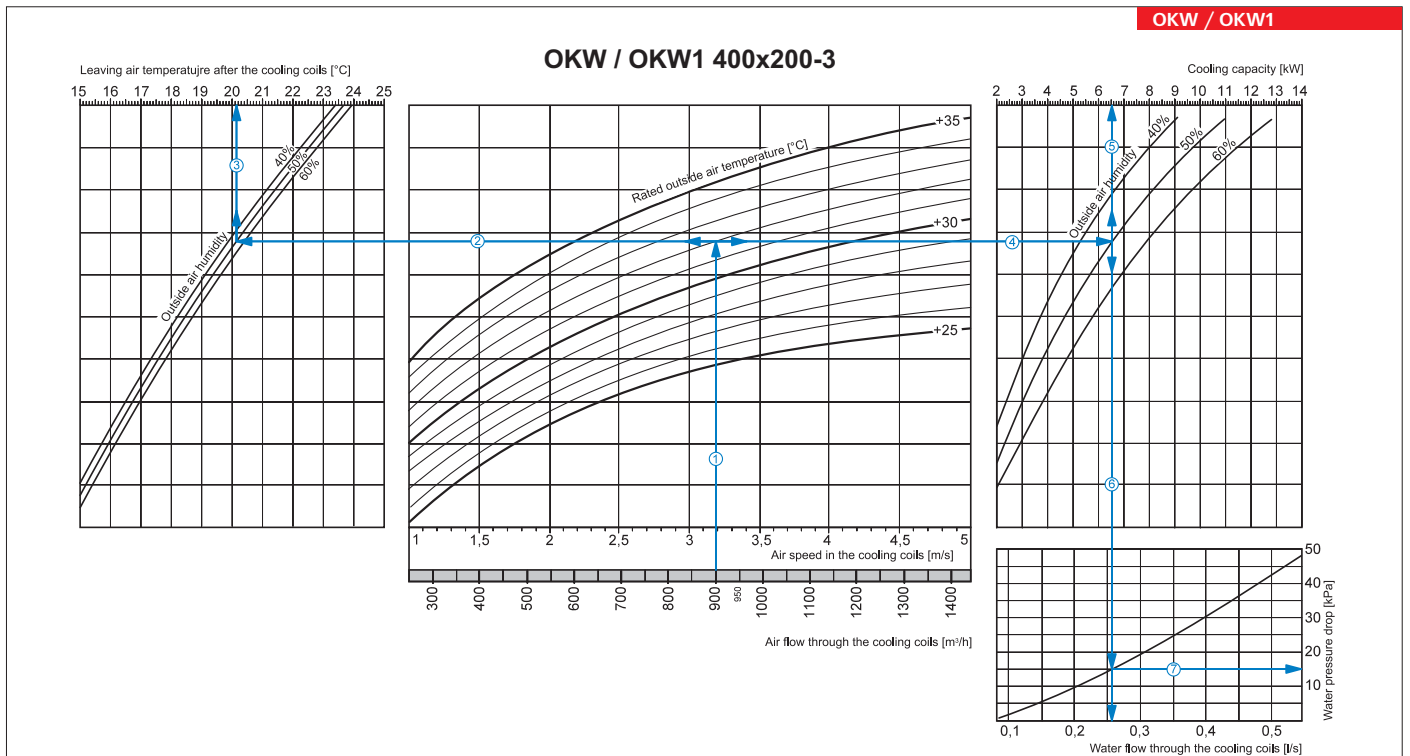
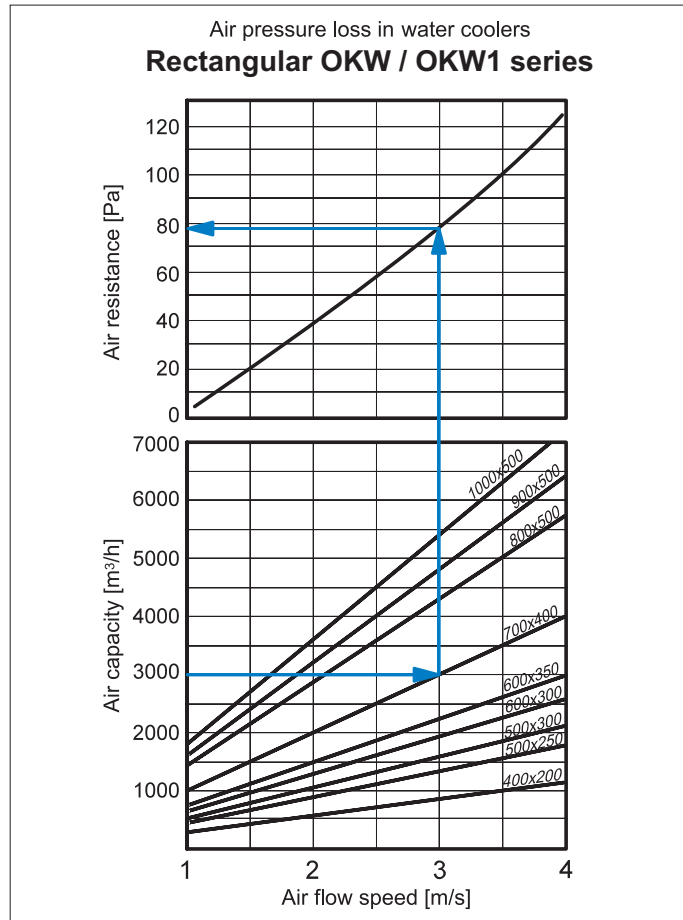

How to use water cooler diagrams

- Air Speed. Starting from 900 m³/h on the air flow scale draw a vertical line ① till the air speed axis. It makes 3.2 m/s.
- Supply air temperature. Prolong the line ① up to the point where it crosses the outside air temperature (e.g. +32 °C); then draw a horizontal line ② from this point to the left till crossing the outside air humidity (e.g. 50%). From this point draw a vertical line ③ to the supply air temperature at cooler outlet axis on top of the graphic (+20.1 °C).
- Cooling capacity. Prolong the line ① up to the point where it crosses the outside air temperature (e.g. +32 °C) and draw a horizontal line ④ from this point to the right until it crosses the outside air humidity curve (e.g., 50%), from here draw a vertical line ⑤ up to the scale representing the cooler capacity (6.5 kW).
- Water flow. Prolong the line ⑤ down to water flow axis at the bottom of the graphic ⑥ (0.26 l/s).
- Water pressure drop. Draw the line ⑦ from the point where the line ⑥ crosses the black curve to the pressure drop axis. (15.0 kPa).

OKW / OKW1

OKW / OKW1 500x250-3

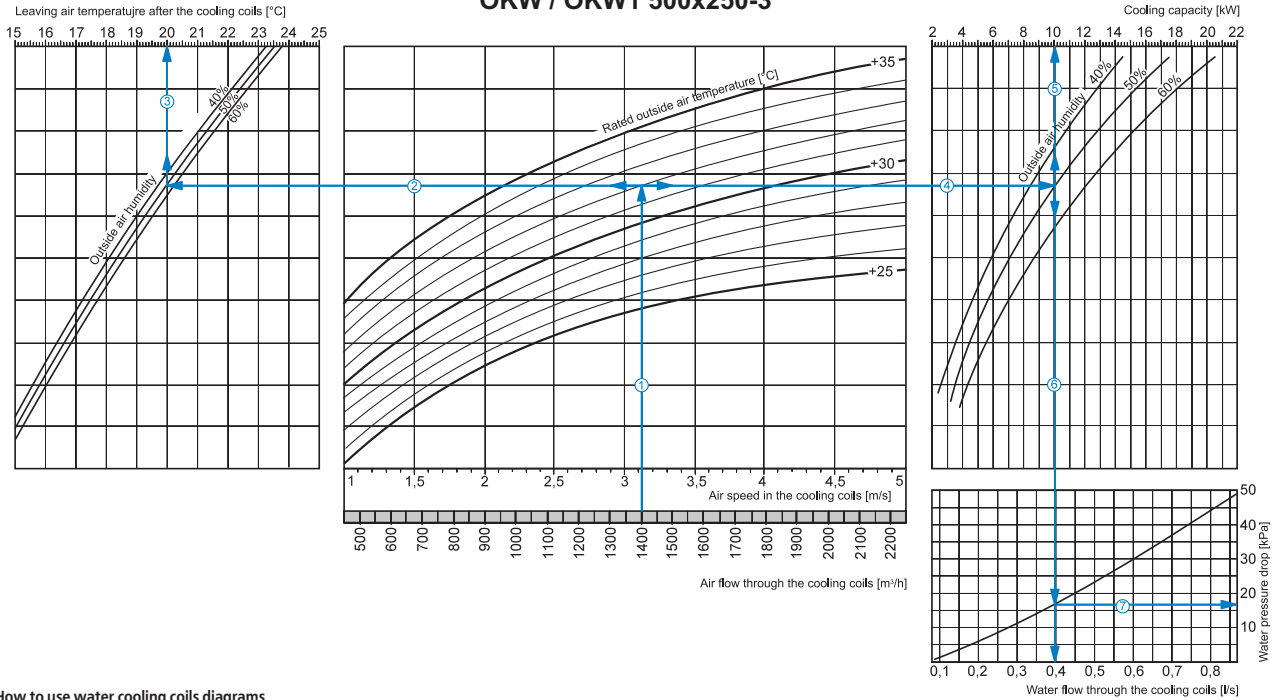

How to use water cooling coils diagrams

Air Speed. Starting from 1400 m³/h on the air flow scale draw a vertical line ① till the air speed axis. It makes 3.1 m/s.

Supply air temperature. Prolong the line ① up to the point where it crosses the outside air temperature (e.g. +32 °C); then draw a horizontal line ② from this point to the left till crossing the outside air humidity (e.g. 50%). From this point draw a vertical line ③ to the supply air temperature at cooler outlet axis on top of the graphic (+20 °C).

Cooling capacity. Prolong the line ① up to the point where it crosses the outside air temperature (e.g. +32 °C) and draw a horizontal line ④ from this point to the right until it crosses the outside air humidity curve (e.g., 50%), from here draw a vertical line ⑤ up to the scale representing the cooling capacity (10.0 kW).

Water flow. Prolong the line ⑤ down to water flow axis at the bottom of the graphic ⑥ (0.4 l/s).

Water pressure drop. Draw the line ⑦ from the point where the line ⑥ crosses the black curve to the pressure drop axis. (17.0 kPa).

OKW / OKW1

OKW / OKW1 500x300-3

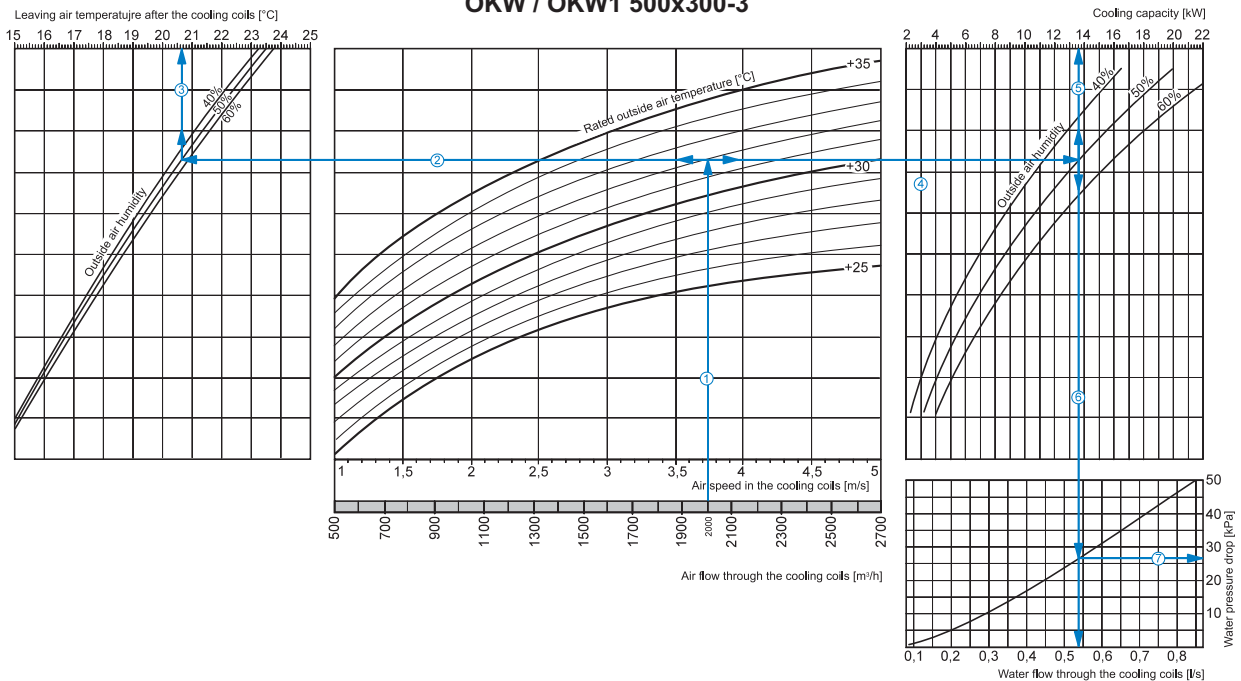

How to use water cooler diagrams

Air Speed. Starting from 2000 m³/h on the air flow scale draw a vertical line ① till the air speed axis. It makes 3.75 m/s.

Supply air temperature. Prolong the line ① up to the point where it crosses the outside air temperature (e.g. +32 °C); then draw a horizontal line ② from this point to the left till crossing the outside air humidity (e.g. 50%). From this point draw a vertical line ③ to the supply air temperature at cooler outlet axis on top of the graphic (+20.6 °C).

Cooling capacity. Prolong the line ① up to the point where it crosses the outside air temperature (e.g. +32 °C) and draw a horizontal line ④ from this point to the right until it crosses the outside air humidity curve (e.g., 50%), from here draw a vertical line ⑤ up to the scale representing the cooling capacity (13.6 kW).

Water flow. Prolong the line ⑤ down to water flow axis at the bottom of the graphic ⑥ (0.54 l/s).

Water pressure drop. Draw the line ⑦ from the point where the line ⑥ crosses the black curve to the pressure drop axis. (27.0 kPa).

OKW / OKW1 600x300-3

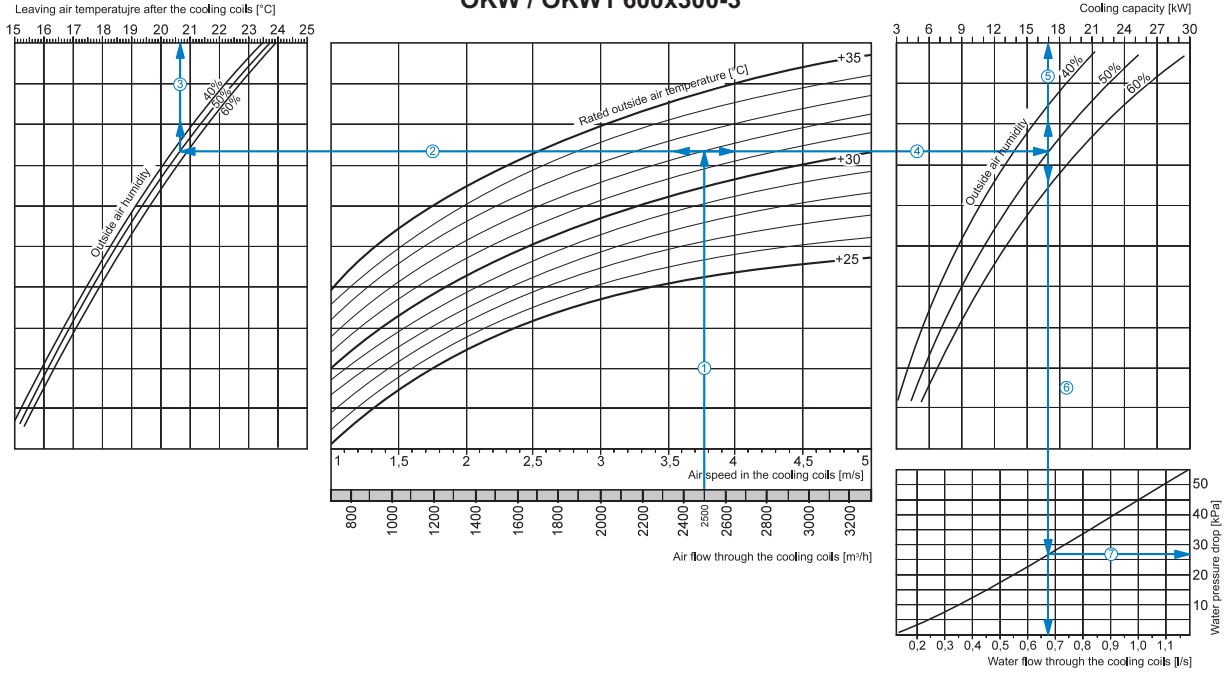

How to use water cooler diagrams

- Air Speed. Starting from 2500 m³/h on the air flow scale draw a vertical line ① till the air speed axis. It makes 3.75 m/s.
- Supply air temperature. Prolong the line ① up to the point where it crosses the outside air temperature (e.g. +32 °C); then draw a horizontal line ② from this point to the left till crossing the outside air humidity (e.g. 50%). From this point draw a vertical line ③ to the supply air temperature at cooler outlet axis on top of the graphic (+20.7 °C).
- Cooling capacity. Prolong the line ① up to the point where it crosses the outside air temperature (e.g. +32 °C) and draw a horizontal line ④ from this point to the right until it crosses the outside air humidity curve (e.g., 50%), from here draw a vertical line ⑤ up to the scale representing the cooling capacity (17.0 kW).
- Water flow. Prolong the line ⑤ down to water flow axis at the bottom of the graphic ⑥ (0.68 l/s).
- Water pressure drop. Draw the line ⑦ from the point where the line ⑥ crosses the black curve to the pressure drop axis. (27.0 kPa).

OKW / OKW1 600x350-3

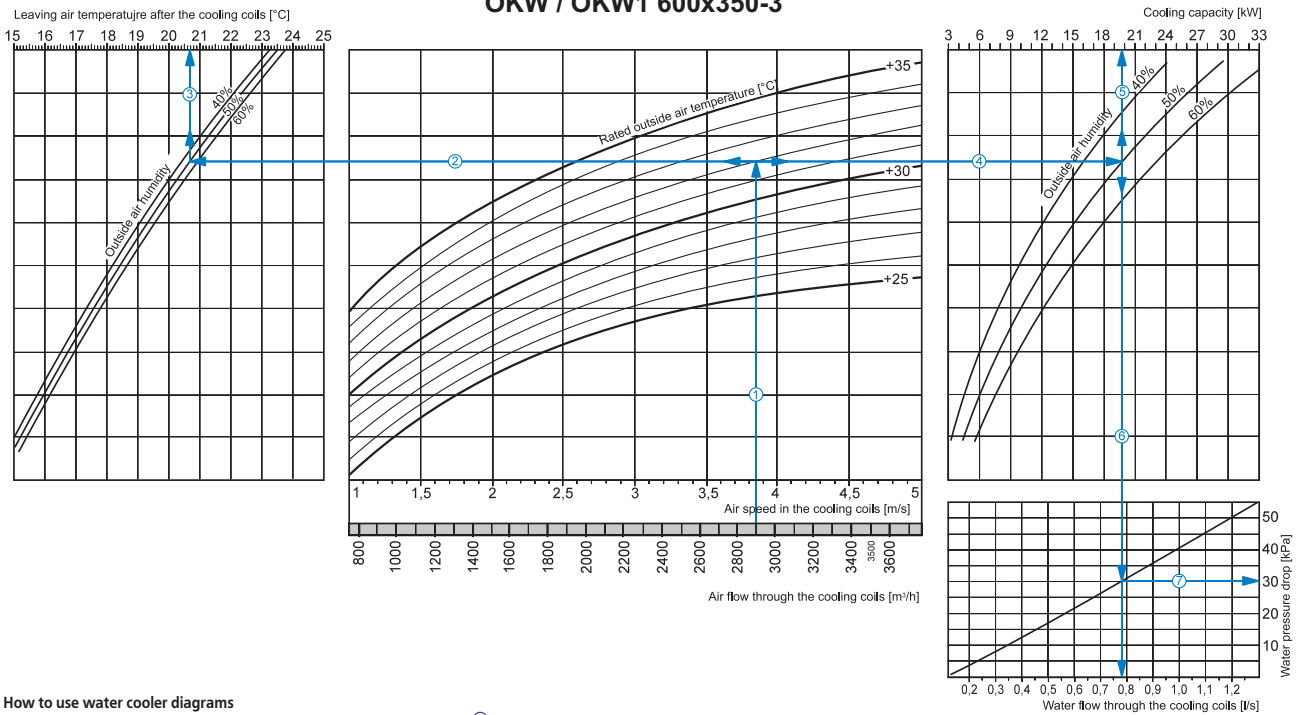

How to use water cooler diagrams

- Air Speed. Starting from 2850 m³/h on the air flow scale draw a vertical line ① till the air speed axis. It makes 3.85 m/s.
- Supply air temperature. Prolong the line ① up to the point where it crosses the outside air temperature (e.g. +32 °C); then draw a horizontal line ② from this point to the left till crossing the outside air humidity (e.g. 50%). From this point draw a vertical line ③ to the supply air temperature at cooler outlet axis on top of the graphic (+20.7 °C).
- Cooling capacity. Prolong the line ① up to the point where it crosses the outside air temperature (e.g. +32 °C) and draw a horizontal line ④ from this point to the right until it crosses the outside air humidity curve (e.g., 50%), from here draw a vertical line ⑤ up to the scale representing the cooling capacity (19.8 kW).
- Water flow. Prolong the line ⑤ down to water flow axis at the bottom of the graphic ⑥ (0.78 l/s).
- Water pressure drop. Draw the line ⑦ from the point where the line ⑥ crosses the black curve to the pressure drop axis. (30.0 kPa).

OKW / OKW1

OKW / OKW1 700x400-3

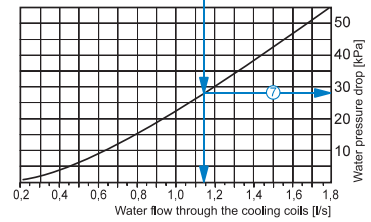
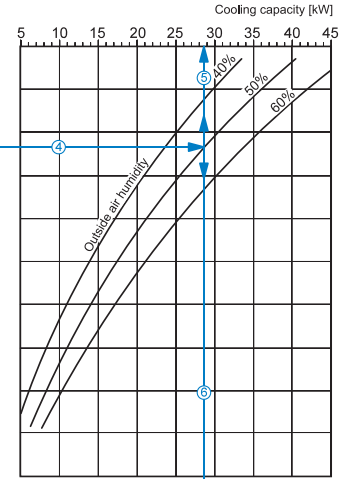
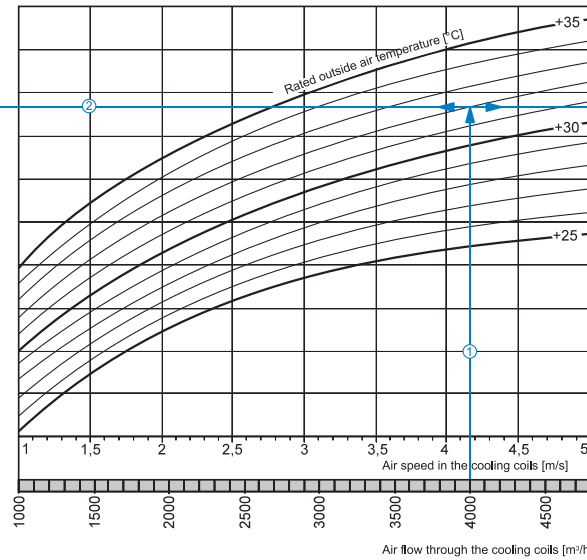
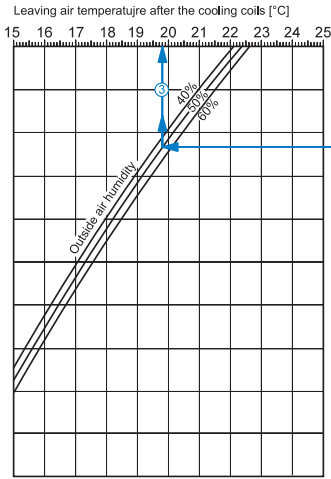

How to use water cooler diagrams

Air Speed. Starting from 4000 m³/h on the air flow scale draw a vertical line ① till the air speed axis. It makes 4.15 m/s.

Supply air temperature. Prolong the line ① up to the point where it crosses the outside air temperature (e.g. +32 °C); then draw a horizontal line ② from this point to the left till crossing the outside air humidity (e.g. 50%). From this point draw a vertical line ③ to the supply air temperature at cooler outlet axis on top of the graphic (+19.8 °C).

Cooling capacity. Prolong the line ① up to the point where it crosses the outside air temperature (e.g. +32 °C) and draw a horizontal line ④ from this point to the right until it crosses the outside air humidity curve (e.g., 50%), from here draw a vertical line ⑤ up to the scale representing the cooling capacity (28.5 kW).

Water flow. Prolong the line ⑤ down to water flow axis at the bottom of the graphic ⑥ (1.14 l/s).

Water pressure drop. Draw the line ⑦ from the point where the line ⑥ crosses the black curve to the pressure drop axis. (28.0 kPa).

OKW / OKW1

OKW / OKW1 800x500-3

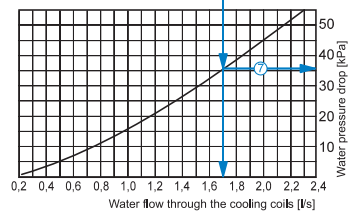
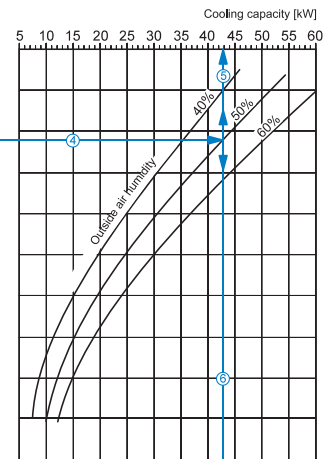
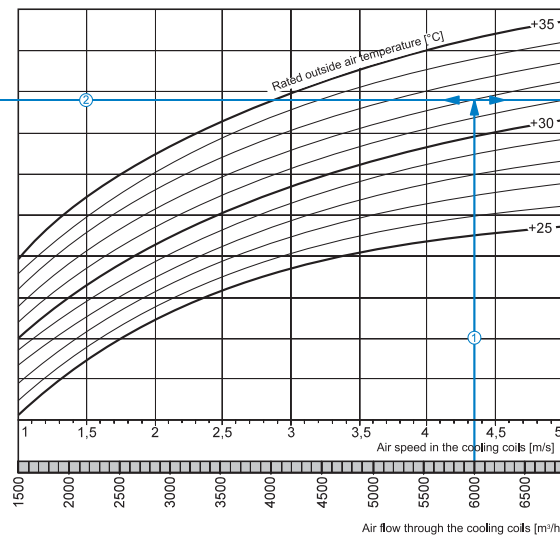
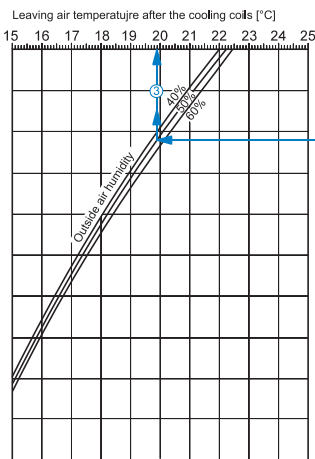

How to use water cooler diagrams

Air Speed. Starting from 6000 m³/h on the air flow scale draw a vertical line ① till the air speed axis. It makes 4.35 m/s.

Supply air temperature. Prolong the line ① up to the point where it crosses the outside air temperature (e.g. +32 °C); then draw a horizontal line ② from this point to the left till crossing the outside air humidity (e.g. 50%). From this point draw a vertical line ③ to the supply air temperature at cooler outlet axis on top of the graphic (+19.9 °C).

Cooling capacity. Prolong the line ① up to the point where it crosses the outside air temperature (e.g. +32 °C) and draw a horizontal line ④ from this point to the right until it crosses the outside air humidity curve (e.g., 50%), from here draw a vertical line ⑤ up to the scale representing the cooling capacity (43 kW).

Water flow. Prolong the line ⑤ down to water flow axis at the bottom of the graphic ⑥ (1.7 l/s).

Water pressure drop. Draw the line ⑦ from the point where the line ⑥ crosses the black curve to the pressure drop axis. (36.0 kPa).

OKW / OKW1 900x500-3

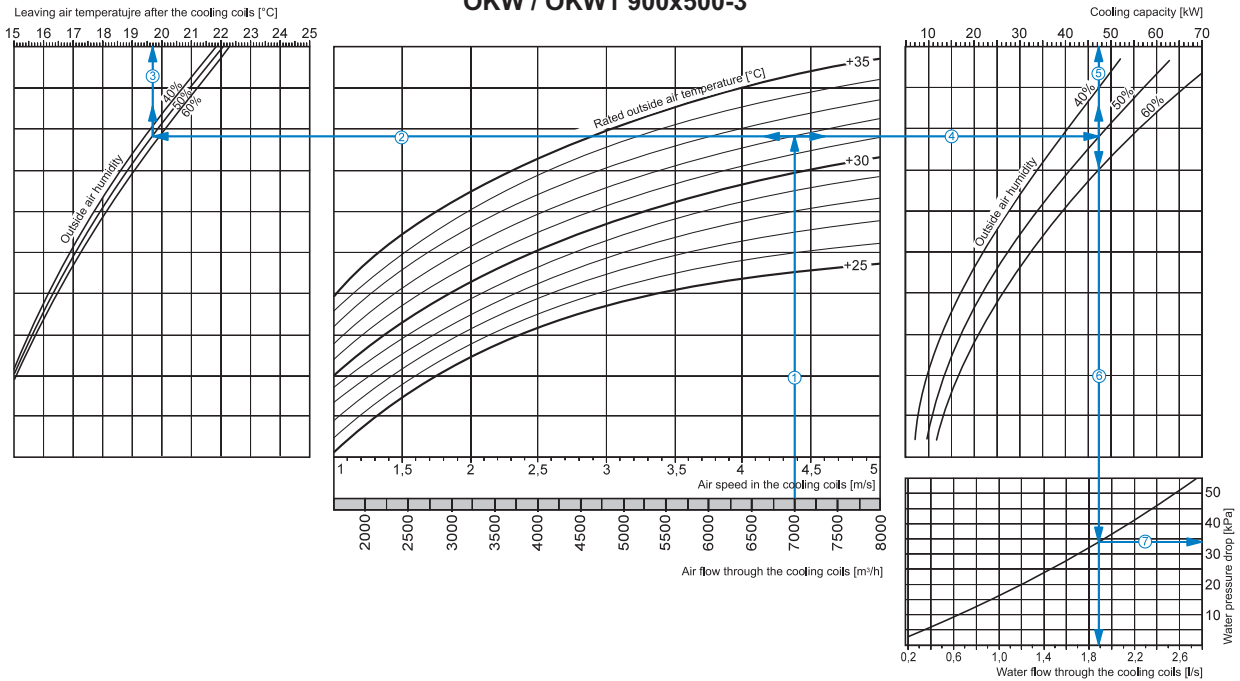

How to use water cooler diagrams

Air Speed. Starting from 7000 m³/h on the air flow scale draw a vertical line ① till the air speed axis. It makes 4.4 m/s.

Supply air temperature. Prolong the line ① up to the point where it crosses the outside air temperature (e.g. +32 °C); then draw a horizontal line ② from this point to the left till crossing the outside air humidity (e.g. 50%). From this point draw a vertical line ③ to the supply air temperature at cooler outlet axis on top of the graphic (+19.7 °C).

Cooling capacity. Prolong the line ① up to the point where it crosses the outside air temperature (e.g. +32 °C) and draw a horizontal line ④ from this point to the right until it crosses the outside air humidity curve (e.g., 50%), from here draw a vertical line ⑤ up to the scale representing the cooling capacity (47.0 kW).

Water flow. Prolong the line ⑤ down to water flow axis at the bottom of the graphic ⑥ (1.9 l/s).

Water pressure drop. Draw the line ⑦ from the point where the line ⑥ crosses the black curve to the pressure drop axis. (34.0 kPa).

OKW / OKW1

OKW / OKW1 1000x500-3

Leaving air temperature after the cooling coils [°C]

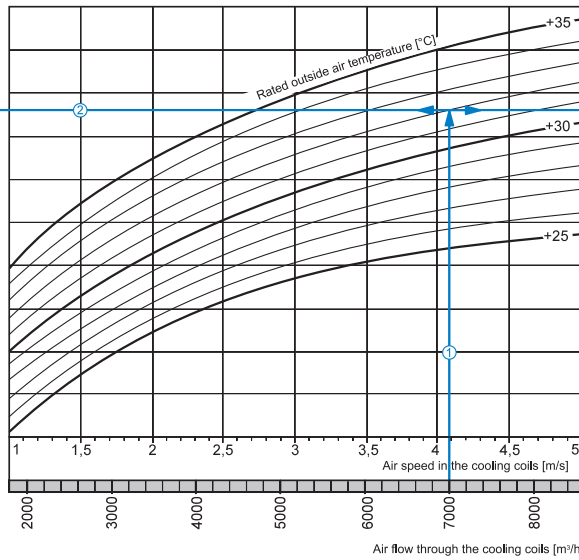
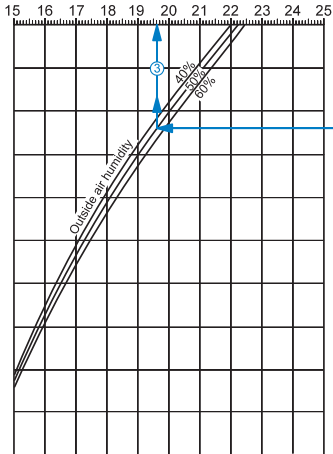

Cooling capacity [kW]

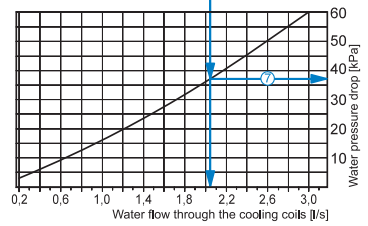
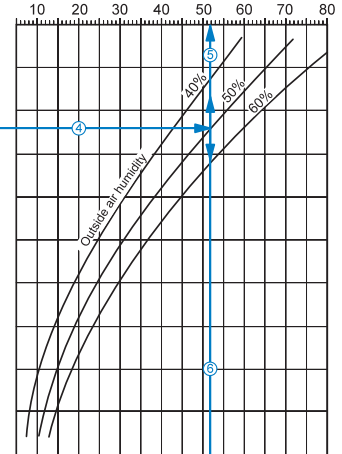

How to use water cooler diagrams

- Air Speed. Starting from 7000 m³/h on the air flow scale draw a vertical line ① till the air speed axis. It makes 4.1 m/s.
- Supply air temperature. Prolong the line ① up to the point where it crosses the outside air temperature (e.g. +32 °C); then draw a horizontal line ② from this point to the left till crossing the outside air humidity (e.g. 50%). From this point draw a vertical line ③ to the supply air temperature at cooler outlet axis on top of the graphic (+19.6 °C).
- Cooling capacity. Prolong the line ① up to the point where it crosses the outside air temperature (e.g. +32 °C) and draw a horizontal line ④ from this point to the right until it crosses the outside air humidity curve (e.g., 50%), from here draw a vertical line ⑤ up to the scale representing the cooling capacity (52.0 kW).
- Water flow. Prolong the line ⑤ down to water flow axis at the bottom of the graphic ⑥ (2.05 l/s).
- Water pressure drop. Draw the line ⑦ from the point where the line ⑥ crosses the black curve to the pressure drop axis. (37.0 kPa).

Series
OKF



Series
OKF1



■ **Applications**

Direct-expansion duct coolers are designed for cooling of supply air in rectangular ventilation systems and can be used either for supply or supply and exhaust units.

■ **Design**

The DX coolers are available in OKF and OKF1 modifications. The OKF1 cooler has a simplified design. The cooler casing is made of galvanized steel, the piping is made of copper tubes and the heat exchange surface is made of aluminium plates. The coolers are available in 3 rows modification and designed for operation with R123, R134a, R152a, R404a, R407C, R410a, R507, R12, R22 cooling agents. It is equipped with a droplet separator and a drain pan for condensate collection and removal.

For OKF and OKF1 models by default the service side is located on the right side from the air stream direction. The OKF cooler service side location can be changed by coil turning by 180°. The OKF1 modification does not have this option.

■ **Mounting**

- ▶ Mounting is effected by means of flange connection. Direct-expansion cooling coils, can be installed horizontally only to enable the condensate draining.
- ▶ Installation shall be performed in such a way as to provide the uniform air stream distribution along the

entire cross section.

- ▶ The air filter shall be installed at the cooler inlet to ensure the cooler protection against dirt and dusting.
- ▶ The cooler can be installed at the fan inlet or outlet. If the cooler is located at the fan outlet the air duct between the cooler and the fan shall be at least 1-1.5 m long to ensure the air stream stabilization.
- ▶ To attain the maximum cooling capacity the cooler must be connected on counter-flow basis. All the nomographic charts in the catalogue are valid for such connection.
- ▶ The droplet separator is made of polypropylene profile and prevents condensate dripping from the

cooling tubes by the cooling air flow. While selecting a cooler type consider that the most suitable speed of the air flow for the efficient droplet separator operation is up to 4 m/s.

- ▶ Condensate draining from the cooler shall be performed through the U-trap. The U-trap height depends on the total pressure in the fan. The trap height can be calculated using the figure and the table below.

H [mm]	K [mm]	P [Pa]
100	55	600
200	105	1100
260	140	1400

H – trap height
K – drain height
P – total pressure in the fan

- ▶ To ensure the correct and safe cooler operation use the automation system providing the complex control and automatic regulation of the cooling capacity and air cooling temperature.

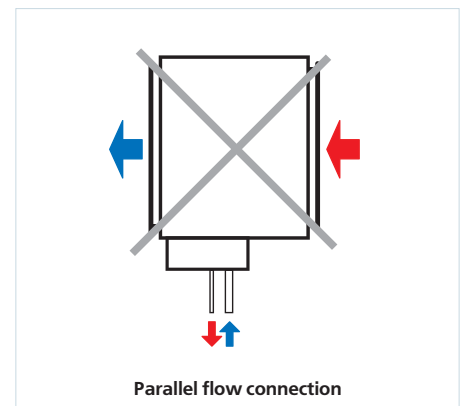
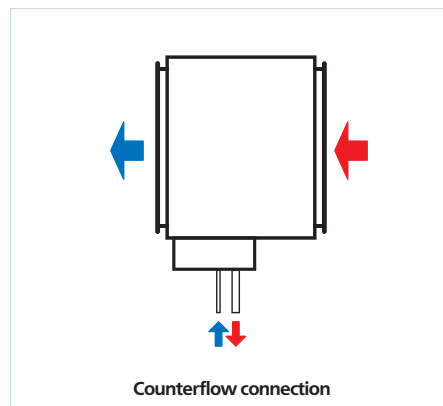

Designation key:

Series	Flange dimensions (WxH) [mm]	Number of cooling coils
OKF / OKF1	400x200; 500x250; 500x300; 600x300; 600x350; 700x400; 800x500; 900x500; 1000x500	3

Overall dimensions:

Type	Dimensions [mm]											
	B	B1	B2	B3	H	H1	H2	H3	H4	L	D1	D2
OKF 400x200-3	400	420	440	470	200	220	240	295	103	44	12	22
OKF 500x250-3	500	520	540	570	250	270	290	345	155	44	12	22
OKF 500x300-3	500	520	540	570	300	320	340	395	210	33	12	22
OKF 600x300-3	600	620	640	670	300	320	340	395	199	44	18	28
OKF 600x350-3	600	620	640	670	350	370	390	445	199	44	18	28
OKF 700x400-3	700	720	740	770	400	420	440	495	224	44	22	28
OKF 800x500-3	800	820	840	870	500	520	540	595	340	44	22	28
OKF 900x500-3	900	920	940	970	500	520	540	595	340	44	22	28
OKF 1000x500-3	1000	1020	1040	1070	500	520	540	595	325	44	22	28

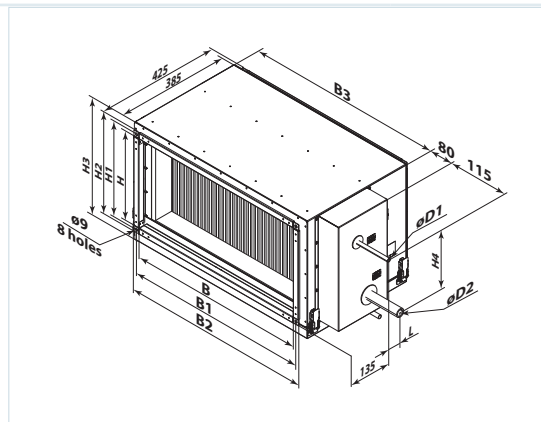

Overall dimensions:

Type	Dimensions [mm]									
	B	B1	B2	H	H1	H2	H3	L	D1	D2
OKF1 400x200-3	400	420	580	200	220	270	103	44	12	22
OKF1 500x250-3	500	520	680	250	270	320	155	44	12	22
OKF1 500x300-3	500	520	680	300	320	370	210	33	12	22
OKF1 600x300-3	600	620	780	300	320	370	199	44	18	28
OKF1 600x350-3	600	620	780	350	370	420	199	44	18	28
OKF1 700x400-3	700	720	880	400	420	470	224	44	22	28
OKF1 800x500-3	800	820	980	500	520	570	340	44	22	28
OKF1 900x500-3	900	920	1080	500	520	570	340	44	22	28
OKF1 1000x500-3	1000	1020	1180	500	520	570	325	44	22	28

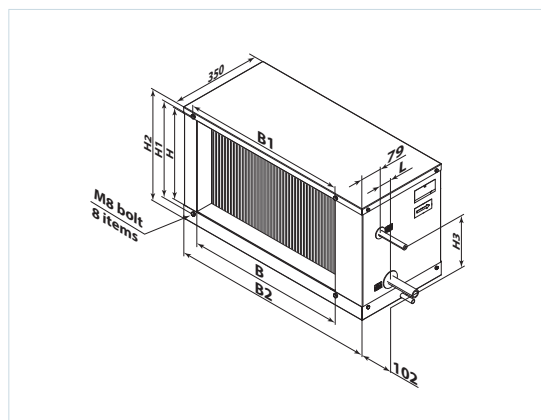

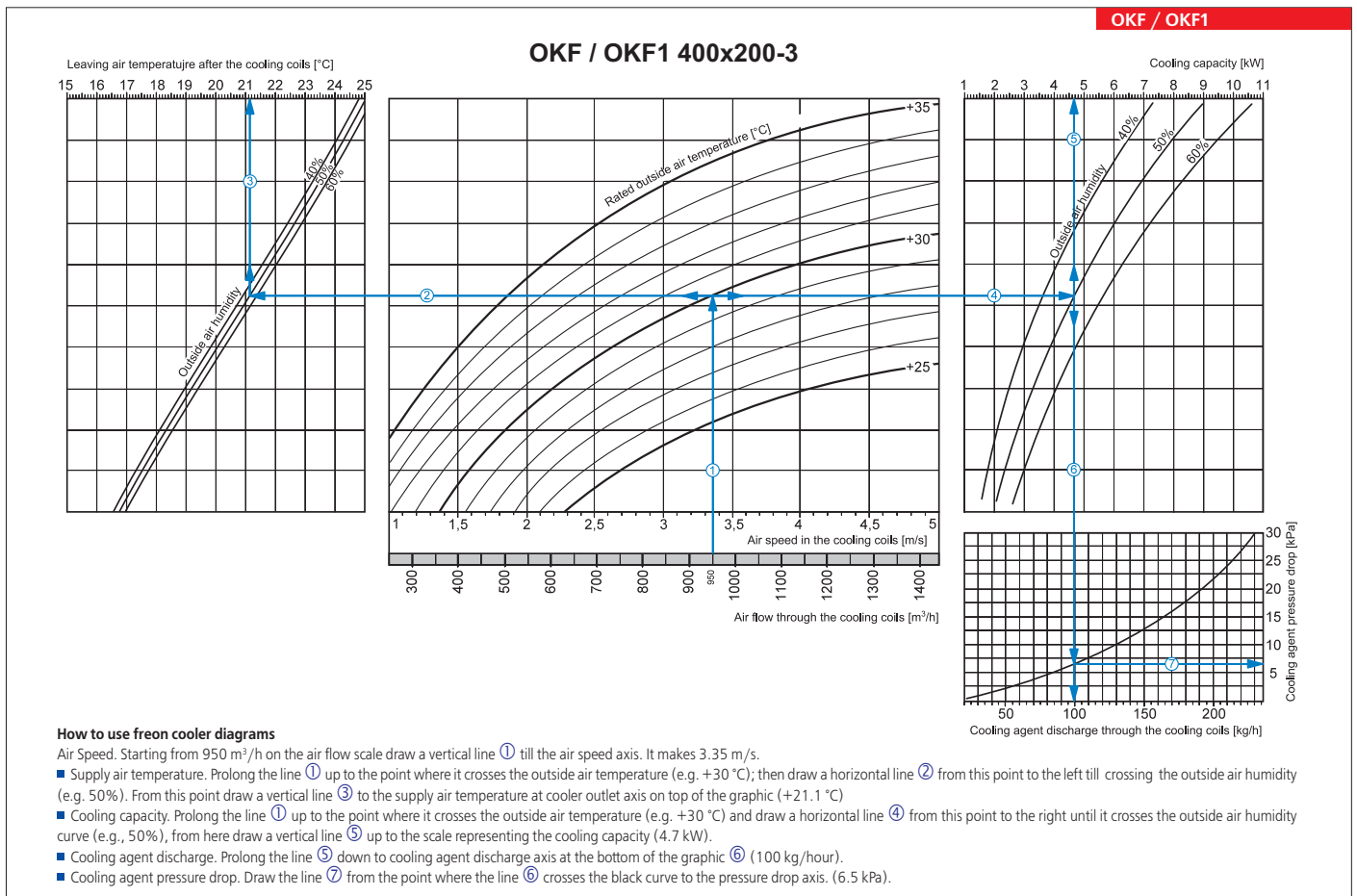
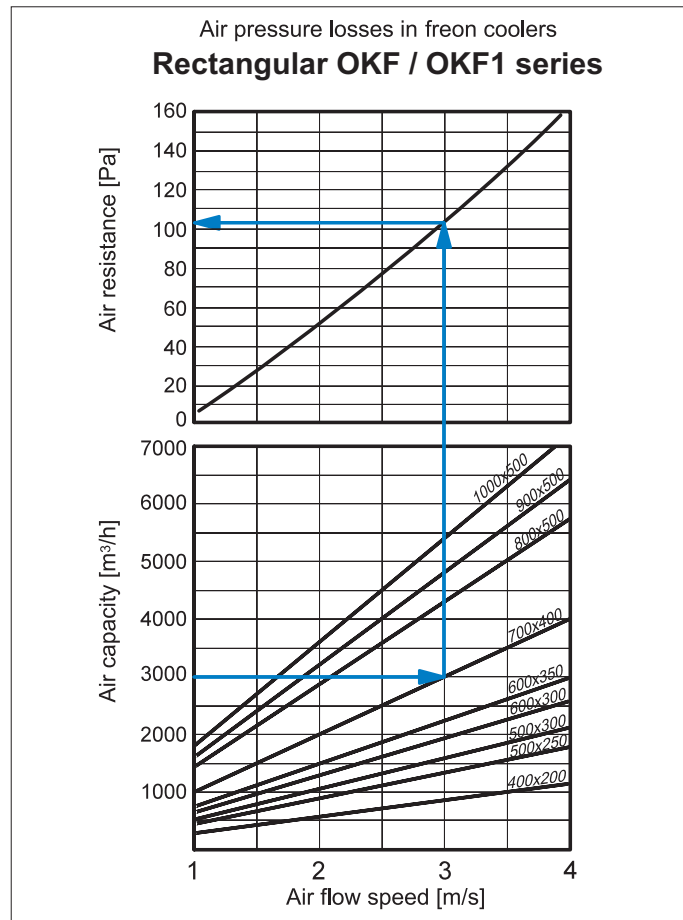

OKF / OKF1

OKF / OKF1 500x250-3

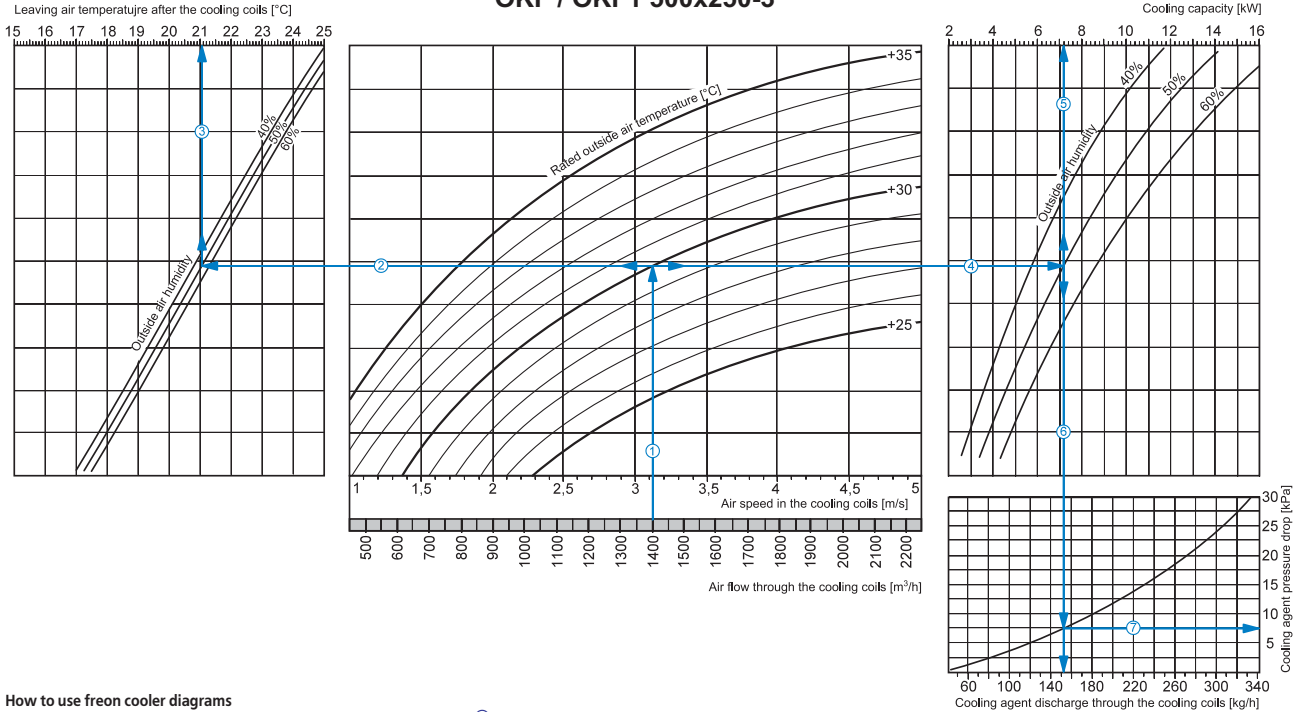

How to use freon cooler diagrams

Air Speed. Starting from 1400 m³/h on the air flow scale draw a vertical line ① till the air speed axis. It makes 3.1 m/s.

Supply air temperature. Prolong the line ① up to the point where it crosses the outside air temperature (e.g. +30 °C); then draw a horizontal line ② from this point to the left till crossing the outside air humidity (e.g. 50%). From this point draw a vertical line ③ to the supply air temperature at cooler outlet axis on top of the graphic (+21.1 °C).

Cooling capacity. Prolong the line ① up to the point where it crosses the outside air temperature (e.g. +30 °C) and draw a horizontal line ④ from this point to the right until it crosses the outside air humidity curve (e.g., 50%), from here draw a vertical line ⑤ up to the scale representing the cooling capacity (7.2 kW).

Cooling agent discharge. Prolong the line ⑤ down to cooling agent discharge axis at the bottom of the graphic ⑥ (152 kg/hour).

Cooling agent pressure drop. Draw the line ⑦ from the point where the line ⑥ crosses the black curve to the pressure drop axis. (7.5 kPa).

OKF / OKF1

OKF / OKF1 500x300-3

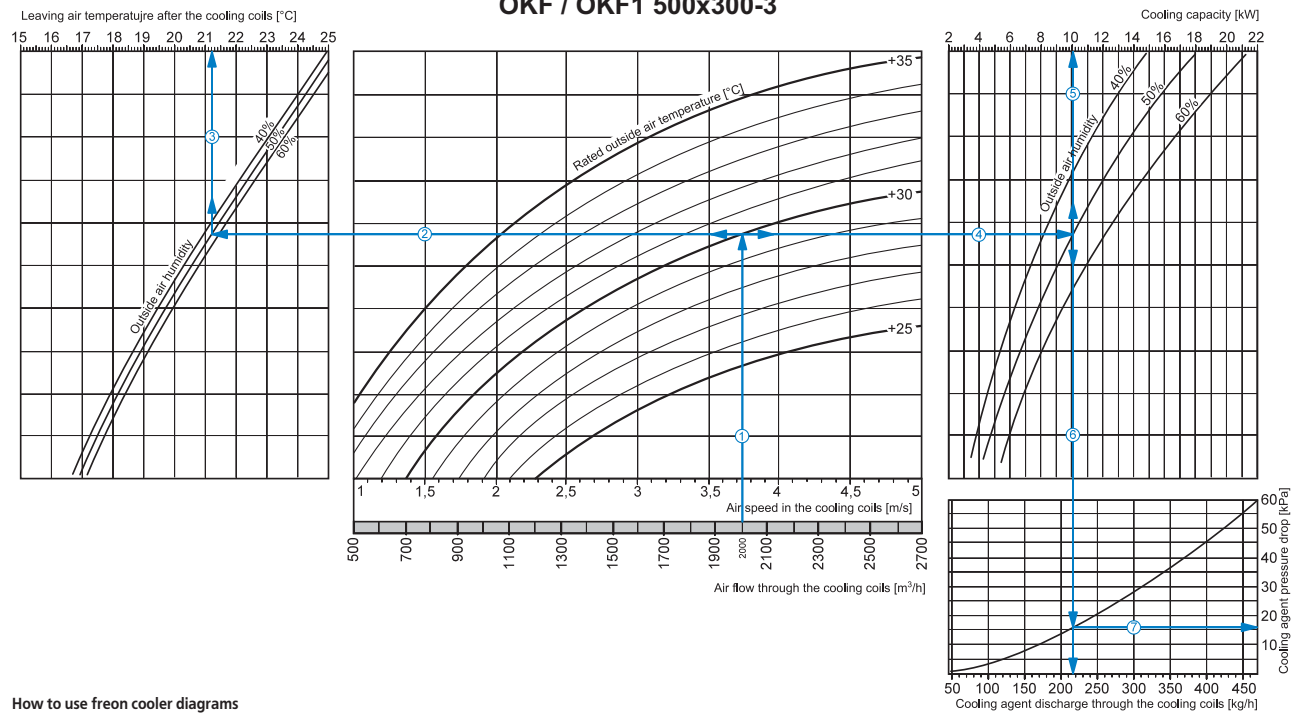

How to use freon cooler diagrams

Air Speed. Starting from 2000 m³/h on the air flow scale draw a vertical line ① till the air speed axis. It makes 3.75 m/s.

Supply air temperature. Prolong the line ① up to the point where it crosses the outside air temperature (e.g. +30 °C); then draw a horizontal line ② from this point to the left till crossing the outside air humidity (e.g. 50%). From this point draw a vertical line ③ to the supply air temperature at cooler outlet axis on top of the graphic (+21.2 °C).

Cooling capacity. Prolong the line ① up to the point where it crosses the outside air temperature (e.g. +30 °C) and draw a horizontal line ④ from this point to the right until it crosses the outside air humidity curve (e.g., 50%), from here draw a vertical line ⑤ up to the scale representing the cooling capacity (10 kW).

Cooling agent discharge. Prolong the line ⑤ down to cooling agent discharge axis at the bottom of the graphic ⑥ (215 kg/hour).

Cooling agent pressure drop. Draw the line ⑦ from the point where the line ⑥ crosses the black curve to the pressure drop axis. (16.0 kPa).

OKF / OKF1 600x300-3

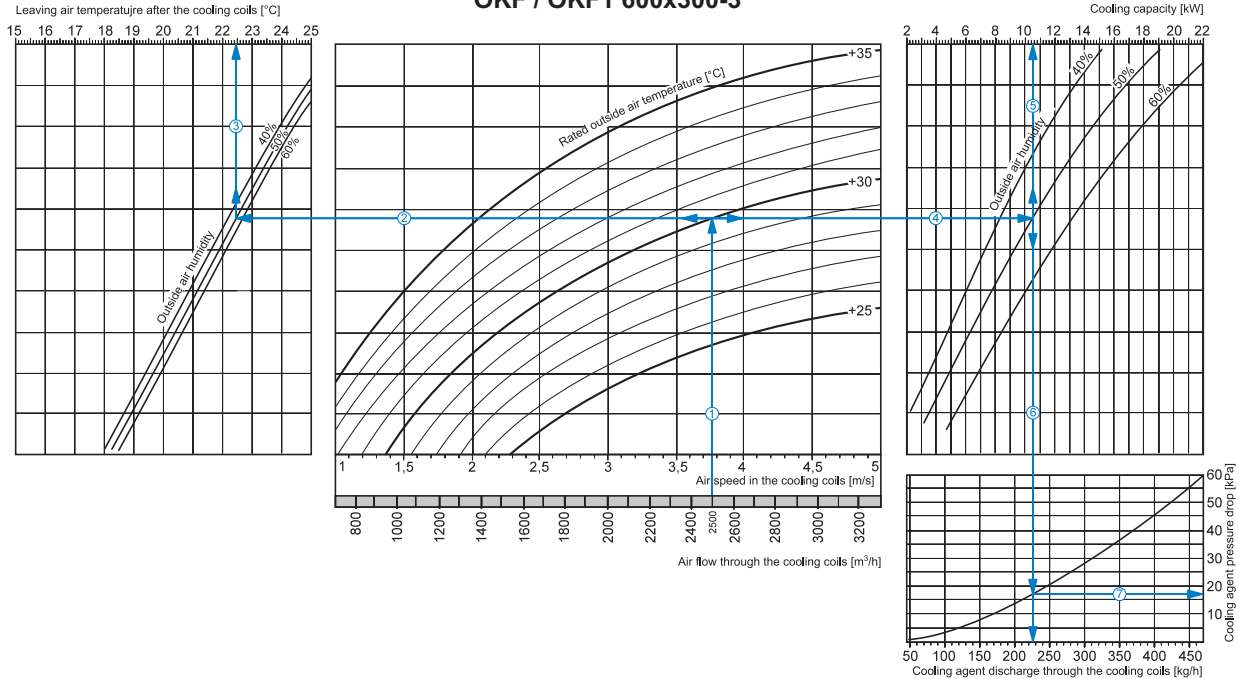

How to use freon cooler diagrams

Air Speed. Starting from 2500 m³/h on the air flow scale draw a vertical line ① till the air speed axis. It makes 3.75 m/s.

- Supply air temperature. Prolong the line ① up to the point where it crosses the outside air temperature (e.g. +30 °C); then draw a horizontal line ② from this point to the left till crossing the outside air humidity (e.g. 50%). From this point draw a vertical line ③ to the supply air temperature at cooler outlet axis on top of the graphic (+22.5 °C).
- Cooling coil capacity. Prolong the line ① up to the point where it crosses the outside air temperature (e.g. +30 °C) and draw a horizontal line ④ from this point to the right until it crosses the outside air humidity curve (e.g., 50%), from here draw a vertical line ⑤ up to the scale representing the cooling capacity (10.5 kW).
- Cooling agent discharge. Prolong the line ⑤ down to cooling agent discharge axis at the bottom of the graphic ⑥ (225 kg/hour).
- Cooling agent pressure drop. Draw the line ⑦ from the point where the line ⑥ crosses the black curve to the pressure drop axis. (17.0 kPa).

OKF / OKF1 600x350-3

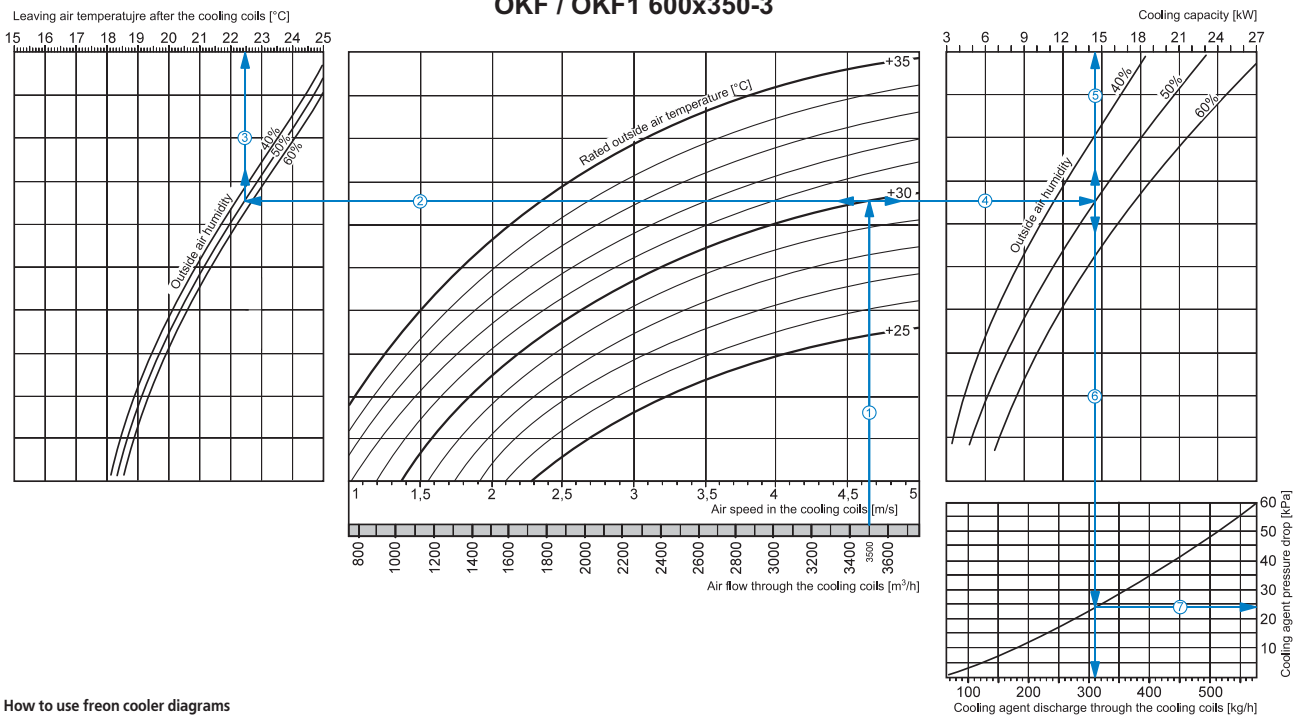

How to use freon cooler diagrams

Air Speed. Starting from 3500 m³/h on the air flow scale draw a vertical line ① till the air speed axis. It makes 4.65 m/s.

- Supply air temperature. Prolong the line ① up to the point where it crosses the outside air temperature (e.g. +30 °C); then draw a horizontal line ② from this point to the left till crossing the outside air humidity (e.g. 50%). From this point draw a vertical line ③ to the supply air temperature at cooler outlet axis on top of the graphic (+22.5 °C).
- Cooling coil capacity. Prolong the line ① up to the point where it crosses the outside air temperature (e.g. +30 °C) and draw a horizontal line ④ from this point to the right until it crosses the outside air humidity curve (e.g., 50%), from here draw a vertical line ⑤ up to the scale representing the cooling capacity (14.5 kW).
- Cooling agent discharge. Prolong the line ⑤ down to cooling agent discharge axis at the bottom of the graphic ⑥ (310 kg/hour).
- Cooling agent pressure drop. Draw the line ⑦ from the point where the line ⑥ crosses the black curve to the pressure drop axis. (24.0 kPa).

OKF / OKF1

OKF / OKF1 700x400-3

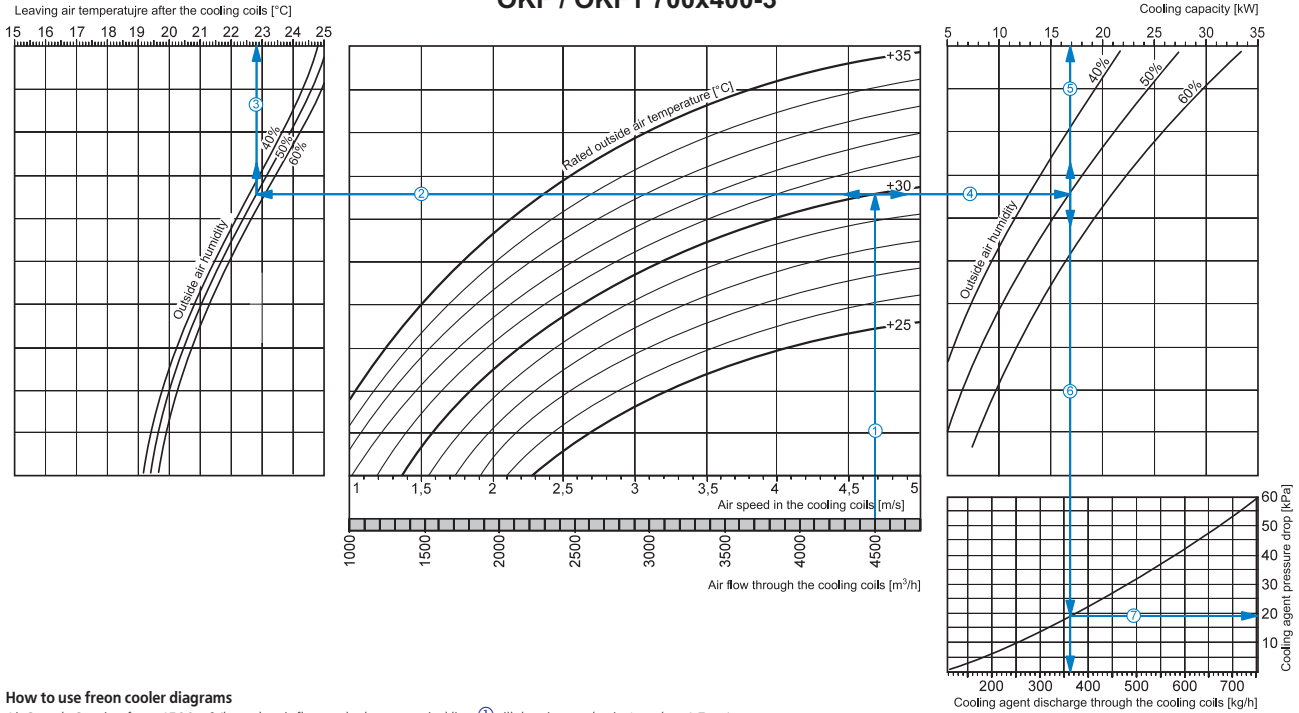

How to use freon cooler diagrams

Air Speed. Starting from 4500 m³/h on the air flow scale draw a vertical line ① till the air speed axis. It makes 4.7 m/s.

Supply air temperature. Prolong the line ① up to the point where it crosses the outside air temperature (e.g. +30 °C); then draw a horizontal line ② from this point to the left till crossing the outside air humidity (e.g. 50%). From this point draw a vertical line ③ to the supply air temperature at cooler outlet axis on top of the graphic (+22.8 °C).

Cooling coil capacity. Prolong the line ① up to the point where it crosses the outside air temperature (e.g. +30 °C) and draw a horizontal line ④ from this point to the right until it crosses the outside air humidity curve (e.g., 50%), from here draw a vertical line ⑤ up to the scale representing the cooling capacity (17.0 kW).

Cooling agent discharge. Prolong the line ⑤ down to cooling agent discharge axis at the bottom of the graphic ⑥ (360 kg/hour).

Cooling agent pressure drop. Draw the line ⑦ from the point where the line ⑥ crosses the black curve to the pressure drop axis. (19.0 kPa).

OKF / OKF1

OKF / OKF1 800x500-3

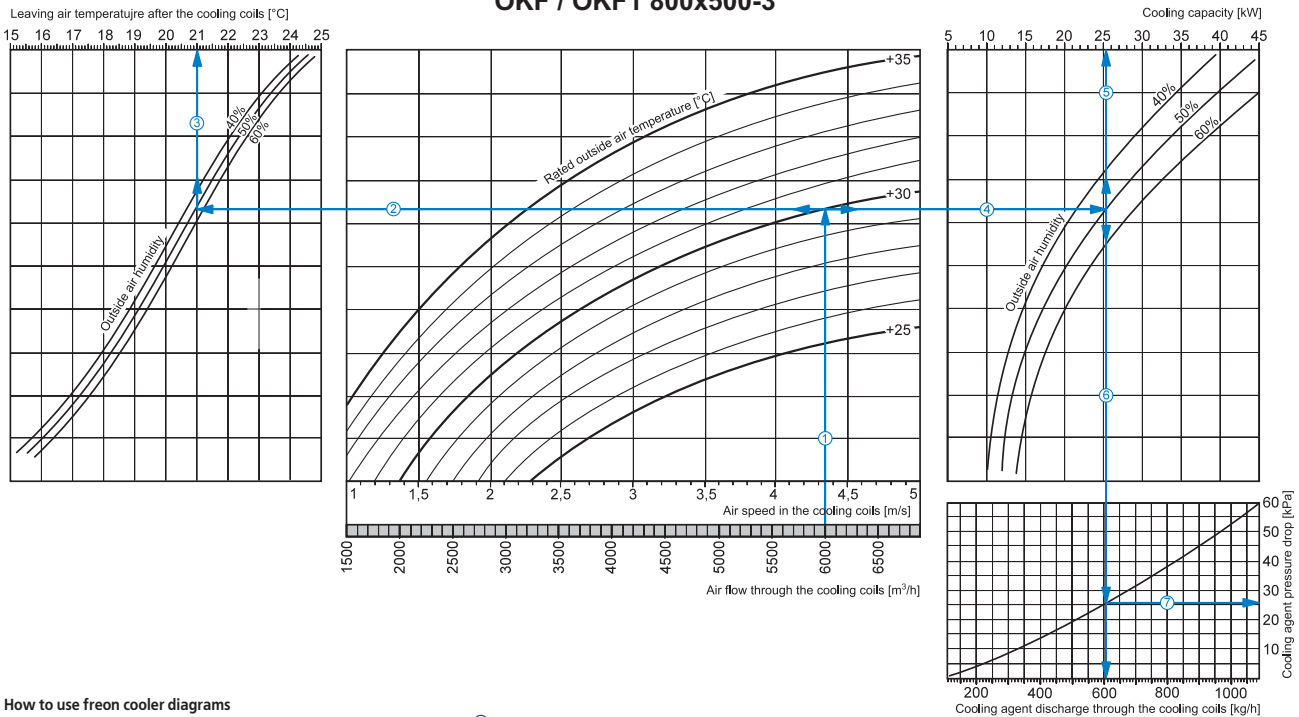

How to use freon cooler diagrams

Air Speed. Starting from 6000 m³/h on the air flow scale draw a vertical line ① till the air speed axis. It makes 4.35 m/s.

Supply air temperature. Prolong the line ① up to the point where it crosses the outside air temperature (e.g. +30 °C); then draw a horizontal line ② from this point to the left till crossing the outside air humidity (e.g. 50%). From this point draw a vertical line ③ to the supply air temperature at cooler outlet axis on top of the graphic (+21.0 °C).

Cooling coil capacity. Prolong the line ① up to the point where it crosses the outside air temperature (e.g. +30 °C) and draw a horizontal line ④ from this point to the right until it crosses the outside air humidity curve (e.g., 50%), from here draw a vertical line ⑤ up to the scale representing the cooling capacity (25.5 kW).

Cooling agent discharge. Prolong the line ⑤ down to cooling agent discharge axis at the bottom of the graphic ⑥ (605 kg/hour).

Cooling agent pressure drop. Draw the line ⑦ from the point where the line ⑥ crosses the black curve to the pressure drop axis. (26.0 kPa).

OKF / OKF1 900x500-3

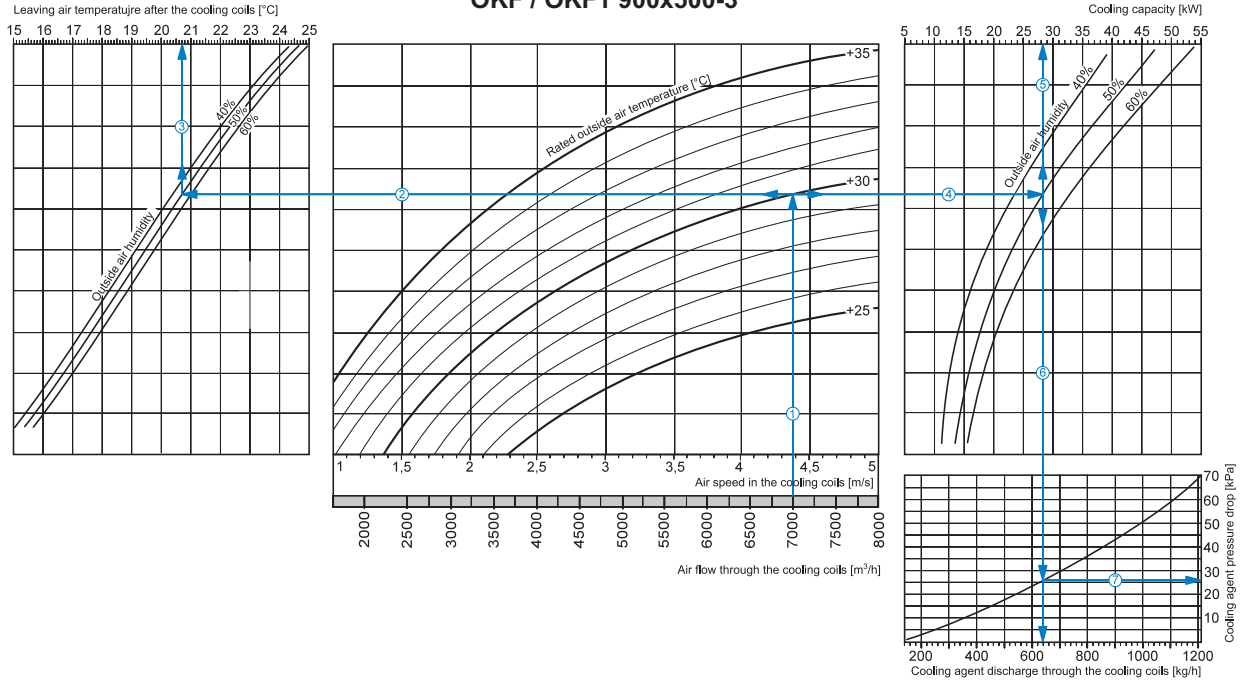

How to use freon cooler diagrams

Air Speed. Starting from 7000 m³/h on the air flow scale draw a vertical line ① till the air speed axis. It makes 4.4 m/s.

- Supply air temperature. Prolong the line ① up to the point where it crosses the outside air temperature (e.g. +30 °C); then draw a horizontal line ② from this point to the left till crossing the outside air humidity (e.g. 50%). From this point draw a vertical line ③ to the supply air temperature at cooler outlet axis on top of the graphic (+20.7 °C).
- Cooling coil capacity. Prolong the line ① up to the point where it crosses the outside air temperature (e.g. +30 °C) and draw a horizontal line ④ from this point to the right until it crosses the outside air humidity curve (e.g., 50%), from here draw a vertical line ⑤ up to the scale representing the cooling capacity (28.0 kW).
- Cooling agent discharge. Prolong the line ⑤ down to cooling agent discharge axis at the bottom of the graphic ⑥ (640 kg/hour).
- Cooling agent pressure drop. Draw the line ⑦ from the point where the line ⑥ crosses the black curve to the pressure drop axis. (26.0 kPa).

OKF / OKF1

OKF / OKF1 1000x500-3

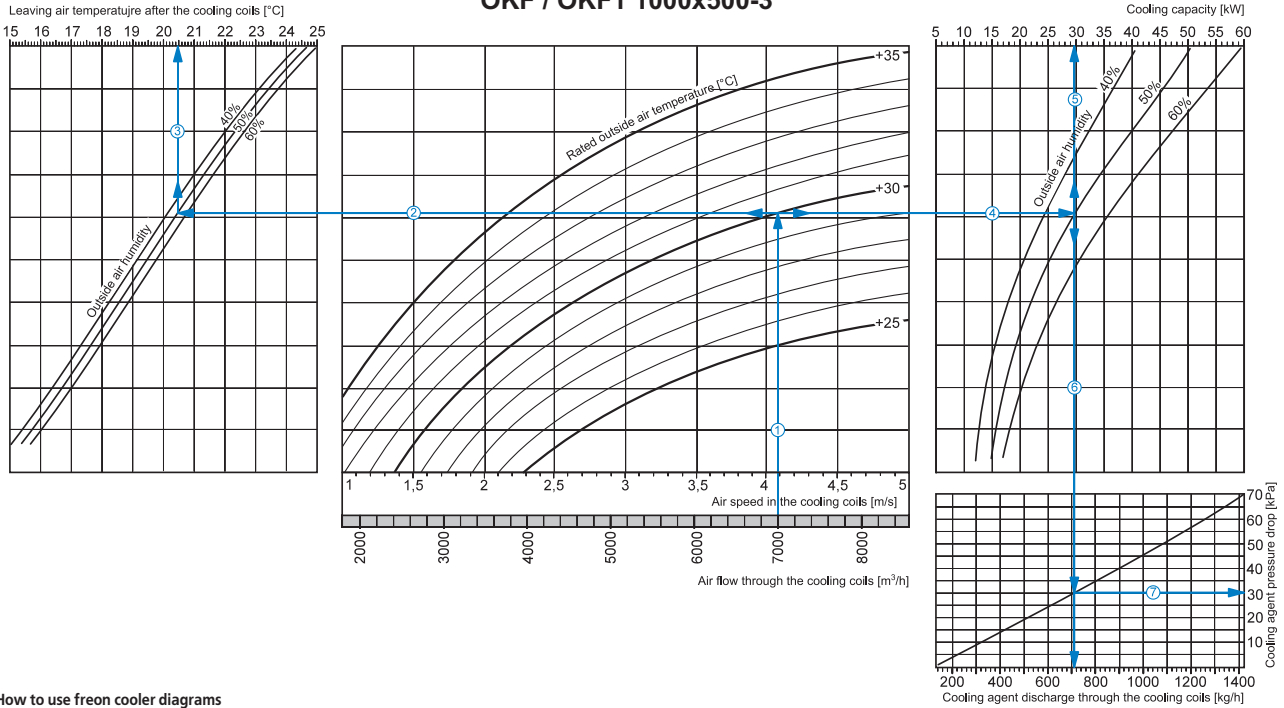

How to use freon cooler diagrams

Air Speed. Starting from 7000 m³/h on the air flow scale draw a vertical line ① till the air speed axis. It makes 4.1 m/s.

Supply air temperature. Prolong the line ① up to the point where it crosses the outside air temperature (e.g. +30 °C); then draw a horizontal line ② from this point to the left till crossing the outside air humidity (e.g. 50%). From this point draw a vertical line ③ to the supply air temperature at cooler outlet axis on top of the graphic (+20.5 °C).

Cooling coil capacity. Prolong the line ① up to the point where it crosses the outside air temperature (e.g. +30 °C) and draw a horizontal line ④ from this point to the right until it crosses the outside air humidity curve (e.g., 50%), from here draw a vertical line ⑤ up to the scale representing the cooling capacity (30.0 kW).

Cooling agent discharge. Prolong the line ⑤ down to cooling agent discharge axis at the bottom of the graphic ⑥ (710 kg/hour).

Cooling agent pressure drop. Draw the line ⑦ from the point where the line ⑥ crosses the black curve to the pressure drop axis. (30.0 kPa).

Series
SR



■ **Applications**

The plate silencer is applied for noise absorption produced during the ventilating equipment operation and spread along the ducting systems. Suitable for installation into rectangular ducts. The silencer reduces the noise level in the air duct significantly (refer the diagram «Noise level reduction»). The silencer is applied jointly with the sound-insulated fan

in case of high noise level requirements not only to the air duct but to the equipment in general.

■ **Design**

Silencer casing and plate shells are made of galvanized steel. The plates are filled with flameproof sound insulating material with protecting covering to prevent the fiber blowing-out.

■ **Mounting**

The mounting is performed by means of flange connection with respect to air flow direction (indicated with an arrow on the casing). The straight portion of at least 1 m long before the silencer is recommended to provide the peak efficiency. Installation in series is preferable to attain the better effect.

	Noise level reduction, dB (Octave-frequency band [Hz])							
	63 Hz	125 Hz	250 Hz	500 Hz	1000 Hz	2000 Hz	4000 Hz	8000 Hz
SR 400x200	3	7	10	23	27	30	25	22
SR 500x250	3	6	11	22	26	25	27	22
SR 500x300	3	6	10	23	24	25	23	18
SR 600x300	3	6	10	21	24	30	24	17
SR 600x350	3	5	11	22	25	29	24	21
SR 700x400	4	7	10	15	22	19	21	18
SR 800x500	5	6	11	17	21	20	22	20
SR 900x500	3	6	10	16	20	20	21	15
SR 1000x500	4	6	11	16	21	21	23	17

Designation key:

Series	Flange dimensions (WxH) [mm]
SR	400x200; 500x250; 500x300; 600x300; 600x350; 700x400; 800x500; 900x500; 1000x500

Overall dimensions:

Type	Dimensions [mm]							Weight [kg]
	B	B1	B2	H	H1	H2	L	
SR 400x200	400	420	440	200	220	240	950	18.5
SR 500x250	500	520	540	250	270	290	950	20.5
SR 500x300	500	520	540	300	320	340	950	24.5
SR 600x300	600	620	640	300	320	340	950	26.5
SR 600x350	600	620	640	350	370	390	950	28.7
SR 700x400	700	720	740	400	420	440	1010	36.7
SR 800x500	800	820	840	500	520	540	1010	50.0
SR 900x500	900	920	940	500	520	540	1010	51.7
SR 1000x500	1000	1020	1040	500	520	540	1010	57.3

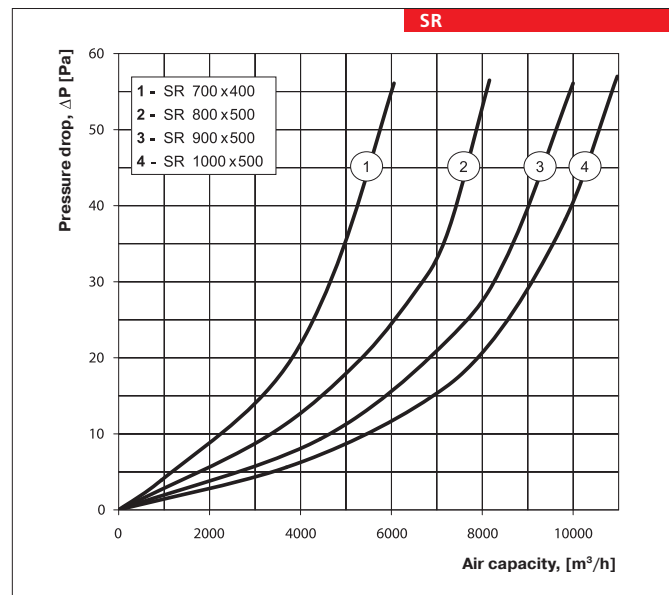
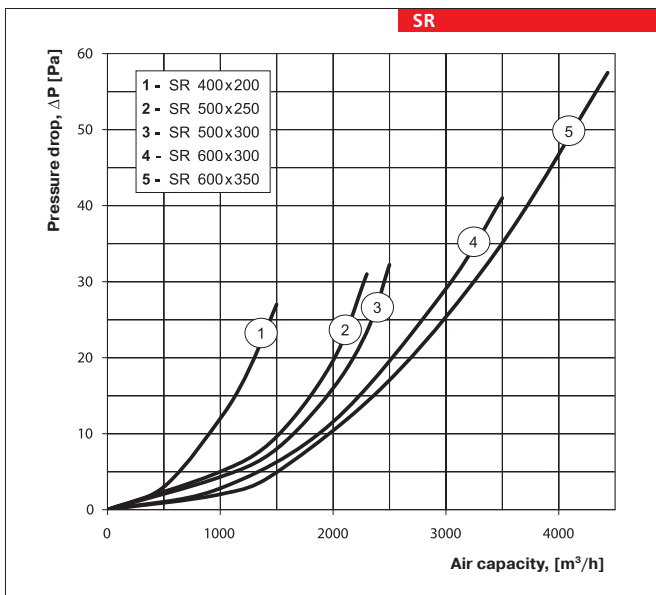
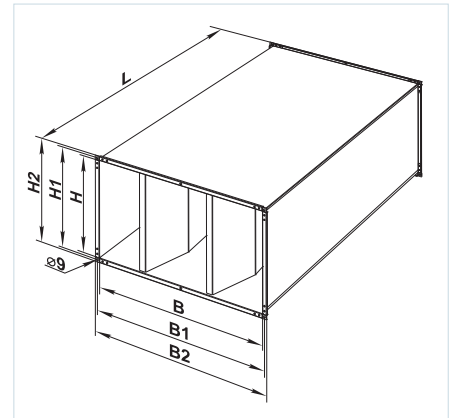
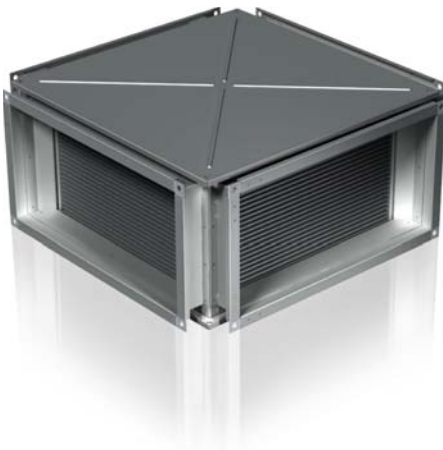

PLATE HEAT EXCHANGERS FOR RECTANGULAR DUCTS

Series PR



■ Applications

PR plate heat exchanger with X-shaped air passage designed for exhaust air heat recovery in conditioning and ventilating systems. The heat exchangers are connected directly to the rectangular ducts both with parallel and perpendicular or diagonal ducting at 45°. Various connection modifications are possible due to bend fittings which shall be ordered in the required quantity. The transported air shall not contain solid, fibrous, aggressive and explosive impurities.

■ Design

The heat exchanger casing is made of galvanized steel. The surface of the heat exchanger consists of thin aluminium plates for efficient heat exchange. Some condensate quantity which can be generated at exhaust

surface can be removed at the bottom removable panel. PR heat exchangers equipment list includes connecting pipe on the bottom panel for condensate removing.

■ Technical data

Heat recovery efficiency and air resistance in the air duct are the basic factors that determine the heat exchanger performance. The thermal efficiency is calculated as following:

$$\eta = \frac{t_s - t_i}{t_e - t_i}$$

t_s – supply air temperature after heat recuperation;

t_i – intake air temperature before heat recuperation;

t_e – extract air temperature before heat recuperation.

Accessory

PK bend

Designed for easy mounting of the heat exchanger in any modifications of the air duct.

Bend designation
PK 600 x 300



Accessory

Summer block VL

For the summer period the heat exchanger can be replaced with the summer block VL which performs no heat recovery but reduces pressure loss by 10%. It is applied in systems without by-pass at the inlet and in systems with no cooling.

Possible layout arrangements of PR heat exchanger and bends PK:

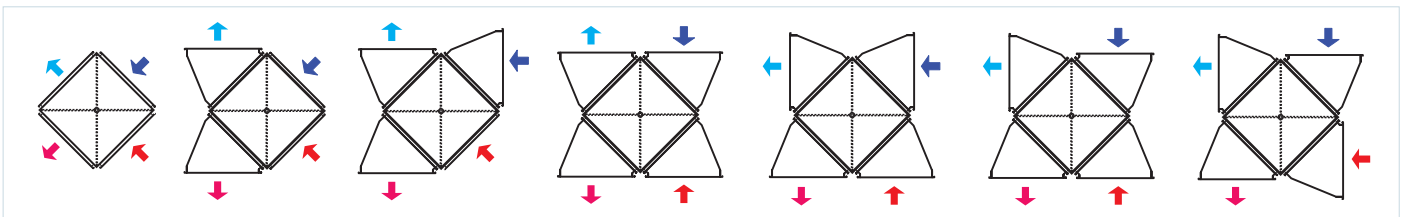

Designation key:

Series	Flange dimensions (WxH) [mm]
PR PK	400x200; 500x250; 500x300; 600x300; 600x350; 700x400; 800x500; 900x500; 1000x500
VL	400x200; 500x250; 500x300; 600x300; 600x350; 700x400; 800x500; 900x500; 1000x500

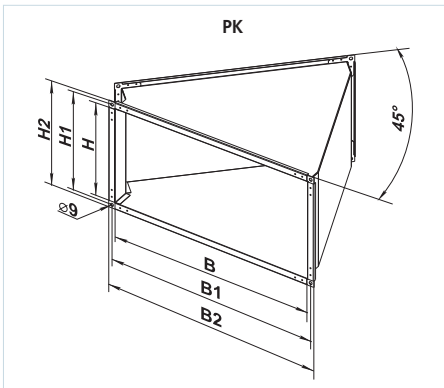

Overall dimensions:

Type	Dimensions [mm]						Weight [kg]
	B	B1	B2	H	H1	H2	
PK 400x200	400	420	440	200	220	240	2.2
PK 500x250	500	520	540	250	270	290	3.3
PK 500x300	500	520	540	300	320	340	3.5
PK 600x300	600	620	640	300	320	340	4.5
PK 600x350	600	620	640	350	370	390	4.7
PK 700x400	700	720	740	400	420	440	5.9
PK 800x500	800	820	840	500	520	540	7.5
PK 900x500	900	920	940	500	520	540	8.7
PK 1000x500	1000	1020	1040	500	520	540	10.3

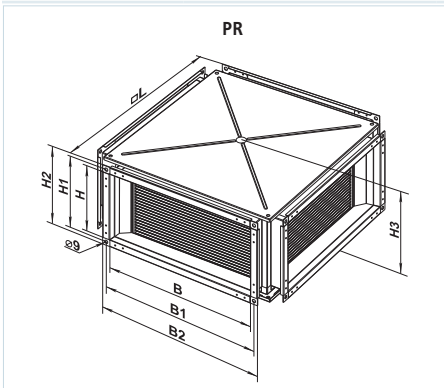

Overall dimensions:

Type	Dimensions [mm]								Weight [kg]
	B	B1	B2	H	H1	H2	H3	L	
PR 400x200	400	420	440	200	220	240	275	530	17.1
PR 500x250	500	520	540	250	270	290	325	630	22.6
PR 500x300	500	520	540	300	320	340	375	630	24.2
PR 600x300	600	620	640	300	320	340	375	730	31.0
PR 600x350	600	620	640	350	370	390	425	730	33.4
PR 700x400	700	720	740	400	420	440	475	830	47.8
PR 800x500	800	820	840	500	520	540	575	930	61.1
PR 900x500	900	920	940	500	520	540	575	1130	78.8
PR 1000x500	1000	1020	1040	500	520	540	575	1130	78.3

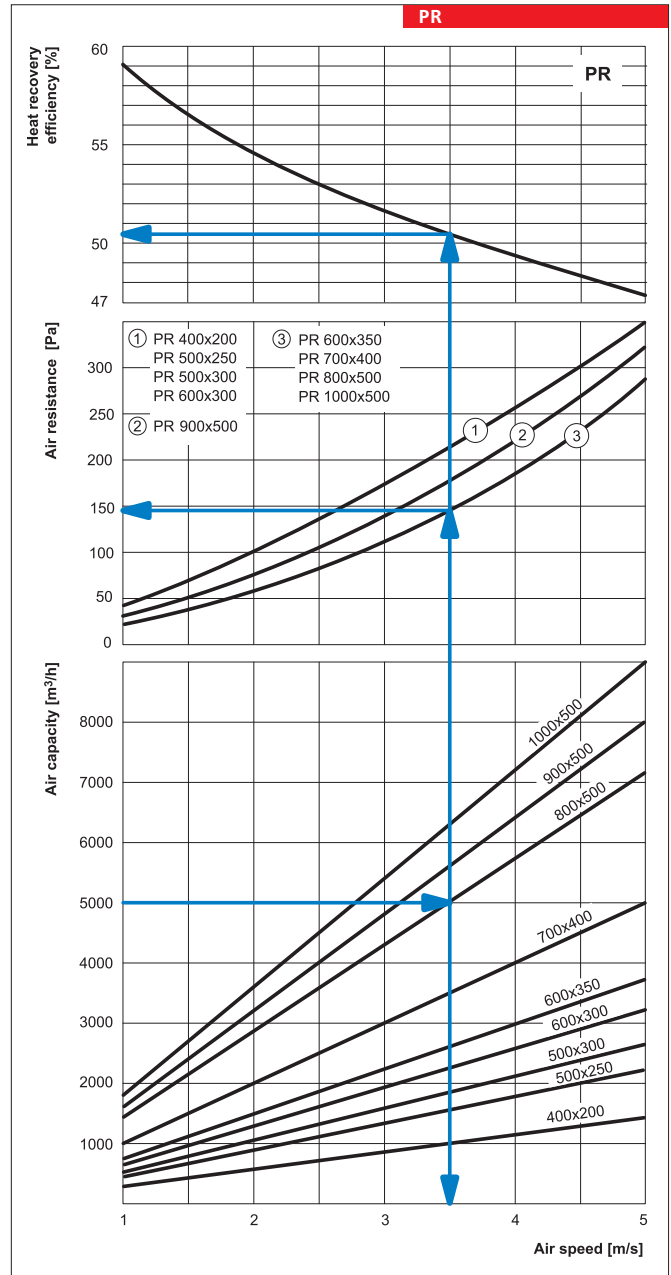

Series
FBK



■ **Applications**

Bag type air filters are applied for supply air and sometimes for exhaust air purification in rectangular duct ventilating and conditioning systems. They serve to protect air ducts, heat exchangers, control equipment and other ventilating equipment against dusting. The filters minimize wall and ceiling pollution near the air diffuser. Coarse filters can be used as first stage purification filters before more efficient filters.

■ **Design**

The casing is made of galvanized steel. The swing-out cover equipped with lever locks provides easy and quick access to the replaceable filtering element. The pocket-type filtering element is made of non-woven synthetic fibrous fabric and is fixed on the steel frame. The filters are available in G4, F5, F7 filtering classes.

■ **Mounting**

Mounting is performed by means of flange connection. The air flow direction shall match the pointer direction on the filter. Both horizontal and vertical installation is possible. In case of vertical installation the air shall be streamed downwards in such a way as to avoid the bag crumpling. Access for the fan maintenance shall be provided for the filter cleaning or replacement.

Overall dimensions:

Type	Dimensions [mm]							Weight [kg]
	B	B1	B2	H	H1	H2	L	
FBK 400x200	400	420	440	200	220	240	500	6.2
FBK 500x250	500	520	540	250	270	290	600	7.8
FBK 500x300	500	520	540	300	320	340	600	8.3
FBK 600x300	600	620	640	300	320	340	600	8.9
FBK 600x350	600	620	640	350	370	390	600	9.5
FBK 700x400	700	720	740	400	420	440	720	16.2
FBK 800x500	800	820	840	500	520	540	800	20.4
FBK 900x500	900	920	940	500	520	540	800	21.7
FBK 1000x500	1000	1020	1040	500	570	540	800	23.5

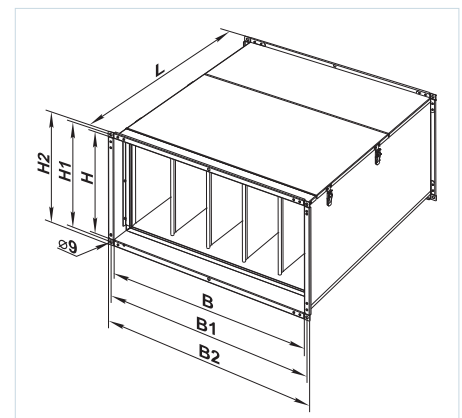

Designation key:

Series	Flange dimensions (WxH) [mm]	Filtering class	Replaceable filter SFK
FBK SFK	400x200; 500x250; 500x300; 600x300; 600x350; 700x400; 800x500; 900x500; 1000x500	4 – G4 5 – F5 7 – F7	

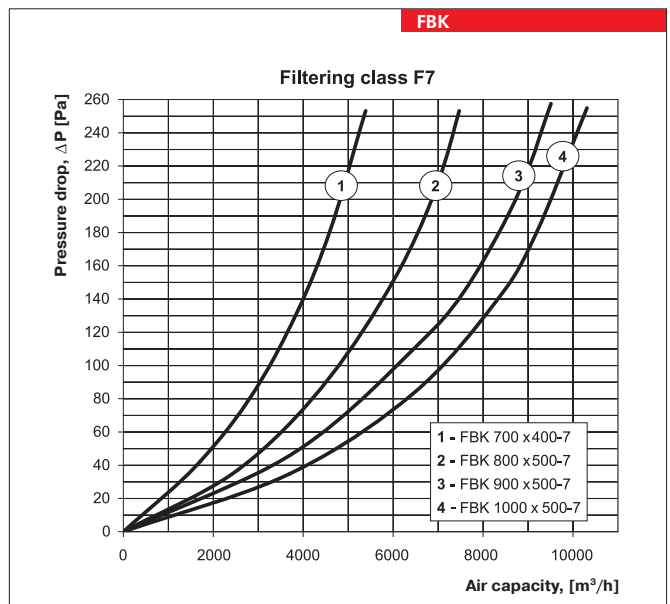
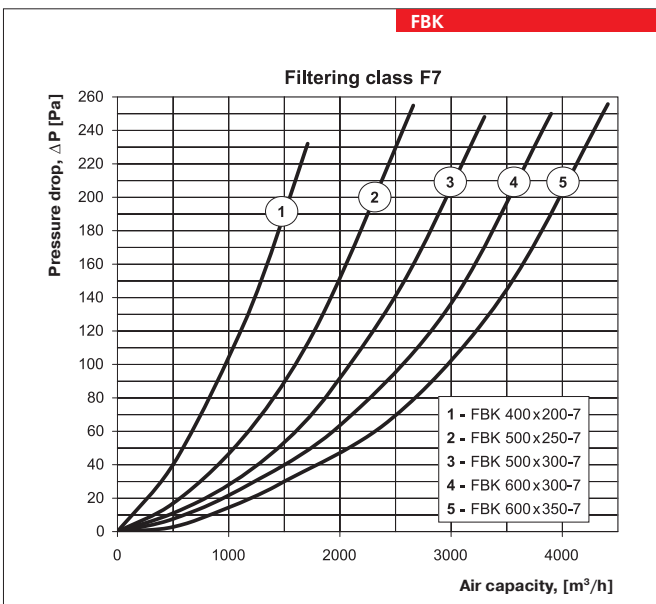
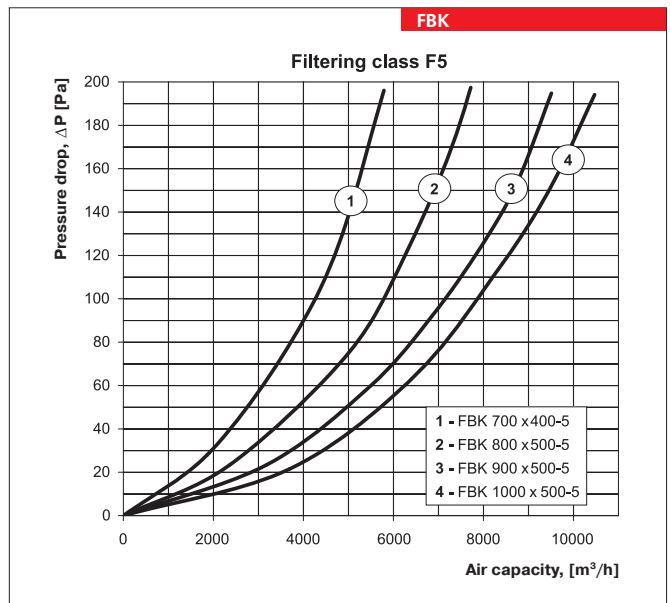
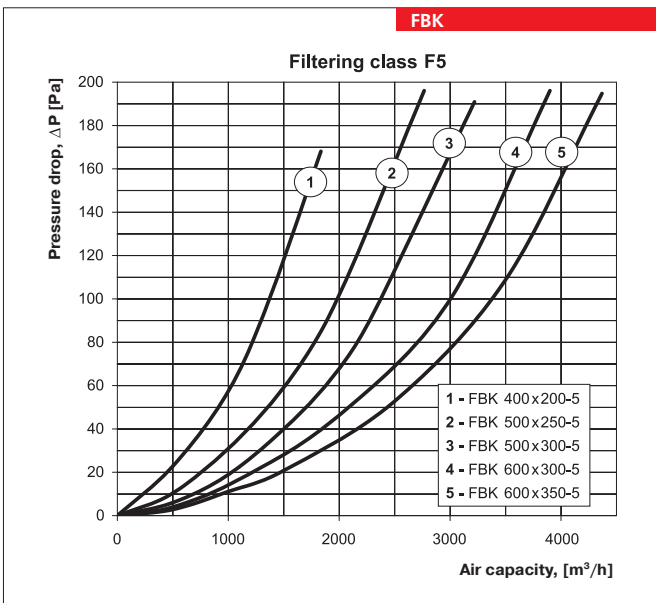
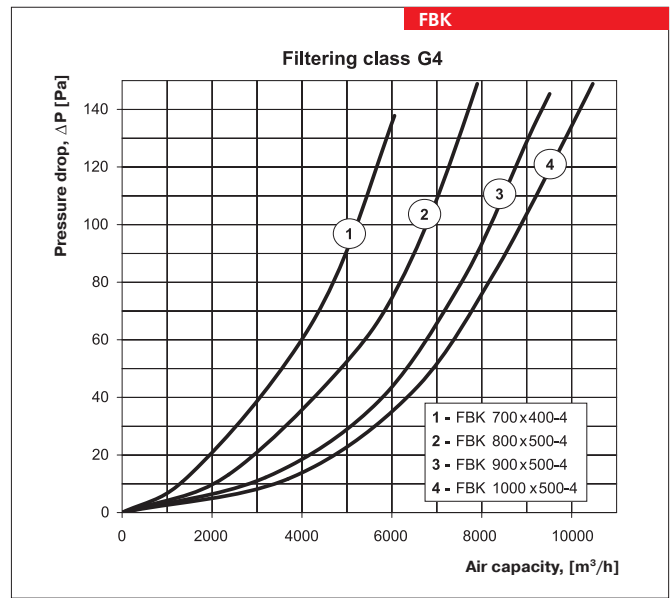
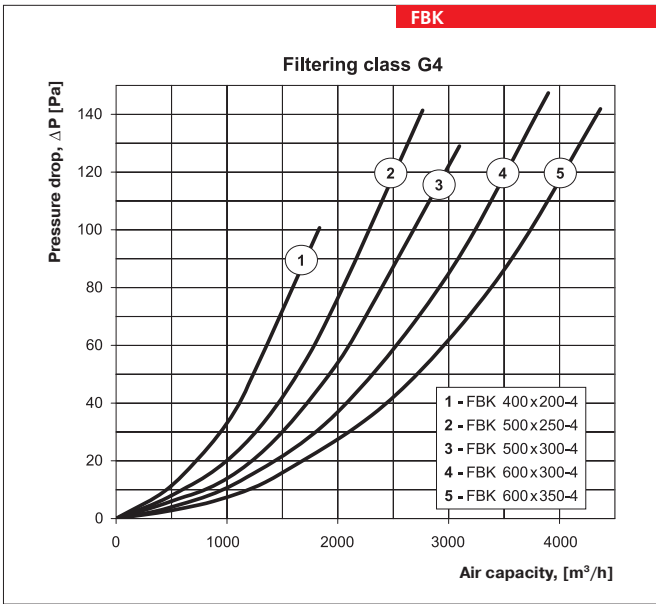

Series
FB



■ **Applications**

Panel type air filters are applied for supply air and sometimes extract air purification in rectangular duct ventilating and conditioning systems. Designed for protection of the air ducts, heat exchangers, control equipment and other ventilating equipment against dusting. The filters minimize wall and ceiling pollution near the air diffuser. Coarse filters can be used as first stage purification filters before more efficient filters.

■ **Design**

The casing is made of galvanized steel. V-shaped form ensures filtering surface increase. The filtering

element is made of non-woven fabric from synthetic fibers and has protecting metal mesh against deformation caused by air flow. Removable cover equipped with lever locks provides easy and quick access to the replaceable filtering element. The filters are small-sized and are suitable even for limited space. Filtering class G4.

■ **Mounting**

The filters are installed at heater and fan inlet along the air flow direction. The air flow direction shall match the designation on the filter. Access for the fan maintenance shall be provided for the filter cleaning or replacement.

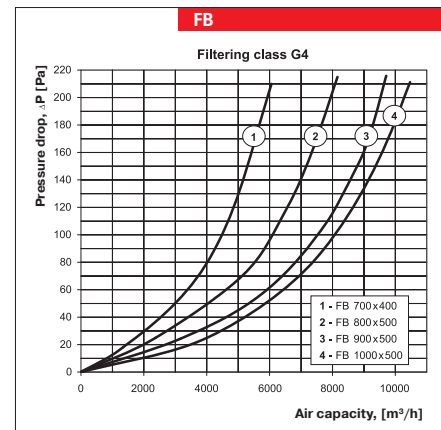
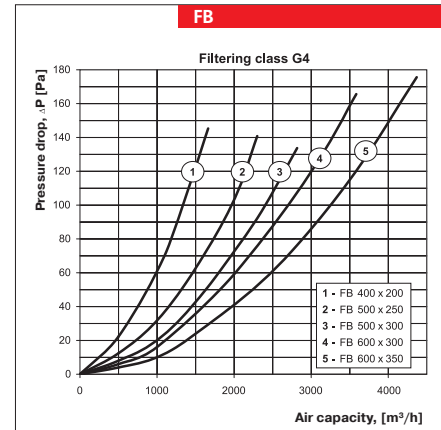

Overall dimensions:

Type	Dimensions [mm]						Weight [kg]
	B	B1	B2	H	H1	H2	
FB 400x200	400	420	440	200	220	240	2.4
FB 500x250	500	520	540	250	270	290	4.1
FB 500x300	500	520	540	300	320	340	4.4
FB 600x300	600	620	640	300	320	340	5.2
FB 600x350	600	620	640	350	370	390	5.8
FB 700x400	700	720	740	400	420	440	6.7
FB 800x500	800	820	840	500	520	540	7.9
FB 900x500	900	920	940	500	520	540	8.4
FB 1000x500	1000	1020	1040	500	520	540	8.9

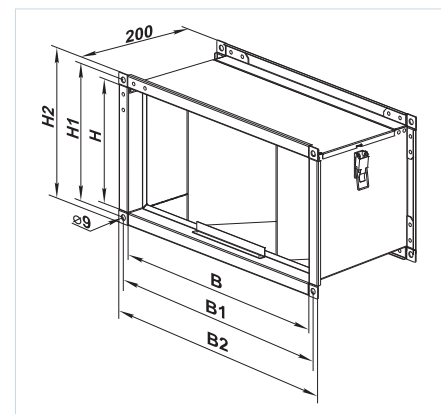

Designation key:

Series	Flange dimensions (WxH) [mm]
FB SF	400x200; 500x250; 500x300; 600x300; 600x350; 700x400; 800x500; 900x500; 1000x500

Replaceable SF filter



FLEXIBLE ANTI-VIBRATION CONNECTORS

Series
VVG



■ **Applications**

Flexible connectors are designed to exclude the vibration transmission from fans or ventilating units to the air duct as well as for the thermal distortion compensation within the air duct. Applied in ventilation systems with the transferred air temperature over the range of -40 °C to +80 °C.

■ **Design**

Flexible connectors are two flanges made of galvanized sheet steel interconnected by vibration-isolating material made of polyethylene tape reinforced with polyamide fiber. The connectors are not designed for mechanical load and cannot be used as a part of load-bearing construction.

■ **Mounting**

Mounting of flexible connector into the ventilation system is effected by means of end flanges fixing to the mating flanges in the ventilation system. Fixing is performed by means of galvanized bolts and brackets.

Overall dimensions:

Type	Dimensions [mm]						Weight [kg]
	B	B1	B2	H	H1	H2	
VVG 400x200	400	420	440	200	220	240	1.1
VVG 500x250	500	520	540	250	270	290	1.4
VVG 500x300	500	520	540	300	320	340	1.6
VVG 600x300	600	620	640	300	320	340	1.82
VVG 600x350	600	620	640	350	370	390	1.95
VVG 700x400	700	720	740	400	420	440	2.4
VVG 800x500	800	820	840	500	520	540	2.8
VVG 900x500	900	920	940	500	520	540	3.0
VVG 1000x500	1000	1020	1040	500	520	540	3.2

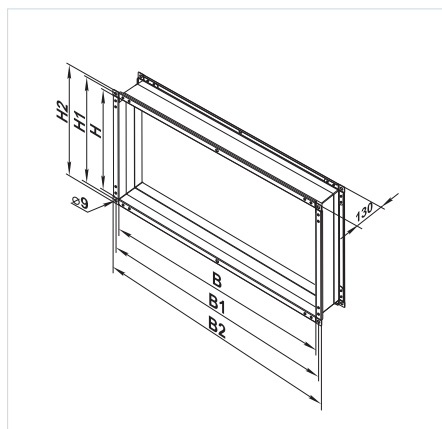

Designation key:

Series	Flange dimensions (WxH) [mm]
VVG	400x200; 500x250; 500x300; 600x300; 600x350; 700x400; 800x500; 900x500; 1000x500

Single phase speed controller
RSA5E-2-P



Speed control enables not only selecting the comfortable ventilation mode for the periodically visited premises but reducing the energy consumption for the ventilation.

■ **Applications**

RSA5E-2-P series speed controller is applied for air capacity control of single phase fans by means of step control of motor speed. The controller has five speeds. Speed is set by means of rotating the control knob at the casing front panel. Several fans can be controlled synchronously in case their total consumption current does not exceed the maximum permissible value of the controller current.

■ **Design**

The controller casing is made of flame-retardant thermoplastic. The controller has five speeds with the output power 110V-130V-160V-190V-230V and incorporates ON/OFF button with pilot light, the control knob for speed switching and the emergency operation LED indicator. The integral motor protection device is included which cuts the supply voltage to the fan if the thermal contact in the fan motor is activated.

After the temperature drops to the operating level the motor restarts.

The controller has the following supplementary functions:

- ▶ terminals for connection to the room thermostat or to the thermostat for the icing protection. In case of the circuit breaking the power supply to the motor is disabled;
- ▶ terminals of 230 V, max. 2A for connection and controlling such external equipment actuator driven air damper;
- ▶ provision for remote speed control (refer the connection options).

■ **Mounting**

The controller is designed for indoor mounting. Installation shall be performed with respect to the free air recirculation for inner circuit cooling.

Technical data:

	RSA5E-2-P
Voltage [V/50 Hz]	1~ 230
Rated current [A]	2.0
Overall dimensions LxWxH [mm]	222x120x100
Maximum ambient temperature [°C]	40
Protection rating	IP 54
Weight [kg]	3.1

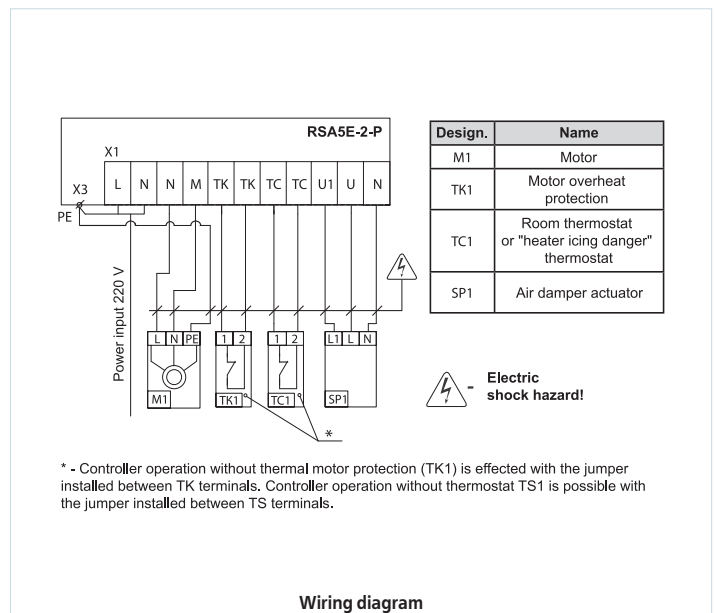
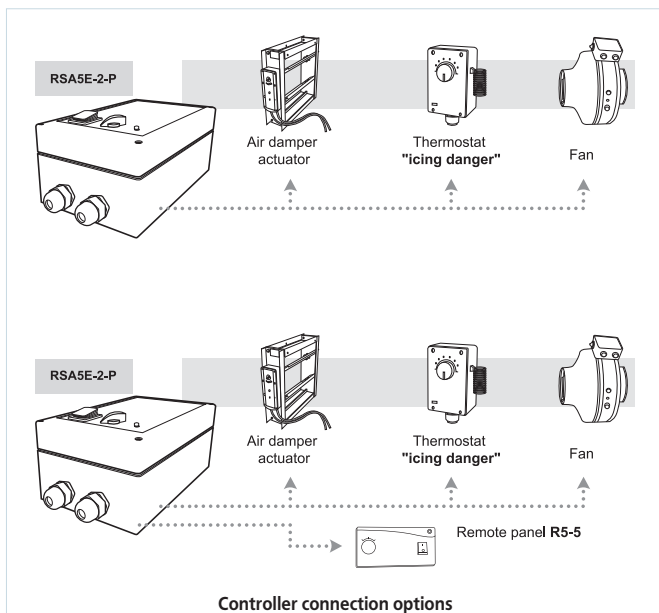

* - Controller operation without thermal motor protection (TK1) is effected with the jumper installed between TK terminals. Controller operation without thermostat TS1 is possible with the jumper installed between TS terminals.

Single phase speed controller RSA5E-...-M



Speed controls enables not only selecting the comfortable ventilation mode for the periodically visited premises but reducing the energy consumption for the ventilation.

■ Applications

RSA5E-...-M series speed controllers are applied for air capacity control of single phase fans by means of step speed control. The controller has five speeds. Speed is set by means of rotating the control knob at the casing front panel. Several fans can be controlled synchronously in case their total consumption current does not exceed the maximum permissible value of the controller current.

■ Design and control

Casing is made of steel with polymeric coating. The controller has five speeds with the output power 110V-130V-160V-190V-230V (for RSA5E-12-M modification-80V-105V-130V-160V-230V). The controller incorporates ON/OFF button with pilot light, control knob for speed switching and controller emergency operation LED indicator.

■ Protection

The integral motor protection device is included which cuts the supply voltage to the fan if the thermal contact in the fan motor is activated. After the temperature drops to the operating level the motor restarts.

The controller has the following supplementary functions:

- ▶ terminals for connection to the room thermostat or to the icing protection thermostat. In case of the circuit breaking the power supply to the motor is cut.
- ▶ terminals of 230 V, max. 2A/3A/4A for connection and controlling such external equipment as actuator driven air damper.
- ▶ provision for remote speed control (refer the connection options).

■ Mounting

The controller is designed for indoor mounting. Installation shall be performed with respect to the free air circulation for inner circuit cooling.

Technical data:

	RSA5E-2-M	RSA5E-3-M	RSA5E-4-M	RSA5E-12-M
Voltage, [V/50 Hz]	1~ 230	1~ 230	1~ 230	1~ 230
Rated current [A]	2.0	3.0	4.0	12.0
Overall dimensions LxWxH [mm]	226x144x120	241x164x138	241x184x132	325x250x245
Maximum ambient temperature [°C]	40	40	40	40
Protection rating	IP 21	IP 21	IP 21	IP 44
Weight [kg]	3.4	4.1	4.5	4.5

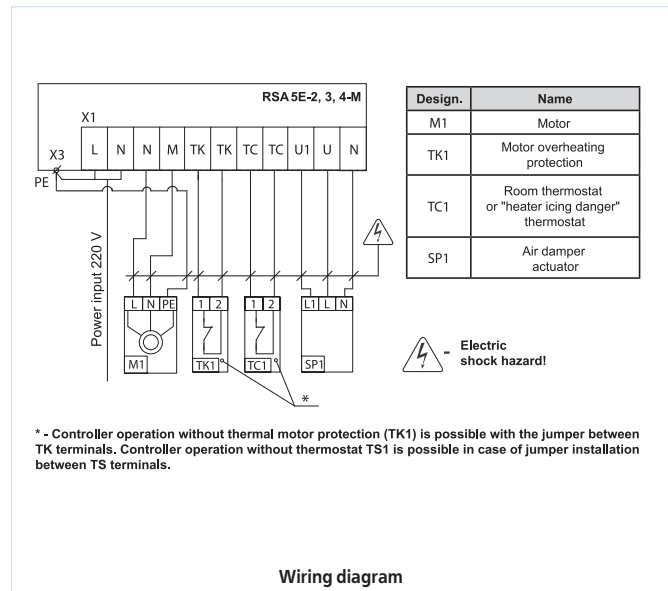
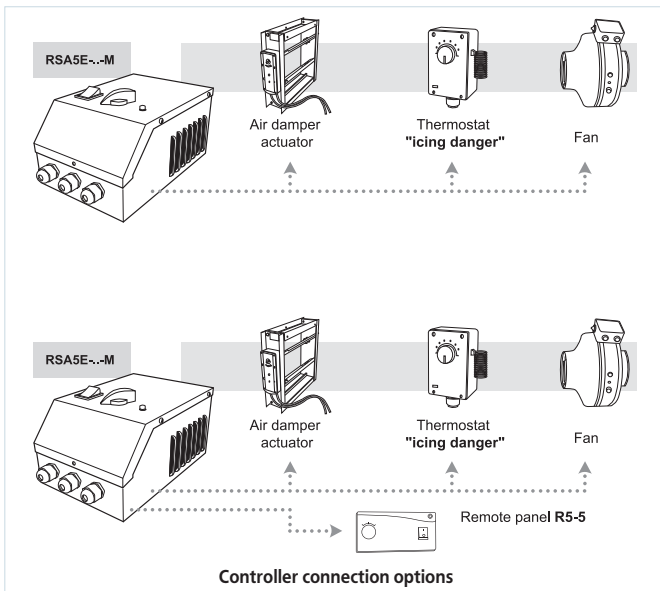

Single phase speed controller
RSA5E-...-T



■ **Applications**

RSA5E-...T series speed controllers are applied for air capacity control of single phase fans by means of motor step speed control. The controllers have five speeds. Speed is set by means of rotating the control knob at the casing front panel to one of five available fixed positions. Several fans can be controlled synchronously in case their total consumption current does not exceed the maximum permissible value of the controller current.

■ **Design and control**

The controller casing is made of flame-retardant thermoplastic. The controller has five speeds with the output power 80V - 105V - 130V - 160V - 230V and incorporates ON/OFF pilot light for operation indication, control knob for speed switching and controller emergency operation LED indicator.

The integral motor protection device is included which cuts the supply voltage to the fan if the thermal contact in the fan motor is activated. After the temperature drops to the operating level the motor restarts.

The controller has the following supplementary functions:

- ▶ terminals of 230 V, max. 2A for connection and controlling such external equipment as actuator driven air dampers.

■ **Mounting**

The controller is designed for indoor mounting. Installation shall be performed with respect to the free air recirculation for inner circuit cooling. The controller is for vertical installation. Do not install the controller above the heaters and in bad air convection areas.

Technical data:

	RSA5E-1,5-T	RSA5E-3,5-T	RSA5E-5,0-T	RSA5E-8,0-T	RSA5E-10,0-T
Voltage [V/50 Hz]	1~ 230	1~ 230	1~ 230	1~ 230	1~ 230
Rated current [A]	1.5	3.5	5.0	8.0	10.0
Overall dimensions LxWxH [mm]	205x110x85	255x170x140	255x170x140	305x200x180	305x200x180
Maximum ambient temperature [°C]	+5...+35	+5...+35	+5...+35	+5...+35	+5...+35
Protection rating	IP 44	IP 44	IP 44	IP 44	IP 44

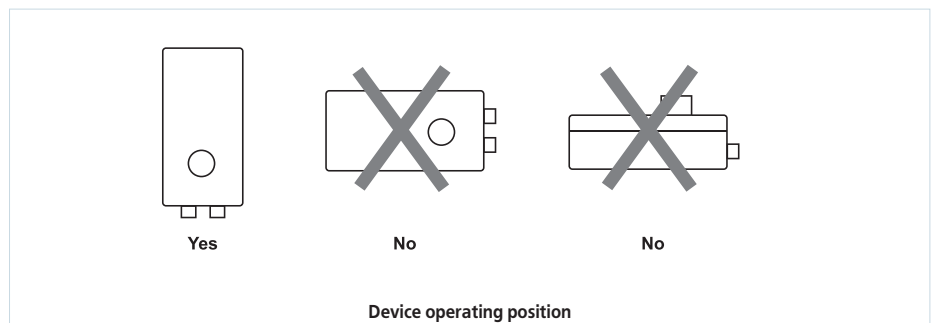
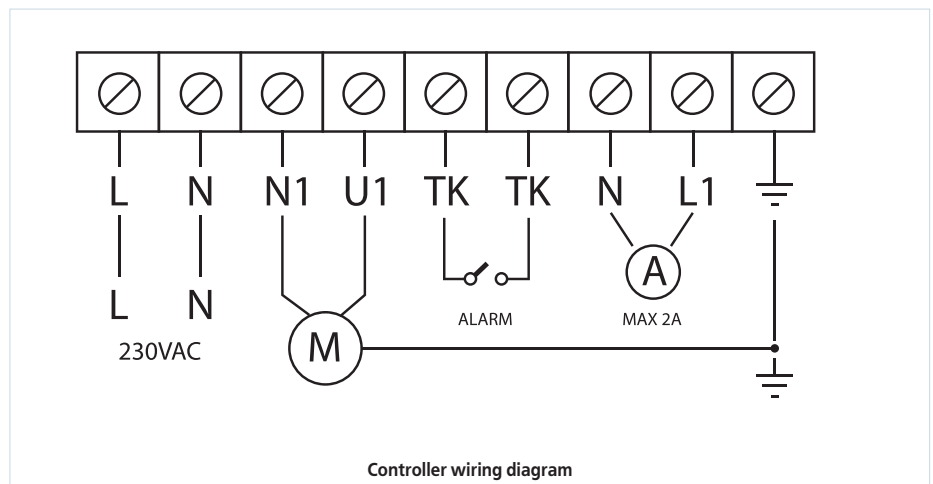

Three phase speed controller RSA5D-...-T



Applications

RSA5D-...T series speed controllers are applied for air capacity control of three phase fans by means of step speed control. The controllers have five speeds. Speed is set by means of rotating the control knob at the casing front panel to one of five available fixed positions. Several fans can be controlled synchronously in case their total consumption current does not exceed the maximum permissible value of the controller current.

Design and control

The controller casing is made of flame-retardant thermoplastic. The controller has five speeds with the output power 90V - 150V - 200V - 280V - 400V and incorporates control speed knob, pilot light and controller emergency operation LED indicator.

The integral motor protection device is included which cuts the supply voltage to the fan if the thermal contact in the fan motor is activated. After the temperature drops to the operating level the motor restarts.

As supplementary functions the controller is fitted with terminals of 230 V, max. 2A for connection and controlling such external equipment as actuator driven air damper.

Mounting

The controller is designed for indoor mounting. Installation shall be performed with respect to the free air recirculation for inner circuit cooling. The controller is for vertical installation. Do not install the controller above the heaters and in bad air convection areas.

Technical data:

	RSA5D-1,5-T	RSA5D-3,5-T
Voltage, [V/ 50 Hz]	3~ 400	3~ 400
Rated current [A]	1.5	3.5
Overall dimensions LxWxH [mm]	305x200x180	305x200x180
Maximum ambient temperature [°C]	+5...+35	+5...+35
Protection rating	IP 44	IP 44

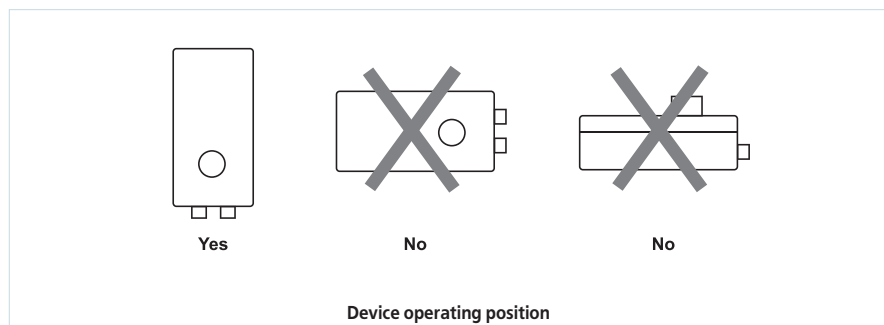
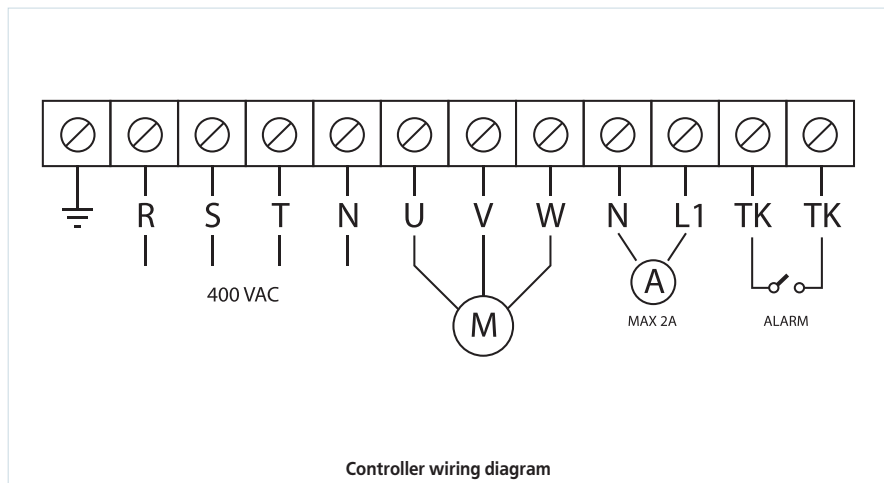

Three phase speed controller
RSA5D-...-M



■ **Applications**

RSA5D-...M series speed controllers are applied for air capacity control of three phase fans by means of step control of motor speed. The controllers have five speeds. Speed is set by means of rotating the control knob at the casing front panel to one of five available fixed positions. Several fans can be controlled synchronously in case their total consumption current does not exceed the maximum permissible value of the controller current.

■ **Design and control**

The controller casing is made of flame-retardant thermoplastic. The controller has five speeds with the output power 90 V - 150 V - 200 V - 280 V - 400 V and incorporates control speed knob, light indication

for operation and pilot lamp to indicate the emergency operation of the controller. The controller has built-in motor overheating protection which cuts power supply in case of exceeding the set temperature threshold. After the temperature drops to the operating level the motor restarts.

The controller is fitted with 230 V terminals, max. 2 A for connection and controlling such external equipment as actuator driven air damper.

■ **Mounting**

The controller is designed for indoor mounting. Installation shall be performed with respect to the free air recirculation for inner circuit cooling. The controller is for vertical installation. Do not install the controller above the heaters and in bad air convection areas.

Technical data:

	RSA5D-5,0-M	RSA5D-8,0-M	RSA5D-10,0-M	RSA5D-12,0-M
Voltage [V/ 50 Hz]	3~ 400	3~ 400	3~ 400	3~ 400
Rated current [A]	5.0	8.0	10.0	12.0
Overall dimensions LxWxH [mm]	325x250x245	325x250x245	425x300x250	425x300x250
Maximum ambient temperature [°C]	+5...+35	+5...+35	+5...+35	+5...+35
Protection rating	IP 44	IP 44	IP 44	IP 44

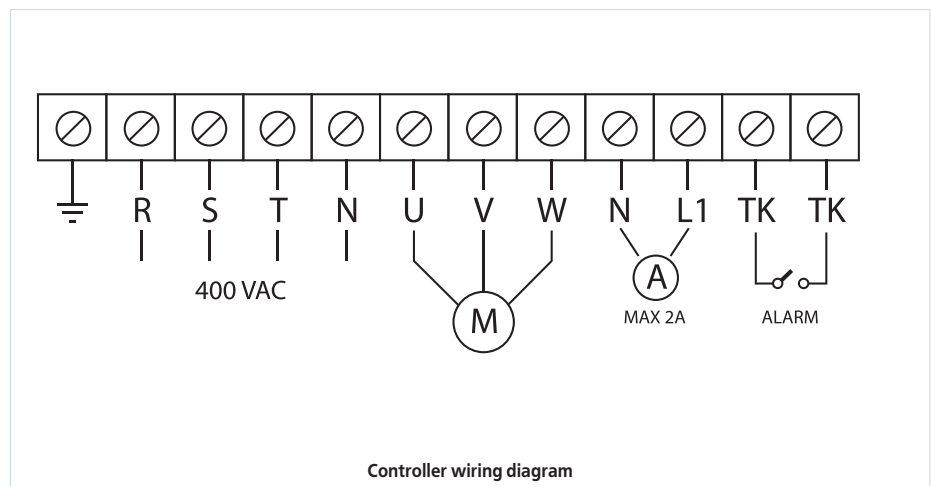

Controller wiring diagram

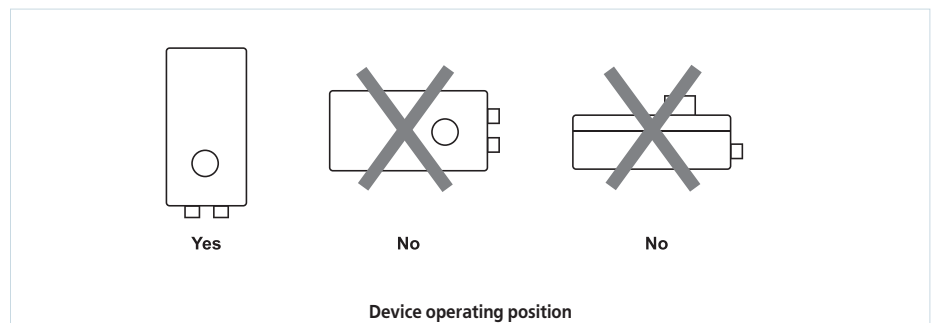

Device operating position

Temperature regulator RTS -1- 400 RTSD -1- 400



■ Applications

Applied for temperature mode control in ventilation, heating and air conditioning systems. Can be applied for control of fans and fancoil valves, air heating units with 230 V three speed fans. Automatic heating or cooling rate control.

■ Design and control

The temperature sensor is built into the plastic control panel casing. A digital light-up LCD display and control knobs are located at the control face panel. The display shows the current and set indoor air temperature, selected mode for cooling, heating or automatic mode as well as set motor speed. The rotation speed can be adjusted manually by means of control knob rotation. Provision is made for automatic control of rotation speed (quick/medium/low) depending on the indoor temperature.

- ▶ The light-up display enables the regulator operation in bad light conditions.
- ▶ Temperature maintaining within up to 1 °C.
- ▶ Saving settings at no power supply.
- ▶ RTSD-1-400 model is equipped with remote control panel.
- ▶ Night duty operation (refer to operation mode for night duty below).

■ Mounting

Control panel is designed for indoor surface mounting. The recommended installation height is 1.5 m. Do not install the control panel close to windows, doors, heating or cooling devices. The controller is designed for indoor mounting into special flush mounting junction box MKV-1 (under separate order).

Technical data:

	RTS-1-400	RTSD-1-400
Voltage [V / 50/60 Hz]	1~ 230	1~ 230
Rated current [A]	2.0	2.0
Number of selected speeds	3	3
Temperature adjustment range [°C]	+10...+30	+10...+30
Overall dimensions LxWxH [mm]	88x88x51	88x88x51
Maximum ambient temperature [°C]	40	40
Protection rating	IP 40	IP 40
Remote control panel	no	yes

NIGHT DUTY OPERATION peculiarities

- ▶ **Operation of the temperature regulator in the heating mode:** in 30 minutes after switching to the night duty the indoor temperature goes automatically down by 1 °C and in 1 hour the temperature goes down by 1 °C more. One hour later the temperature goes down by 1 °C more and it is kept on this level within 8 hours. After switching the timer off the temperature resets to the initial point automatically.
- ▶ **Operation of the temperature regulator in cooling mode:** in 30 minutes after switching to the night duty the indoor temperature goes automatically up by 1 °C and in 1 hour the temperature goes up by 1 °C more and it is kept on this level 8 hours. After switching the timer off the temperature resets to the initial point automatically.

Pressostat
DTV 500



■ Application

The pressure differential switch is used to determine air rarefaction or air (non-aggressive gases) pressure drop. It is used in ventilation systems to determine air filter clogging degree or belt breaking in centrifugal fans, etc.

■ Design and control

The pressostat switch is made of plastic. The pressure differential for the pressure switch actuation is set by turning the disk in the casing. The delivery set includes 2 plastic pressure outlets for pressure tap-off, PVC tubes Ø 5 mm and 2 m long.

■ Mounting

The pressure switch is designed for surface wall mounting or installation into air ducts on the mounting bracket with two Ø 5 mm openings located at 40 mm center-to-center distance. The switch is suitable both for vertical and horizontal installation. However vertical orientation is preferable because in case of horizontal orientation the switching point will be shifted for 11 Pa. The length of pressure outlet tubes is variable but the relay actuation time increases if the tube length is above 2 m. Install the differential pressure switch above the pressure tapping points. Connect the tubes in such a way as to avoid formation of tubular loops to prevent condensate accumulation inside the tubes.

Technical data:

	DTV 500
Number of contacts	1
Contact data [A]	5 (0.8) 250 V AC
Reset mechanism	changeover
Pressure range [Pa]	50...500
Hysteresis loop	25 Pa +/- 8 Pa
Protection rating	IP 54

Pressostat wiring diagram

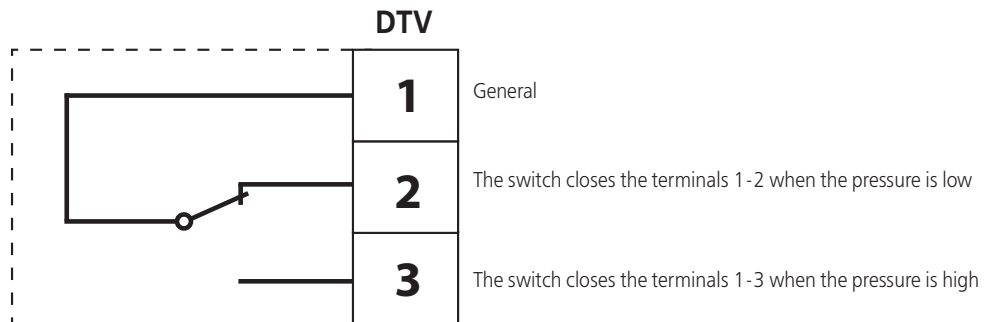

Overall dimensions:

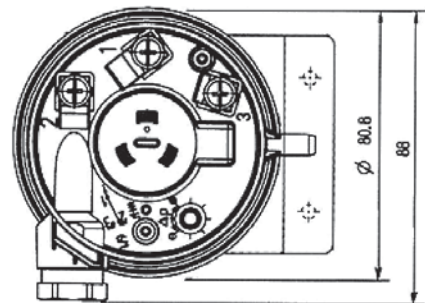
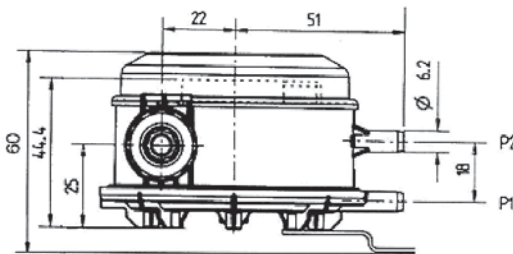

P1 connector for high pressure
P2 connector for low pressure

Thermostat F-3000



■ Application

The thermostats with bridging contacts are designed for regulation of air temperature, temperature of liquids and gases and are widely used in electric water heaters, dishwashing and clothe washing machines, drying machines, electric furnaces, etc. The thermostat is used to prevent freezing of water heaters and heat exchangers according to exhaust air temperature readings.

■ Design and control

The operating logic is based on volumetric thermal extension. The thermostatic bulb is located in the copper sleeve. Liquid placed inside the thermostatic bulb is heated, expanded and its excessive volume is transferred through the capillary tube to the bellows.

The bellows are elongated and transmit force to the relay contact. Thus the set temperature is maintained in the system. The thermostat casing is made of plastic. The temperature probe is made of copper. The response temperature is set by rotation of the disk in the casing.

■ Mounting

The thermostat is suitable for wall surface mounting or installation in the duct in any position. The casing is fixed to the surface with screws on the front panel. The thermostatic bulb is designed for operation in temperature-controlled environment. The thermostat is connected with the thermal bellows with 1.5 m long capillary tube.

Technical data:

	F-3000
Relay switching capacity	16A 230 V (active load)
Length of the capillary tube [m]	1.5
Operating temperature range [°C]	-30 up to +30
Reset mechanism	changeover
Operating pressure range [Pa]	50...500
Number of contacts	1 per switch
Protection rating	IP 54

Thermostat wiring diagram

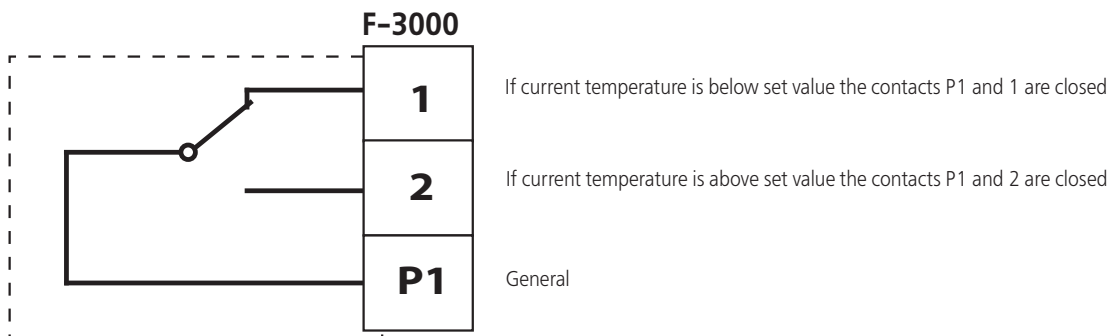

TRIAC power controller
for electric heaters
RNS



■ **Applications**

Applied in ventilation systems for regulating the power output of electric heaters with load current rating up to 120 A.

■ **Design and control**

The controller casing is made of flame-retardant thermoplastic. The controller is equipped with an ON/OFF button and a heating temperature control knob. Electric power output is regulated by proportional connection and disconnection of the full load depending on the pre-set heating temperature. The RNS-16 is capable of controlling only one heating stage. Unlike the smaller models, RNS-25 are capable of controlling one or three heating stages with the power output equal or exceeding that of the controlled stage. The power output of the first stage is controlled steplessly by switching the full load on and off. The second and third stages are controlled in steps. For overheating protection the electric heater must be equipped with two built-in thermal contacts: TK50 with intervention temperature of +50 °C and automatic restarting and TK90 with response temperature of +90 °C and

manual restarting. The air temperature is set by means of the built-in potentiometer or the external control device generating a 0-10 V control input for increasing the duct temperature proportionally in the range from 0 to +40 °C. The duct temperature sensor must be installed downstream of the heater in the direction of the air stream at the minimum distance of 50 cm from the heater. If the controller runs in the heating power output mode in disregard of the temperature sensor feedback, no duct temperature sensor is necessary whereas the heating power output is regulated in the 0 to 100% range by means of the 0-10 V control signal.

■ **Protection**

Input circuit of the power controller has a thermal fuse for overload protection.

■ **Mounting**

The controller is designed for indoor mounting. Installation shall be performed with respect to the free air circulation for inner circuit cooling. The controller is for vertical installation. Do not install the controller above the heaters and in bad air convection areas.

Technical data:

	RNS-16	RNS-25
Max. load current (single stage) [A]	25	40
Heater power (single stage) [kW]	16	25
Max. load current (three stages) [A]	–	120
Heater power (three stages) [kW]	–	75
Control circuit supply voltage	~230 V / 50 Hz	
Nominal current of control circuit board fuse [A]	0.1	
Cross-section area of screw terminal block input pin [mm ²]	4...10	
Protection rating	IP 54	
Overall dimensions [mm]	170x255x140	
Weight [kg]	1.2	
Mains parameters:		
• voltage [V]	210-255, 380-415	
• frequency [Hz]	50-60	
• phases	1 or 3	
Operating temperature range [°C]	+5...+40	

Note: heat generated by the RNS-10 and RNS-16 controllers themselves is 50 W, by the RNS-25 controller – 80 W.

Control parameters	
Regulation time [s]	0.1 (fixed)
Cycle length [s]	1...10 (adjustable)
Indication	Power, operation and malfunction indicator
Type of temperature sensor used	LM 60
Input signal parameters [V]	0...10 (direct current)
Set temperature range [°C]	0...40 (adjustable)

External connections diagram

Attention!
THE CONTROLLER IS INTENDED
FOR VERTICAL MOUNTING ONLY!

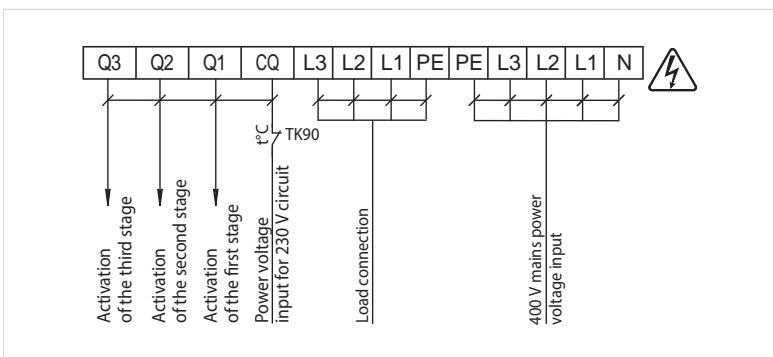
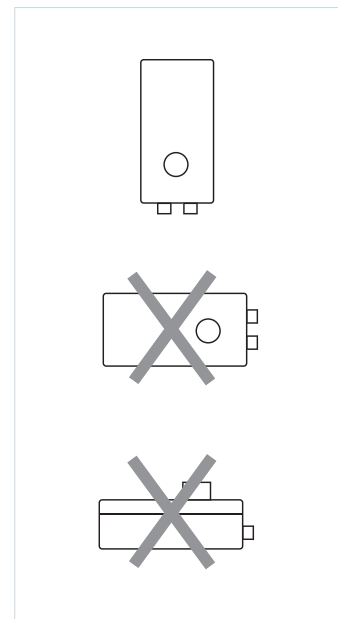
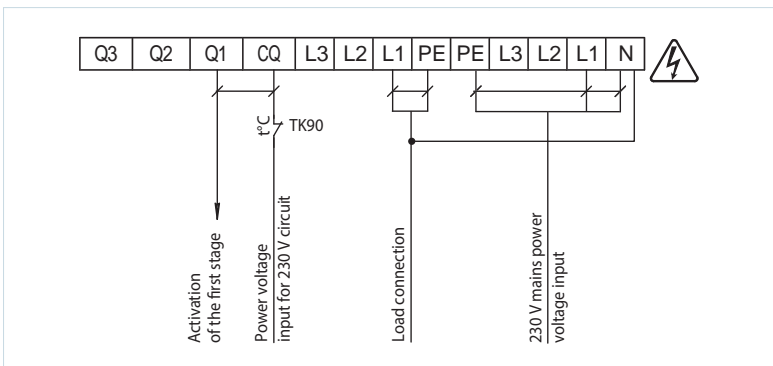

Control unit wiring diagrams

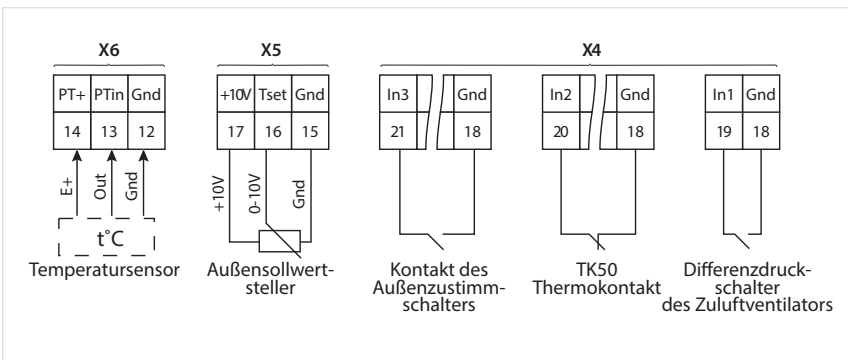

Electric triac temperature controllers for single and two-phase electric heaters

PULSER-M



Application

The triac controller **PULSER-M** is designed for control of electric heaters power output. The controller design allows connecting to single or two phase heater.

Design and control

PULSER-M is equipped with a built-in temperature controller for indoor temperature control and external main sensor as well as input terminals for connection of the built-in temperature sensor that can be used as a main sensor and the

sensor for minimum and maximum limitations. The temperature controller selects required voltage automatically depending on 230 or 400 V operation. P or PI control law is selected automatically. Temperature setting range depends on the used temperature sensor, refer temperature sensors TG-K.

Mounting

The controller is designed for mounting on the vertical level surface between power supply and the electric heater.

Technical data

	PULSER-M
Maximum load current	16 A (3400/6000 W)
Voltage [V]	230/400
Pulse period	60 s
Overall dimensions [mm]	94x150x43
Weight [kg]	0.300
Protection rating	IP 20

Wiring diagrams

Connection to electric heater and power mains

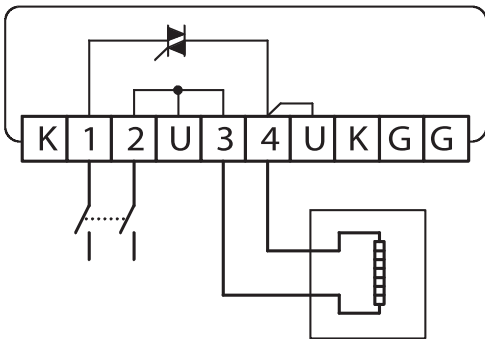

Built-in sensor and settings

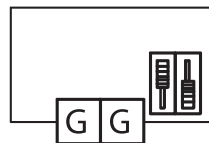

Connection of external sensors

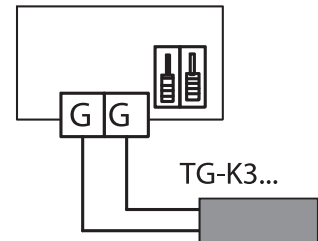

Connection of the sensor for minimum temperature

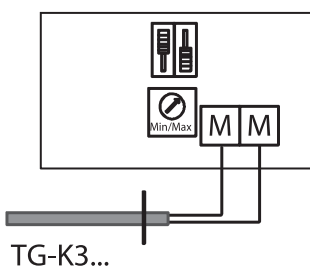

Connection of the sensor for maximum temperature

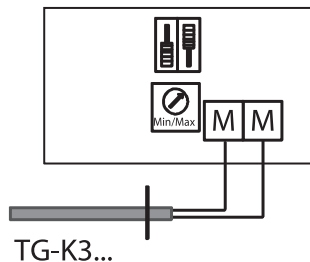

Connection for night set-back

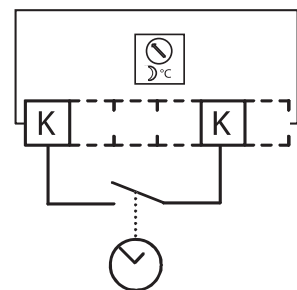

Duct temperature sensors KDT-M / KDT-M1



■ Application

The duct temperature sensors are designed for installation in the air duct and temperature measurement of the air flow in the ventilation and air conditioning systems.

■ Design

The sensing element, NTC thermometer resistor, is enclosed in the aluminium sleeve. The thermometer resistor electric resistor depends on the temperature, the non-linear resistance. Connection of the sensor to

the controller is double-wired, regardless of polarity.

The KDT-M sensor delivery set includes a mounting flange with a fixing screw for its fixation to the air duct wall. The sensors are supplied with a 2.5 m connecting cable. The immersion depth is adjusted for 100, 150, 200 or 400 mm.

■ Mounting

Fixation with screws to the air duct wall by means of the flange with the sensing element located the air stream.

Technical data:

	KDT-M / KDT-M1
Temperature measuring range [°C]	-30...+80
Voltage [V]	≤ 5 DC*
Output	resistance
Electric connection	double-wire, cross section 2x0.25 mm ²
Relative humidity	up to 90%, no condensation
Protection rating	IP 54
Electrical appliance class	III

*Maximum current generated through the sensor by the applied voltage is 2 mA.

Overall dimensions:

Type	L [mm]
KDT-M 100 / KDT-M1 100	100
KDT-M 150 / KDT-M1 150	150
KDT-M 200 / KDT-M1 200	200
KDT-M 400 / KDT-M1 400	400

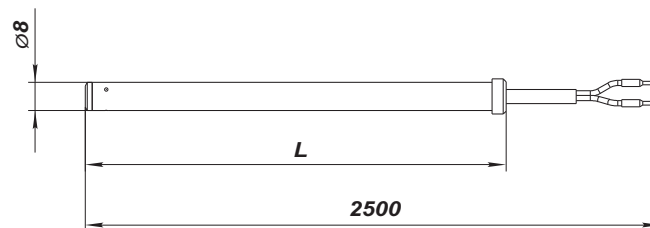

KDT-M1 duct temperature sensor

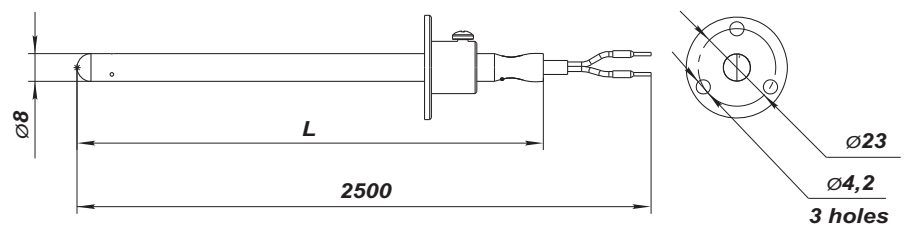

KDT-M duct temperature sensor

Duct temperature sensors KDT2-M / KDT2-M1



■ Application

The duct temperature sensors are designed for installation in the air duct and temperature measurement of the air flow in the ventilation and air conditioning systems.

■ Design

The sensor consists of the integrated circuit chip located inside the plastic casing. This sensor type has a linear transfer characteristics of output voltage to temperature and a three-wire connection to power mains.

This sensor type is not compatible with resistance sensors. During electric connections the polarity of the outputs connected to the inputs of the air

handling units must be considered.

The KDT-M sensor delivery set includes a mounting flange with a fixing screw for its fixation to the air duct wall.

The KDT-M sensor delivery set includes a mounting flange with a fixing screw for its fixation to the air duct wall. The sensors are supplied with a 2.5 m connecting cable. The immersion depth is adjusted for 100, 150, 200 or 400 mm.

■ Mounting

Fixation with screws to the air duct wall by means of the flange with the sensing element located the air stream.

Technical data:

	KDT2-M / KDT2-M1
Temperature measuring range [°C]	-30...+80
Voltage [V]	2,7...10
Output resistance [Ohm]	800
Electric connection	three-wire, cross section 2x0.25 mm ²
Relative humidity	up to 90%, no condensation
Protection rating	IP 54
Electrical appliance class	III

Overall dimensions

Type	L [mm]
KDT2-M 100 / KDT2-M1 100	100
KDT2-M 150 / KDT2-M1 150	150
KDT2-M 200 / KDT2-M1 200	200
KDT2-M 400 / KDT2-M1 400	400

Wiring diagram

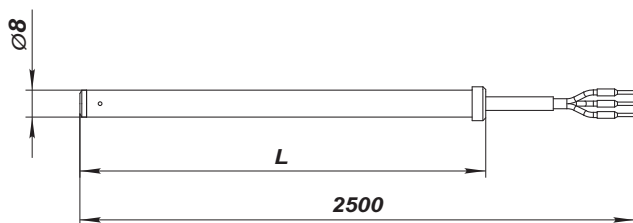
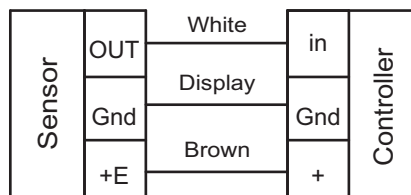

KDT2-M1 duct temperature sensor

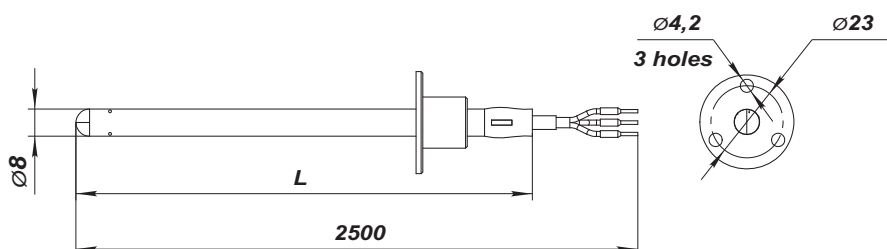

KDT2-M duct temperature sensor

Duct temperature sensors with a terminal box **KDT-MK**



■ Application

The duct temperature sensors are designed for installation in the air duct and temperature measurement of the air flow in the ventilation and air conditioning systems.

■ Design

The sensing element, NTC thermometer resistor, is enclosed in the aluminium sleeve. The thermometer resistor electric resistor depends on the temperature, the non-linear resistance. Connection of the sensor to the controller is double-wired, regardless of polarity.

The KDT-MK sensor delivery set includes a mounting flange with a fixing screw for its fixation to the air duct wall.

The sensors are supplied with a 2.5 m connecting cable. The immersion depth is adjusted for 100, 150, 200 or 400 mm.

■ Mounting

Fixation with screws to the air duct wall by means of the flange with the sensing element located the air stream.

Technical data:

	KDT-MK
Temperature measuring range [°C]	-30...+60
Voltage [V]	≤ 5 DC *
Output	resistance
Electric connection	double-wire, cross section 2x0.25 mm ²
Relative humidity	up to 90%, no condensation
Protection rating	IP 54
Electrical appliance class	III

*Maximum current generated through the sensor by the applied voltage is 2 mA.

Overall dimensions:

Type	L [mm]
KDT-MK 100	100
KDT-MK 150	150
KDT-MK 200	200
KDT-MK 400	400

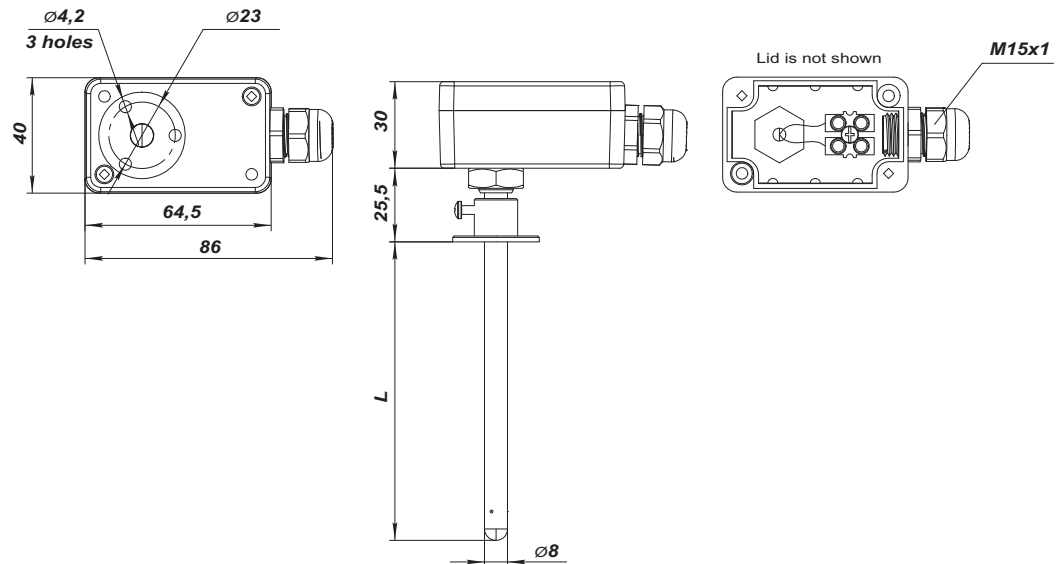

Duct temperature sensors with a terminal box
KDT2-MK



■ **Application**

The duct temperature sensors are designed for installation in the air duct and temperature measurement of the air flow in the ventilation and air conditioning systems.

■ **Design**

The sensor consists of the integrated circuit chip located inside the plastic casing. This sensor type has a linear transfer characteristics of output voltage to temperature and a three-wire connection to power mains.

This sensor type is not compatible with resistance

sensors. During electric connections the polarity of the outputs connected to the inputs of the air handling units must be considered.

The KDT2-MK sensor delivery set includes a mounting flange with a fixing screw for its fixation to the air duct wall. The sensors are supplied with a 2.5 m connecting cable. The immersion depth is adjusted for 100, 150, 200 or 400 mm.

■ **Mounting**

Fixation with screws to the air duct wall by means of the flange with the sensing element located the air stream.

Technical data:

	KDT2-MK
Temperature measuring range [°C]	-30...+60
Voltage [V]	2,7...10
Output resistance [Ohm]	800
Electric connection	three-wire, cross section 3x0.25 mm ²
Relative humidity	up to 90%, no condensation
Protection rating	IP 54
Electrical appliance class	III

Overall dimensions:

Type	L [mm]
KDT2-MK 100	100
KDT2-MK 150	150
KDT2-MK 200	200
KDT2-MK 400	400

Wiring diagram

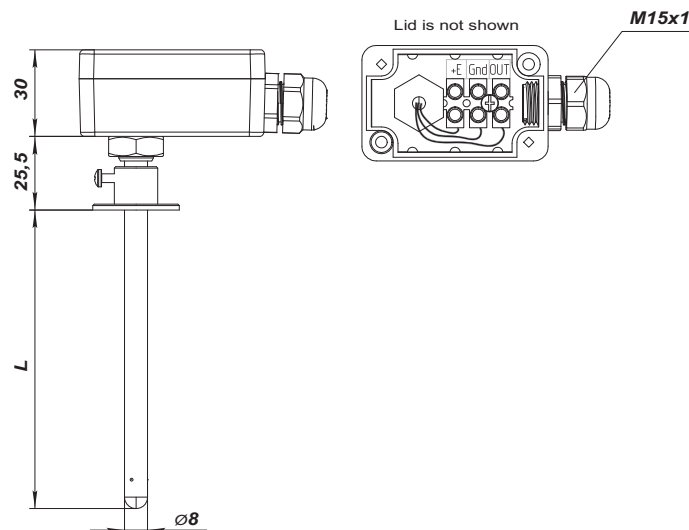
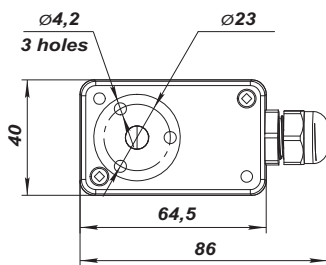
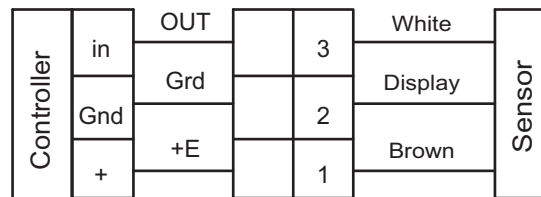

Outdoor temperature sensor NDT



■ Application

The outdoor temperature sensor is designed for outdoor temperature measurement in ventilation and air conditioning systems.

■ Design

The sensing element, NTC thermometer resistor, is enclosed in the plastic housing. The plastic housing incorporates also a copper probe for higher sensing efficiency. The thermometer resistor electric resistor

depends on the temperature, the non-linear resistance. Connection of the sensor to the controller is double-wired, regardless of polarity.

The sensor is connected to power mains through the terminal blocks of the circuit board located in the casing.

■ Mounting

Outdoor mounting.

Technical data:

	NDT
Temperature measuring range [°C]	-30...+60
Voltage [V]	≤ 5 DC *
Output	resistance
Electric connection	cross section 2x0.25 mm ²
Relative humidity	up to 90%, no condensation
Protection rating	IP 54
Electrical appliance class	III

*Maximum current generated through the sensor by the applied voltage is 2 mA.

Overall dimensions [mm]

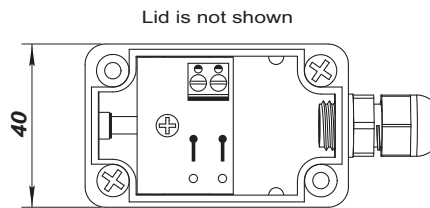
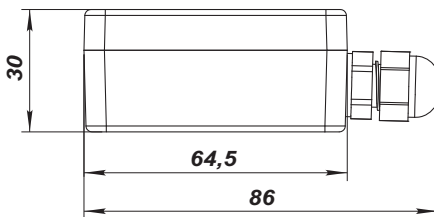

Outdoor temperature sensor
NDT2



■ **Application**

The outdoor temperature sensor is designed for outdoor temperature measurement in ventilation and air conditioning systems.

■ **Design**

The sensor consists of the integrated circuit chip located inside the plastic casing. This sensor type has a linear transfer characteristics of output voltage to

temperature and a three-wire connection to power mains.

This sensor type is not compatible with resistance sensors. During electric connections the polarity of the outputs connected to the inputs of the air handling units must be considered.

■ **Mounting**

Outdoor mounting.

Technical data:

	NDT2
Temperature measuring range [°C]	-40 ...+60
Voltage [V]	4... 10
Output resistance [Ohm]	800
Electric connection	cross section 3x0.25 mm ²
Relative humidity	up to 90%, no condensation
Protection rating	IP 54
Electrical appliance class	III

Overall dimensions [mm]

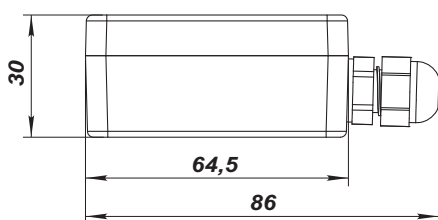

Lid is not shown

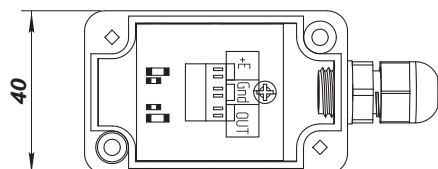

Wiring diagram

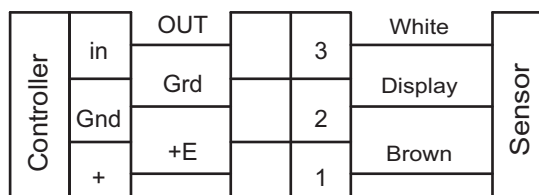

Duct temperature sensors TG-K



■ Application

The duct sensors are used jointly with PULSER-M temperature controllers.

■ Design and control

The sensor is installed in the air duct. The sensors are supplied with connecting cable 1.5 m long and have adjustable length. The sensors differ in temperature sensitivity range.

■ Mounting

The sensor is installed in the air stream area. It is connected to the wall through a flange with two $\varnothing 5$ mm openings located at 40 mm center-to-center distance.

Technical data:

	TG-K
Insertion length [mm]	15...145 (adjustable)
Length cable [m]	1.5
Sensitive element	linearized NTC sensor
Accuracy	above + /-1 °C
Pressure range [Pa]	50...500
Protection rating	IP 54

Duct sensor model range:

Model	Temperature range
TG-K300	-30...+30 °C
TG-K330	0...30 °C
TG-K350	20...50 °C
TG-K360	0...60 °C

Overall dimensions [mm]

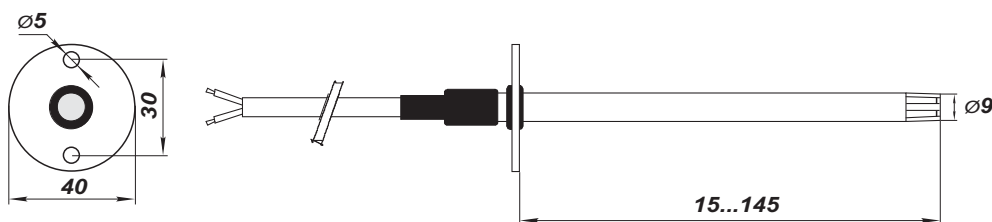

CO₂ sensor
CO2-1

CO₂ sensor
CO2-2



■ **Application**

The sensor is designed for indoor carbon dioxide concentration measurement and respective air capacity regulation through the control output signal to the fan. Air capacity control based on CO₂ concentration is an efficient energy saving solution.

■ **Design and compatability**

The sensor has two separate ports. Relay normally opened dry contact and analogue output 0...10 V (this output is adjustable for 2...10 V/0...20 mA/4...20 mA). The relay output is designed to switch the ventilation system on/off depending on CO₂ concentration and the analogue output enables smooth fan speed control. Smooth fan speed control by CO₂ sensor is possible only for the units equipped with EC motors or with an external fan speed controller with 0...10 V input, refer RS...TA or VFED. At smooth fan speed control the fan speed changes proportionally to carbon dioxide emissions. The relay and analogue outputs make the sensor compatible with any ventilation system. The integrated self-calibration system ensures reliable sensor operation during the sensor service life.

■ **Modifications**

The sensor is available in two modifications – CO2-1 and CO2-2. The CO2-1 model incorporates LED lights for CO₂ concentration and operation buttons for three operation modes: 1 – on, 2 – off, 3 – operation by

CO₂ concentration. The button is used to switch the ventilation system on or off when CO₂-based operation is not required. The CO2-2 model has no LED-lights and on/off button. The model is applied for premises requiring permanent ventilation, i.e. at schools.

■ **Mounting and power supply**

The sensor is for wall surface mounting. Power supply from low-current 24 V AC. If power supply 24 V is not available, connect the TRF plug that is offered as an accessory.

■ **Accessories**

Power supply unit is applied for connection of the sensor to 220 V (model **TRF-220/24-1,6**) or 120 V (**TRF-120/24-1,6**) AC power mains.



Technical data:

Power supply / consumption	24 VAC (50/60 Hz ± 10%), 24 VDC/1.6 W Max
Gas detection analyzer	nondispersive infrared analyzer (NDIR) with self-calibrating system
CO ₂ detection range	0~2000 ppm (parts per million)
Accuracy at 25 °C (77 °F), 2000 ppm	± 40 ppm +3% reading
Response time	<2 minutes when 90% fluctuation
Warm-up time at start-up	<5 min. (in action), 48 hours (first time)
Analogue output	0~10VDC (factory setting), 2~10VDC, 0~20mA, 4~20mA
Output on/off	<240VAC/30VDC 3A switching current (load resistance)
6 LED lights – CO ₂ indicators (for model CO2-1)	1st green light indicator when CO ₂ concentration ≤ 600ppm 1st and 2nd green light indicators when 600 ppm < CO ₂ concentration ≤ 800 ppm 1st yellow light indicator when 800 ppm < CO ₂ concentration ≤ 1200 ppm 1st and 2nd yellow light indicators when 1200 ppm < CO ₂ concentration ≤ 1400 ppm 1st red light indicator when 1400 ppm < CO ₂ concentration ≤ 1600 ppm 1st and 2nd red light indicators when CO ₂ concentration > 1600 ppm
Operating conditions / storage recommendations	0~50 °C (32~122 °F); 0~95% relative humidity without condensation -40~70 °C (-40~158 °F); 0~95% relative humidity without condensation
Weight / Dimensions	0.120 kg./100 mm x 80 mm x 30 mm

Sensor connection diagram

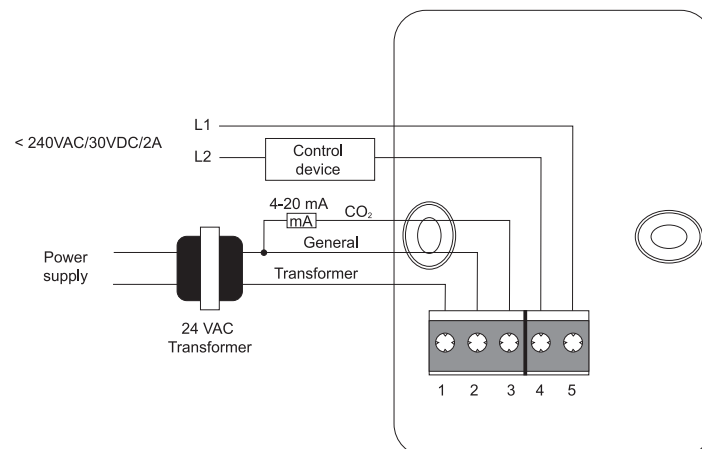

Series
BELIMO
CM230/CM24



■ **Application**

The SM series actuators with actuating torque 2 Nm are designed for controlling air dampers with cross section up to 0.4 m² installed in various ventilation and air conditioning systems.

■ **Design**

The actuator is installed directly on the damper axis and locked with a special spindle clamp to prevent its turning-through. The actuator overload protection

stops the actuator once it reaches the end positions. In case of installation of a magnet on the actuator housing the gear is disengaged and the damper changes into manual operation mode. The turning angle is adjusted by mechanical end stops.

■ **Control**

The **CM24A**, **CM230** models are controlled by the three-point control system. The damper is opened or closed by the single-circuit control.

Technical data:

	CM24	CM230
Voltage	24 AC 50/60 Hz, 24 DC	230 AC 50/60 Hz
Nominal voltage range [V]	19.2...28.8 AC 19.2...28.8 DC	85...265 AC
Rated power [VA]	1	2
Power consumption in operation / at rest [W]	0.5 / 0.5	1 / 1
Connecting cable	1 m long, 3 x 0.75 mm ²	
Positioning accuracy	± 5%	
Rotation direction	determined by terminal connection	
Torque [Nm]	2, nominal voltage	
Rotation angle:		
– no end stop	endless	
– with end stop	fixed 315° / adjustable 0...287.5° with 2.5° increment	
Running time	75 s / 90°	
Position indicator	mechanical	
Ingress protection	IP 54 at any mounting position	
Electrical protection class	III low voltage II totally insulated	
Operation temperature [°C]	-30...+50	
Storage temperature [°C]	-40...+80	
Ambient humidity	95%, no condensation	
Noise level [dBA]	35	
Maintenance	not required	
Weight [kg]	0.13	

Wiring diagram

Single-wire control

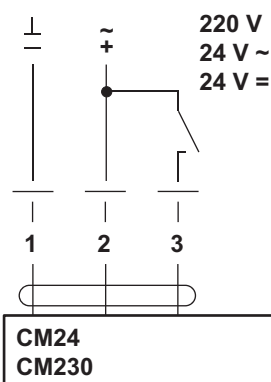

Two-wire control

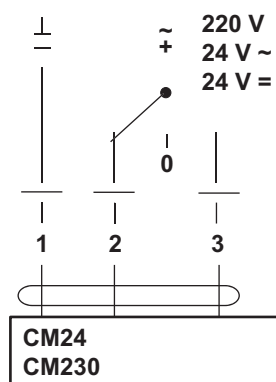

Overall dimensions [mm]

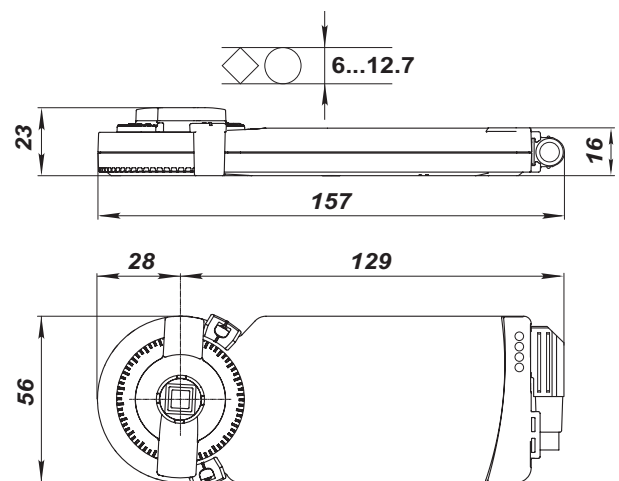

Series
BELIMO
LM230A/LM24A



■ Application

The SM series actuators with actuating torque 5 Nm are designed for controlling air dampers with cross section up to 1 m² installed in various ventilation and air conditioning systems.

■ Design

The actuator is installed directly on the damper axis and locked with a special spindle clamp to prevent its turning-through. The actuator overload protection

stops the actuator once it reaches the end positions. In case of pressing the button on the actuator housing the gear is disengaged and the damper changes into manual operation mode. The turning angle is adjusted by mechanical end stops.

■ Control

The **LM24A**, **LM230A** models are controlled by the three-point control system. The damper is opened or closed by the single-circuit control.

Technical data:

	LM24A	LM230A
Voltage	24 AC 50/60 Hz, 24 DC	230 AC 50/60 Hz
Nominal voltage range [V]	19.2...28.8 AC 19.2...28.8 DC	85...265 AC
Rated power [VA]	2	4
Power consumption [W]	1	1.5
Feedback potentiometer	integrated 5 kOhm ± 5%	
Connecting cable	1 m long, 3 x 0.75 mm ²	
Rotation direction	selected by 0/1 switch positioning	
Mechanical control	self-resetting button	
Torque [Nm]	5 (at nominal voltage)	
Rotation angle:	max. 95°, adjustable with mechanical end stops	
Running time	150 s	
Position indicator	mechanical	
Ingress protection	IP 54 at any mounting position	
Electrical protection class	III low voltage II totally insulated	
Operation temperature [°C]	-30...+50	
Storage temperature [°C]	-40...+80	
Ambient humidity	95%, no condensation	
Noise level [dBA]	35	
Maintenance	not required	
Weight [kg]	0.6	

Wiring diagram

Single-wire control

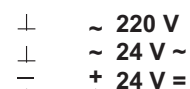

LM230A
LM24A

Two-wire control

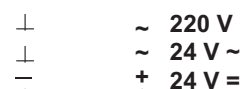

Several wires may be parallel connected with respect to the power

LM230A
LM24A

Overall dimensions [mm]

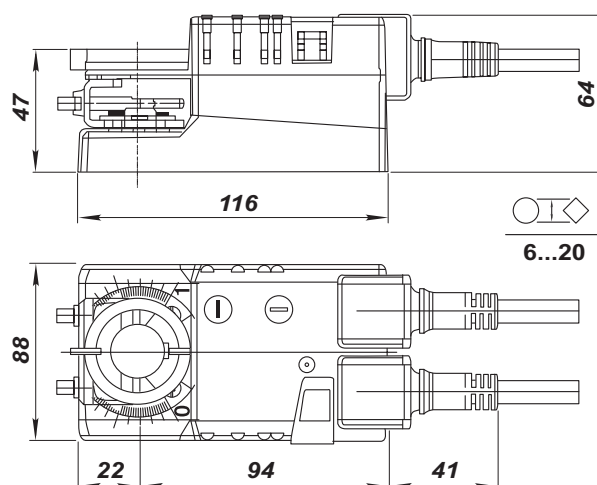

Series
BELIMO
TF230/TF24



■ **Application**

The TF series actuators with actuating torque 2 Nm are designed for controlling air dampers with cross section up to 0.4 m² installed in various ventilation and air conditioning systems and performing protection functions, as freezing protection, smoke detection, etc.

■ **Design**

The actuator moves the damper to its operating position while tensioning the return spring at the same time. In case of power supply cut-off, the damper moves back to its safe position by the spring energy. The actuator is installed directly on the damper axis and locked with a special spindle clamp to prevent its turning-through. The actuator overload protection stops the actuator once it reaches the end positions. The turning angle may be adjusted by a mechanical end stop.

Technical data:

	TF24	TF230
Voltage	24 AC 50/60 Hz, 24 DC	230 V ~ 50/60 Hz
Nominal voltage range [V]	19.2...28.8 AC 21.6...28.8 DC	85...265 AC
Rated power [VA]	4 (max. I 5.8 A at t = 5 ms)	4 (max. I 150 mA at t = 10 ms)
Power consumption in operation / at rest [W]	2 / 1.3	2/ 1.3
Connecting cable	1 m long, 2 x 0.75 mm ²	
Rotation direction	determined by L/R positioning	
Torque (motor / spring) [Nm]	2, nominal voltage / 2	
Rotation angle:	max. 95°, adjustable 37...100% with a mechanical end stop	
Running time (motor / spring) [s]	40...75 (0...2 Nm) / < 25 at -20...50 °C	
Service life	60 000 switching operations	
Ingress protection	IP 42	
Electrical protection class	III low voltage II totally insulated	
Operation temperature [°C]	-30...+50	
Storage temperature [°C]	-40...+80	
Ambient humidity	95%, no condensation	
Noise level (motor/ spring) [dBA]	50 / ~ 62	
Maintenance	not required	
Weight [kg]	0.6	

Wiring diagram

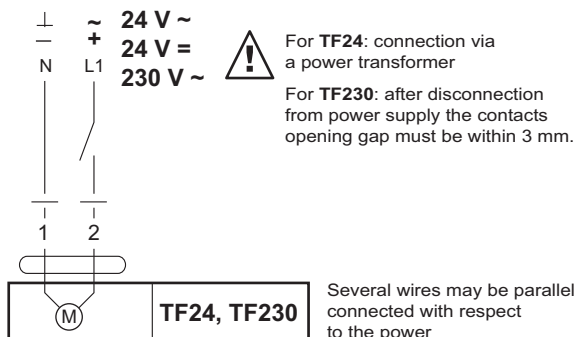

Overall dimensions [mm]

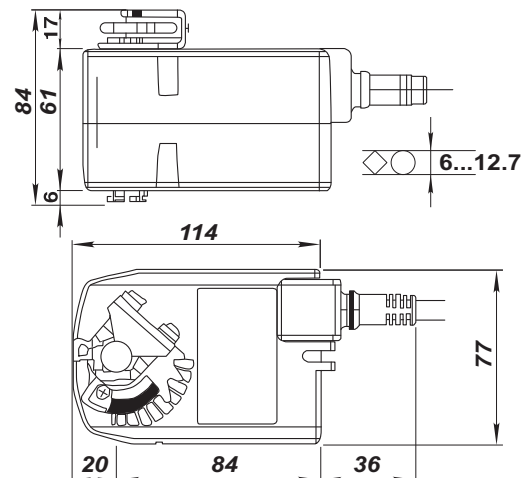

Series
BELIMO
LF230/LF24



■ **Application**

The LF series actuators with actuating torque 4 Nm are designed for controlling air dampers with cross section up to 0.8 m² installed in various ventilation and air conditioning systems and performing protection functions, as freezing protection, smoke detection, etc.

■ **Design**

The actuator moves the damper to its operating position while tensioning the return spring at the same time. In case of power supply cut-off, the damper moves back to its safe position by the spring energy. The actuator is installed directly on the damper axis and locked with a special spindle clamp to prevent its turning-through. The actuator overload protection stops the actuator once it reaches the end positions. The turning angle may be adjusted by a mechanical end stop.

Technical data:

	LF24	LF230
Voltage	24 AC 50/60 Hz, 24 DC	230 AC 50/60 Hz
Nominal voltage range [V]	19.2...28.8 AC 21.6...28.8 DC	198...264 AC
Rated power [VA]	7 (max. I 5.8 A at t = 5 ms)	7 (max. I 150 mA at t = 10 ms)
Power consumption in operation / at rest [W]	5 / 2.5	5 / 3
Connecting cable	1 m long, 2 x 0.75 mm ²	
Rotation direction	determined by L/R positioning	
Torque (motor / spring) [Nm]	4 (at nominal voltage) / 4	
Rotation angle:	max. 95°, adjustable 37...100% with a mechanical end stop	
Running time (motor / spring) [s]	40...75 (0...4 Nm) / ~ 20 at -20...50 °C	
Service life	60 000 switching operations	
Ingress protection	IP 54 (installation with cable downwards)	
Electrical protection class	III low voltage II totally insulated	
Operation temperature [°C]	-30...+50	
Storage temperature [°C]	-40...+80	
Ambient humidity	95%, no condensation	
Noise level (motor/ spring) [dBA]	50 / ~ 62	
Maintenance	not required	
Weight [kg]	1.4	1.55

Wiring diagram

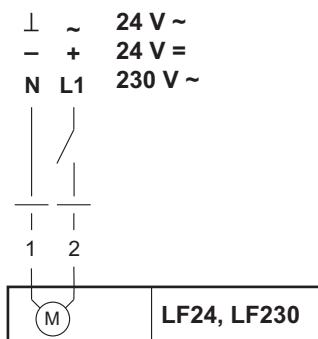

Warning!

For **LF24**: connection via a power transformer

For **LF230**: after disconnection from power supply the contacts opening gap must be within 3 mm.

Several wires may be parallel connected with respect to the power

Overall dimensions [mm]

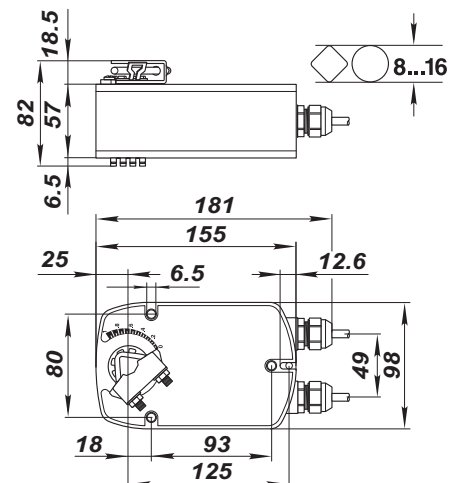

Automation on the basis of SL-Aqua and SL-Electric control boards



Description

The basic control board is designed on the basis of SYNERGY VS-01 controller with a configuration optimized for control and protection of the ventilation equipment. The control and the power sections are integrated in one plastic casing (IP65). The standard delivery set of the control board includes a control panel with an LCD display and necessary temperature sensors. The control board is designed for indoor application with the ambient temperature ranging from +5°C up to +40°C and relative humidity up to 80% in dry environments free of dust and aggressive chemicals.

Purpose

- ▶ Air flow and temperature control of the supply air.
- ▶ Maintaining of set indoor air temperature.
- ▶ Emergency prevention, timely warning alarms.

Applications

The control boards are designed for controlling ventilation system in residential buildings, cottages, offices, sports and shopping centres, restaurants, cafés, administrative buildings, industrial premises and warehouses.

Control boards' functions



System ON/OFF



Air flow rate setting

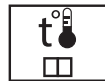

Temperature setting



Date/time setting



Daily timer



Weekly timer



Filter clogging hour meter



Indicator backlight ON/OFF



Alarm signal ON/OFF

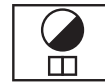

Indicator brightness adjustment



Settings

Designation key

Series	Three-phase electric heater power (only for SL-Electric) [kW]	Maximum power of the fan motor [kW]	Frequency controller
SL-Aqua - for water heaters; SL-Electric - for electric heaters;	10; 16; 25	0.55; 2.0; 4.0; 5.5; 11.0	- no; f - yes.

Control board name	Heat exchanger	Heater	Max. motor power	Note
SL-Aqua-0.55	no/cross-flow	water	1 phase, AC/DC, up to 0.55 kW	relay
SL-Aqua-2.0	no/cross-flow	water	1-3 phases, AC/DC, up to 2.0 kW	contactor and circuit breaker for motors
SL-Aqua-4.0	no/cross-flow	water	1-3 phases, AC/DC, up to 4.0 kW	contactor for 4 kW motor, 25 A circuit breaker
SL-Aqua-11.0	no/cross-flow	water	3 phases, AC/DC, up to 11.0 kW	contactor for 11 kW motor, 40 A circuit breaker
SL-Aqua-5.5f	no/cross-flow	water	3 phases, AC, up to 5.5 kW for connection to a frequency converter	25 A circuit breaker, enabling signal
SL-Aqua-11.0f	no/cross-flow	water	3 phases, AC, up to 11.0 kW for connection to a frequency converter	50 A circuit breaker, enabling signal
SL-Electric-10.0-0.55	no/cross-flow	electric, 3 phases, up to 10 kW	1 phase, AC/DC, up to 0.55 kW	relay
SL-Electric-16.0-2.0	no/cross-flow	electric, 3 phases, up to 16 kW	1-3 phases, AC/DC, up to 2.0 kW	contactor and circuit breaker for motors
SL-Electric-25.0-4.0	no/cross-flow	electric, 3 phases, up to 25 kW	1-3 phases, AC/DC, up to 4.0 kW	contactor for 4 kW motor, 25 A circuit breaker
SL-Electric-25.0-11.0	no/cross-flow	electric, 3 phases, up to 25 kW	3 phases, AC/DC, up to 11.0 kW	contactor for 11 kW motor, 40 A circuit breaker
SL-Electric-25.0-5.5f	no/cross-flow	electric, 3 phases, up to 25 kW	3 phases, AC, up to 5.5 kW for connection to a frequency converter	25 A circuit breaker, enabling signal
SL-Electric-25.0-11.0f	no/cross-flow	electric, 3 phases, up to 25 kW	3 phases, AC, up to 11.0 kW for connection to a frequency converter	50 A circuit breaker, enabling signal

SL-Aqua control boards of supply/supply and extract ventilation systems with the water heater

Designed for operating as a part of automation system of supply and air handling units with a water heater.

Applications

Control boards are designed for a complex control and protection of ventilation and air conditioning systems. Used in conjunction with air handling units equipped with a water heater, a cross-flow heat exchanger and a DX-cooler.

The control board casing contains the control and protective components of the power section and the automation electronic circuitry. The control board is designed for indoor application in dry environments free of dust and aggressive chemicals.

The control board has the following functions:

- ▶ Switching the electric motors of the unit ON/OFF.
- ▶ Stepless fan speed control (use of an additional external control device is required).
- ▶ Controlling the fan operation.

- ▶ Maintaining the set supply air temperature by means of controlling the 3-way heat medium control valve
- ▶ Water heater freeze protection on the feedback from the freeze thermostat installed downstream of the heater and the return heat medium temperature sensor.
- ▶ Controlling the external circulation pump installed in the line supplying heat medium to the water heater.
- ▶ Controlling the heat exchanger bypass damper.
- ▶ Freeze protection of the heat exchanger.
- ▶ Controlling the compressor and condensing unit (CCU) of the air cooler.
- ▶ Supply and extract filters clogging control according to hour meter readings.
- ▶ Controlling the electric actuator of the supply and exhaust air dampers.

- ▶ Automatic control of the ventilation equipment operation using the weekly timer.
- ▶ System shutdown on a signal from fire fighting system.
- ▶ The control board is designed for indoor application with the ambient temperature ranging from +5°C up to +40°C and relative humidity up to 80%.

Mounting

The control board is designed for vertical mounting on the wall. Run the cables using cable passages or in the wall. The spring-loaded return air damper actuators may be connected to the control units. The actuators are available with either 24 V DC or 230 V AC power supply.

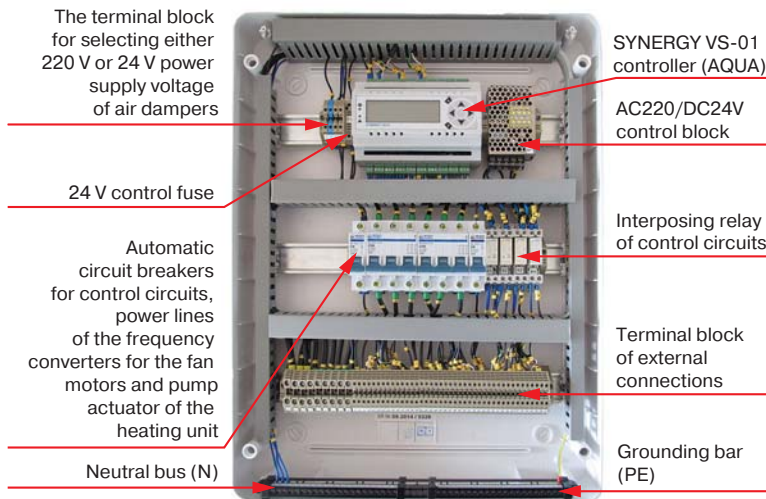

Overall dimensions [mm]

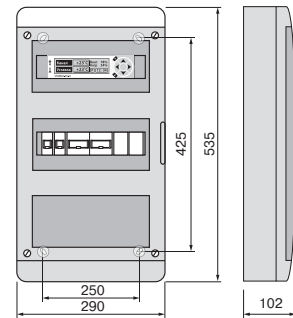

SL-Aqua-0.55; SL-Aqua-2.0

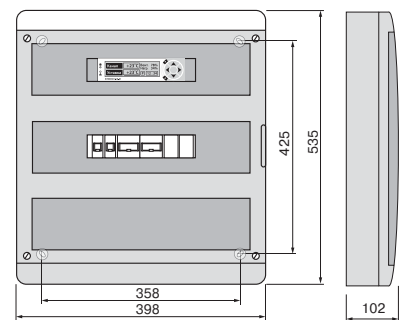

SL-Aqua-4.0; SL-Aqua-5.5f; SL-Aqua 11.0

Accessories



page 110



page 108



page 95



page 94



page 60



page 91



page 96



SINUS M, FC51 frequency converter

Designation key on the SL-Aqua functional diagrams



Designation	Name	Type
D1	Supply air damper	to be ordered separately
D2	Exhaust air damper	to be ordered separately
F1	Supply filter	pocket type
F2	Extract filter	pocket type
K1	DX-cooler	
M1	Supply fan	to be ordered separately
M2	Extract fan	to be ordered separately
ATV1	Frequency converter of the supply fan	to be ordered separately
ATV2	Frequency converter of the extract fan	to be ordered separately
PD3	Differential pressure switch of the supply fan	NO
PD4	Differential pressure switch of the extract fan	NO
Q1	Electric heater	max. 25 kW
RK1	Cross-flow heat exchanger	
SM1	Supply air damper electric actuator	LM 230 / LM24
SM2	Exhaust air damper electric actuator	LM 230 / LM24
SM4	Bypass damper electric actuator	LM24A
TE1	Outdoor air temperature sensor	NTC
TE2	Temperature sensor downstream of the heat exchanger	NTC
TE5	Duct temperature sensor	NTC
TK50	Thermal contact of the heater	NC
TK90	Response temperature = +50°C	NC
P1	Thermal contact of the heater	Synergy SP-01
	Response temperature = +90°C	
	Control panel	

SL-Aqua functional diagrams

Direct-flow unit (AC/EC motor) with a water heater

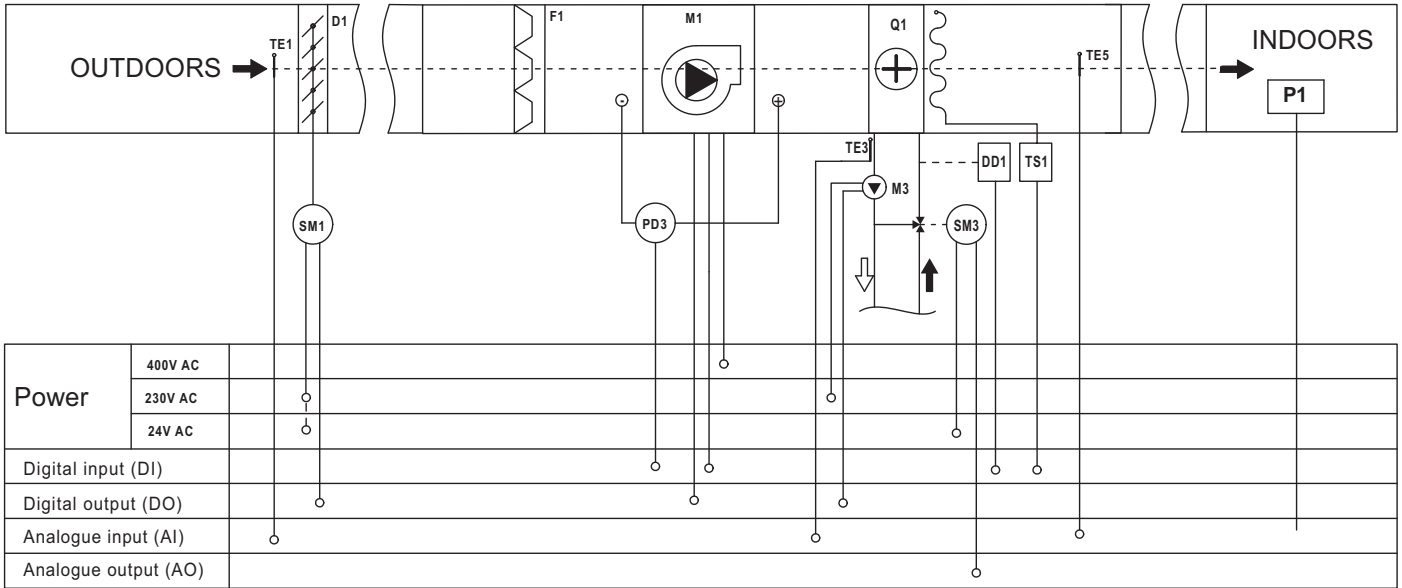

Direct-flow unit (AC motor with a frequency converter/EC motor) with a water heater

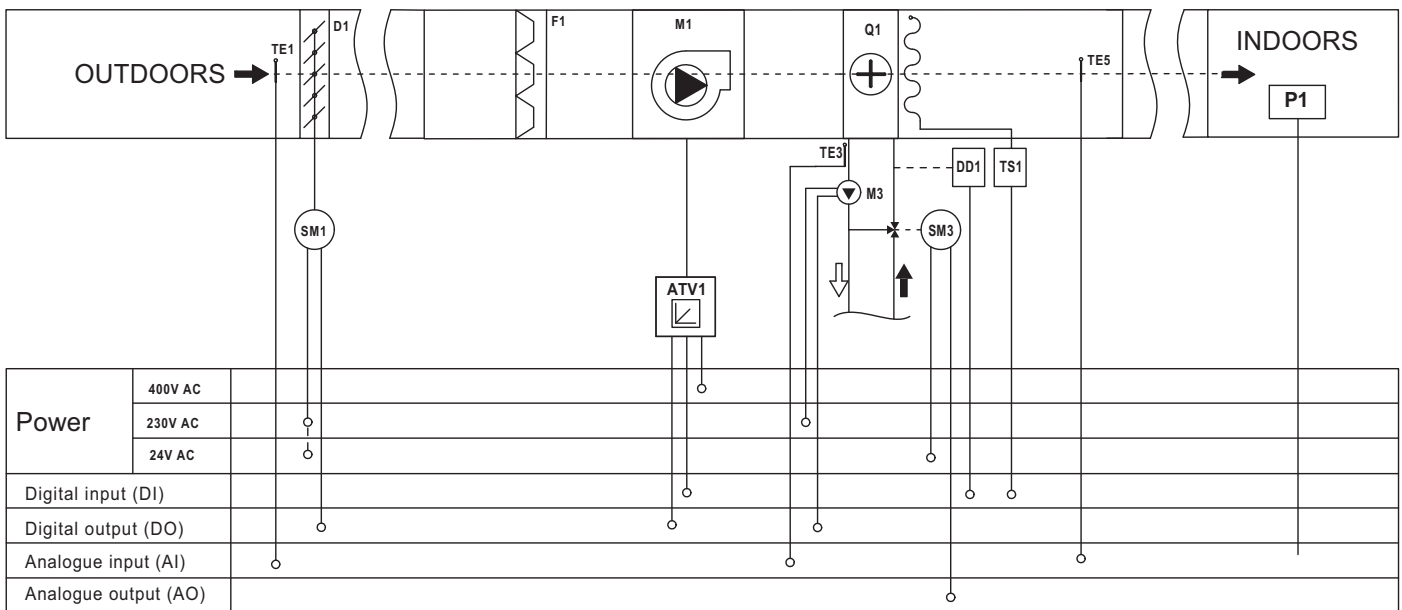

Direct-flow unit (AC/EC motor) with a water heater and a DX-cooler

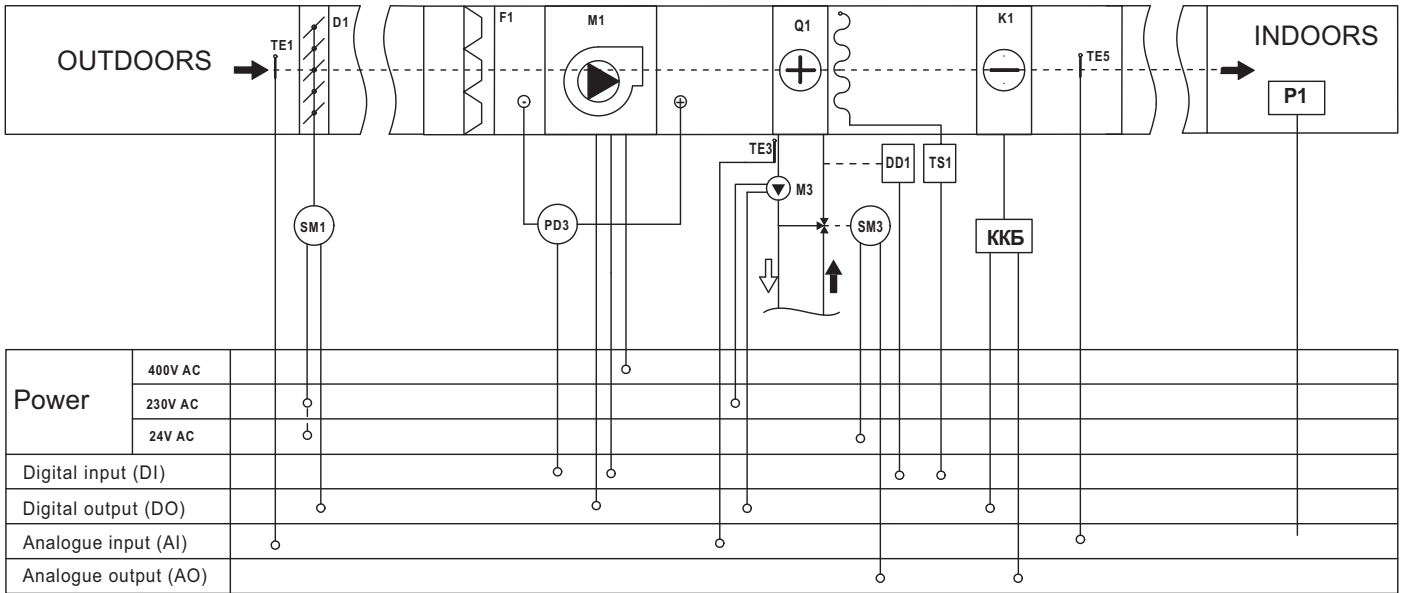

Direct-flow unit (AC motor with a frequency converter/EC motor) with a water heater and a DX-cooler

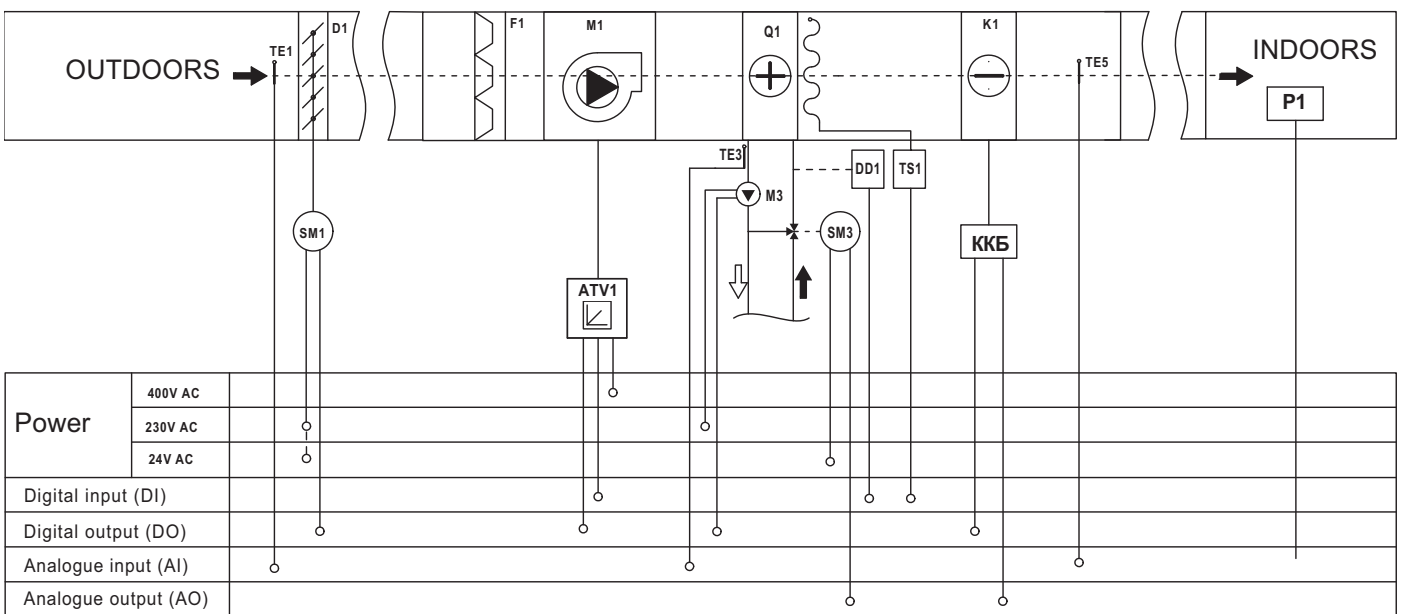

Air handling unit (AC/EC motor) with a water heater

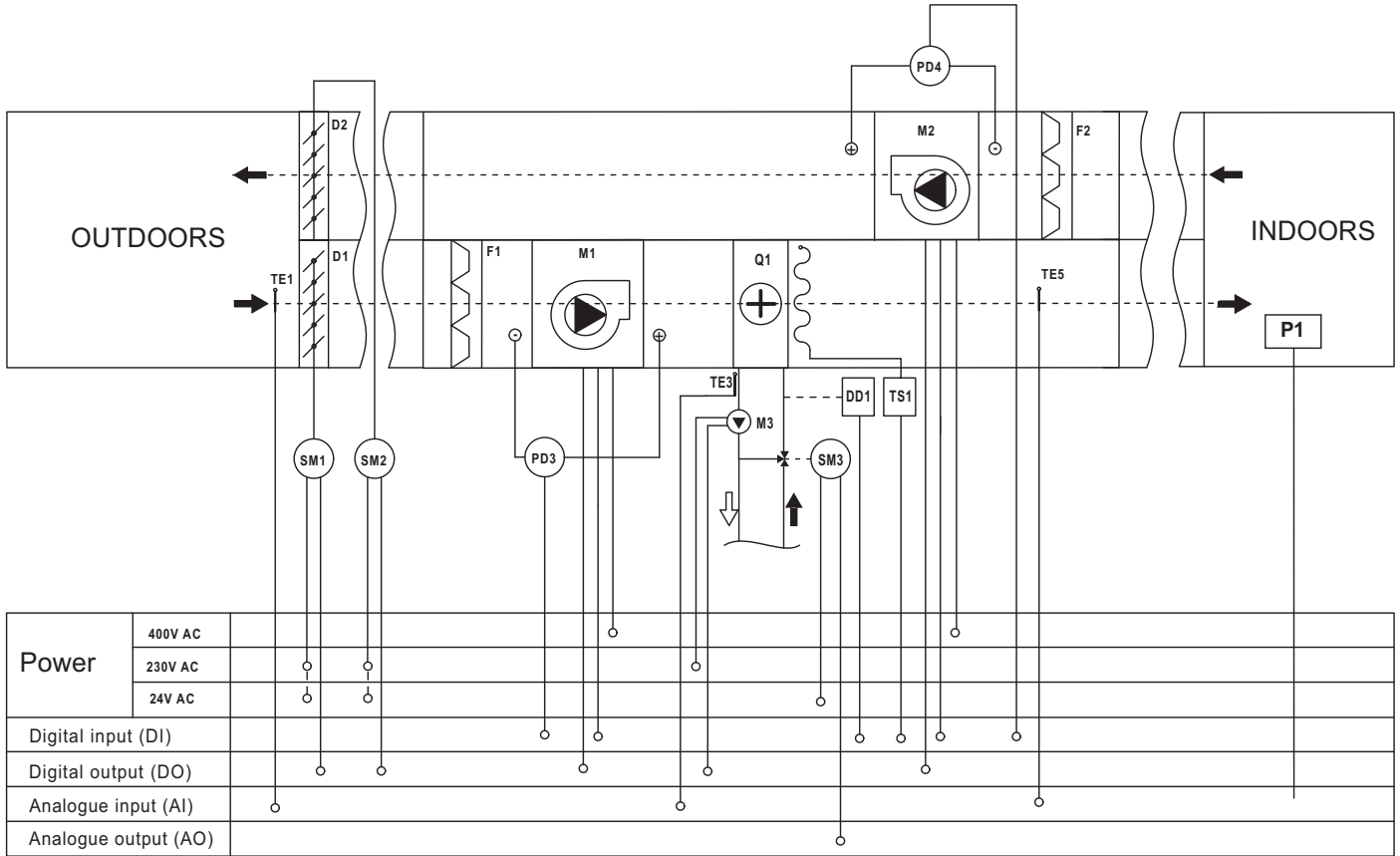

Air handling unit (AC motor with a frequency converter/EC motor) with a water heater

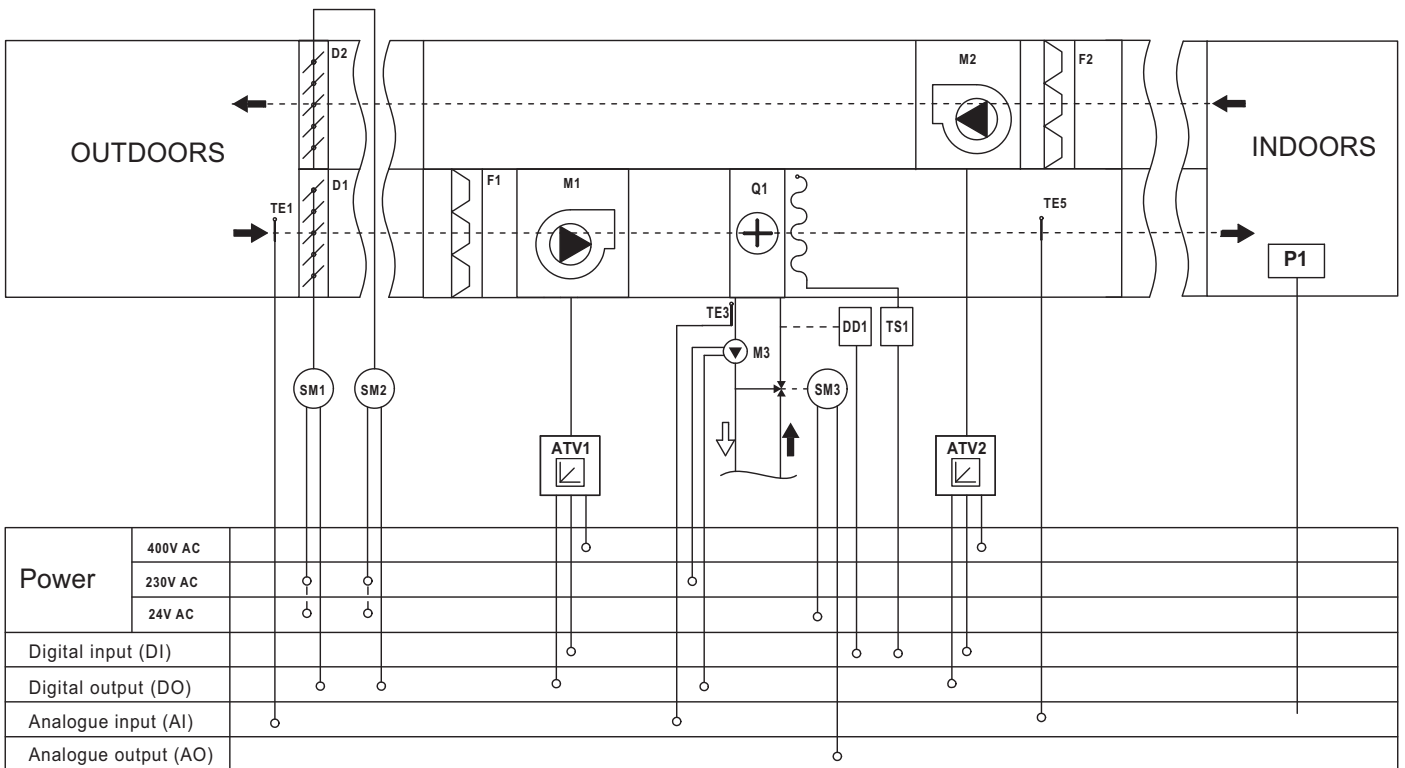

Air handling unit (AC/EC motor) with a water heater and a DX-cooler

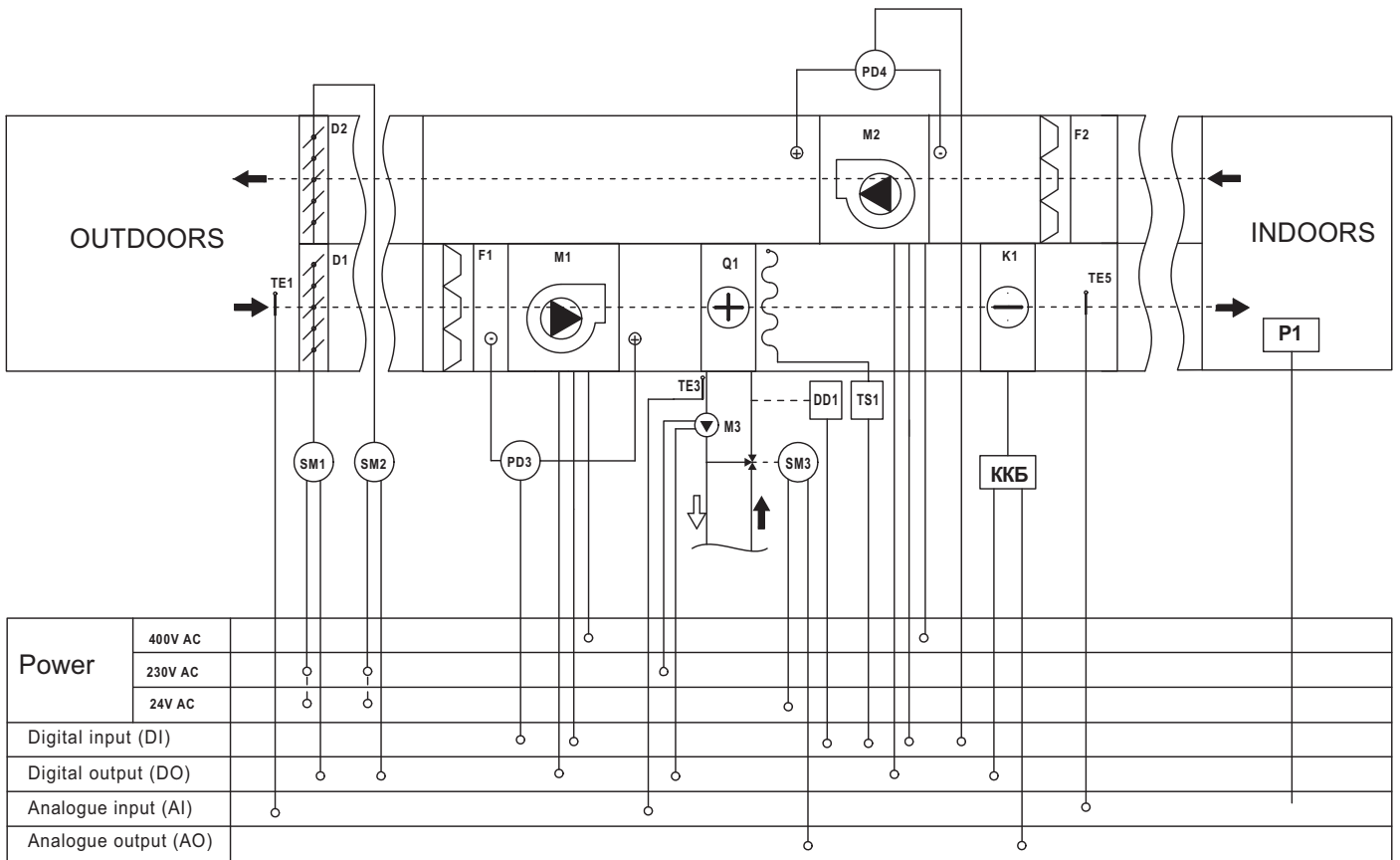

Air handling unit (AC motor with a frequency converter/EC motor) with a water heater and a DX-cooler

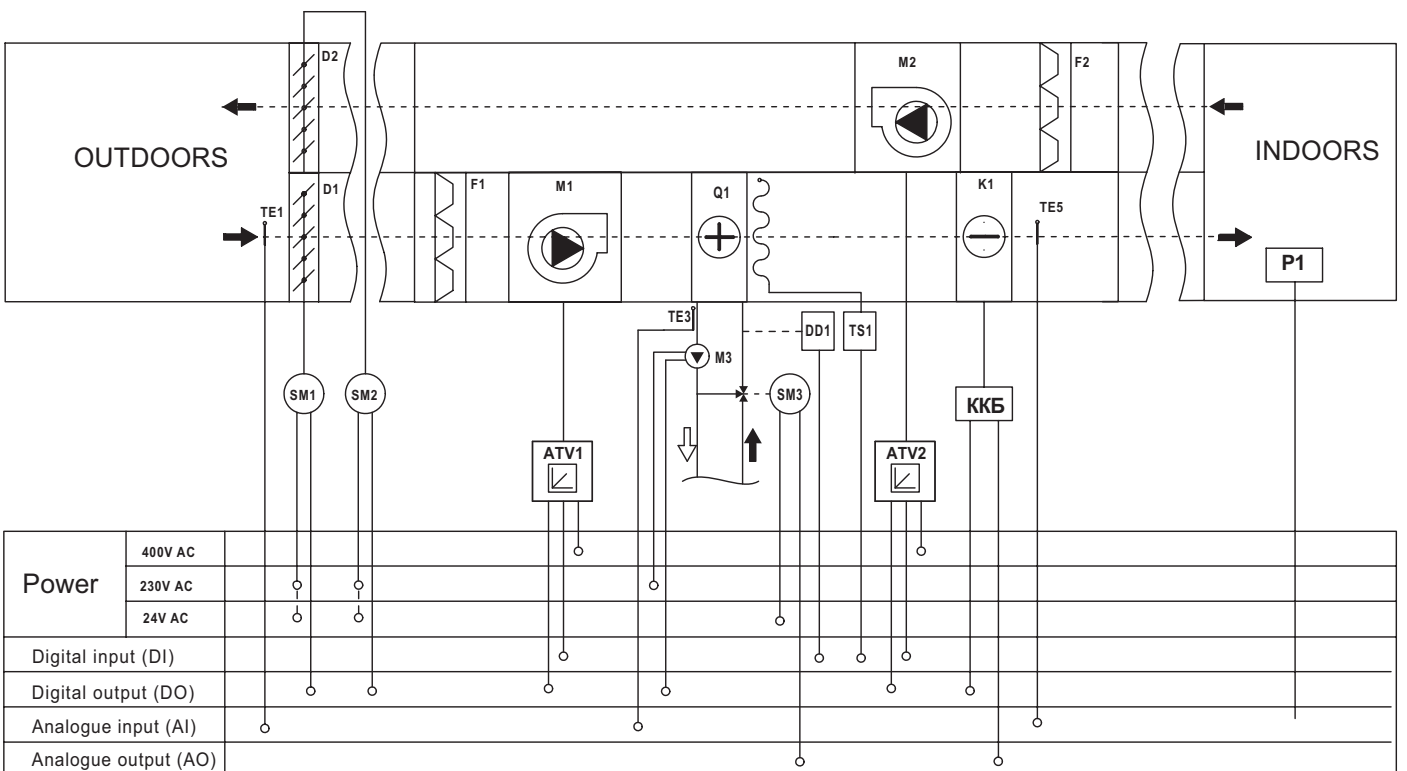

Air handling unit (AC/EC motor) with a water heater, a DX-cooler and a cross-flow heat exchanger

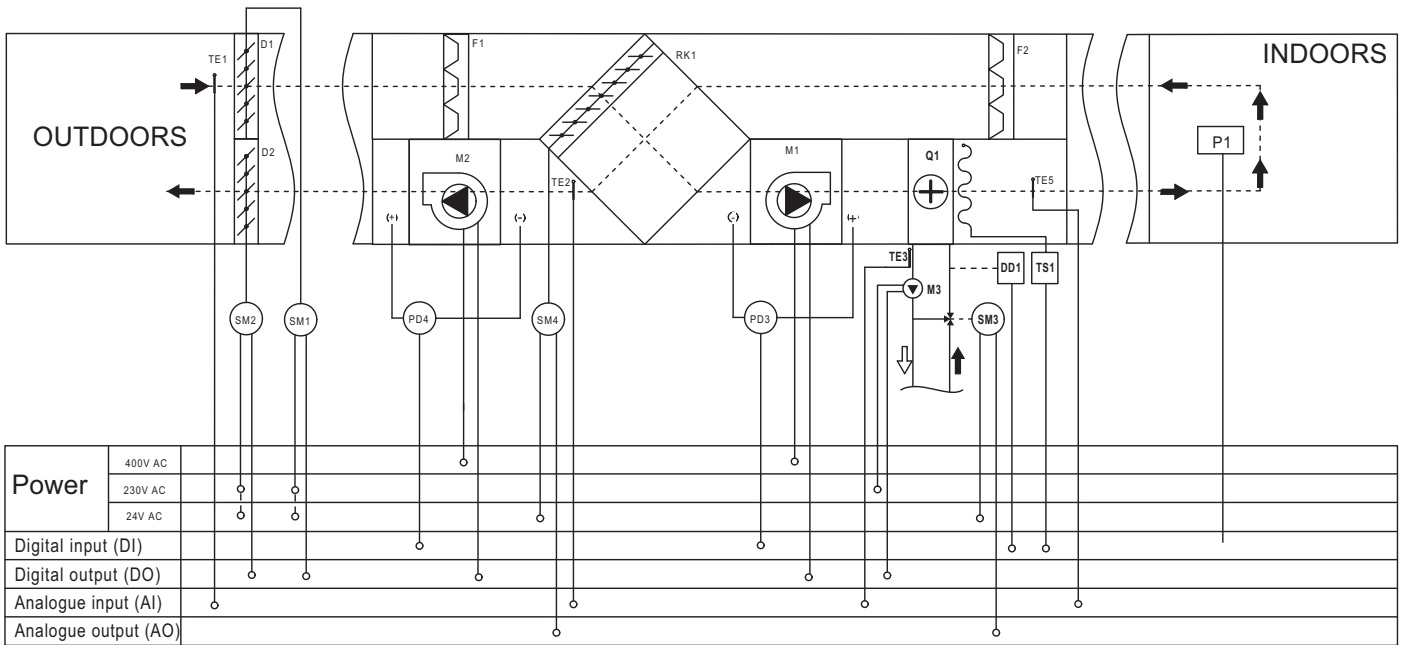

Air handling unit (AC motor with a frequency converter/EC motor) with a water heater, a DX-cooler and a cross-flow heat exchanger

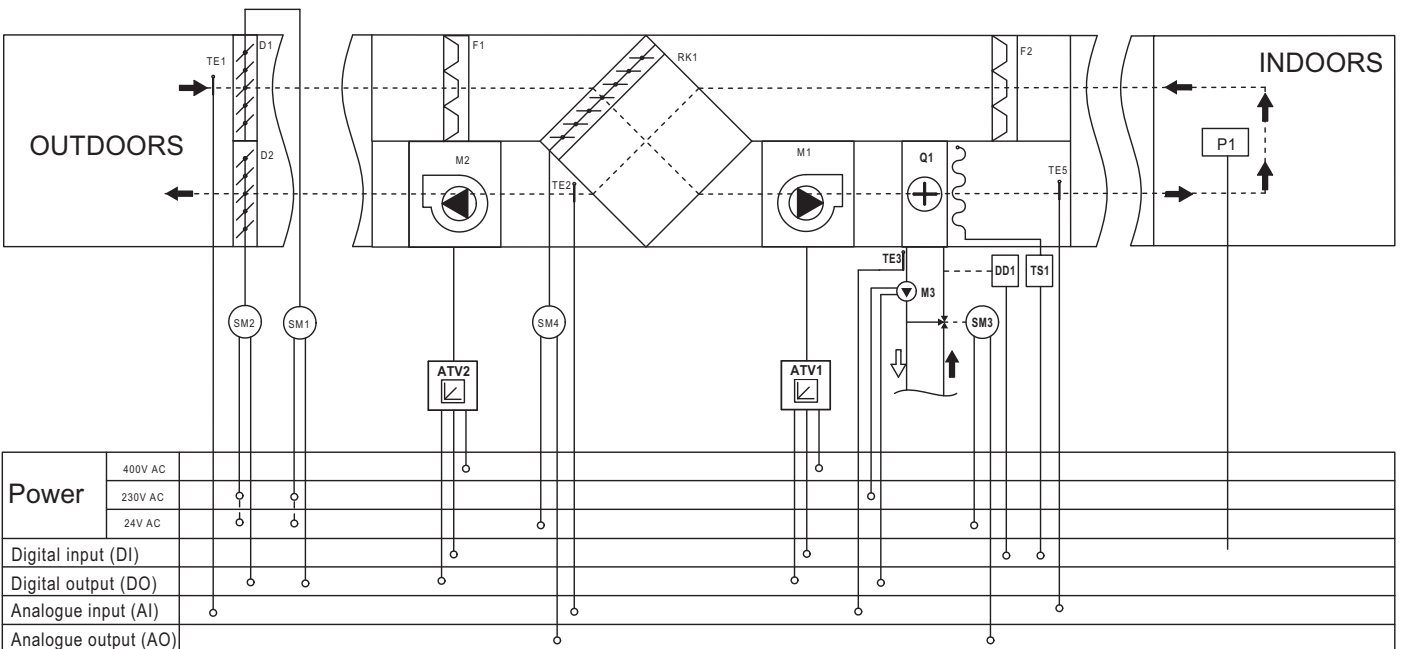

Air handling unit (AC/EC motor) with a water heater, a DX-cooler and a cross-flow heat exchanger

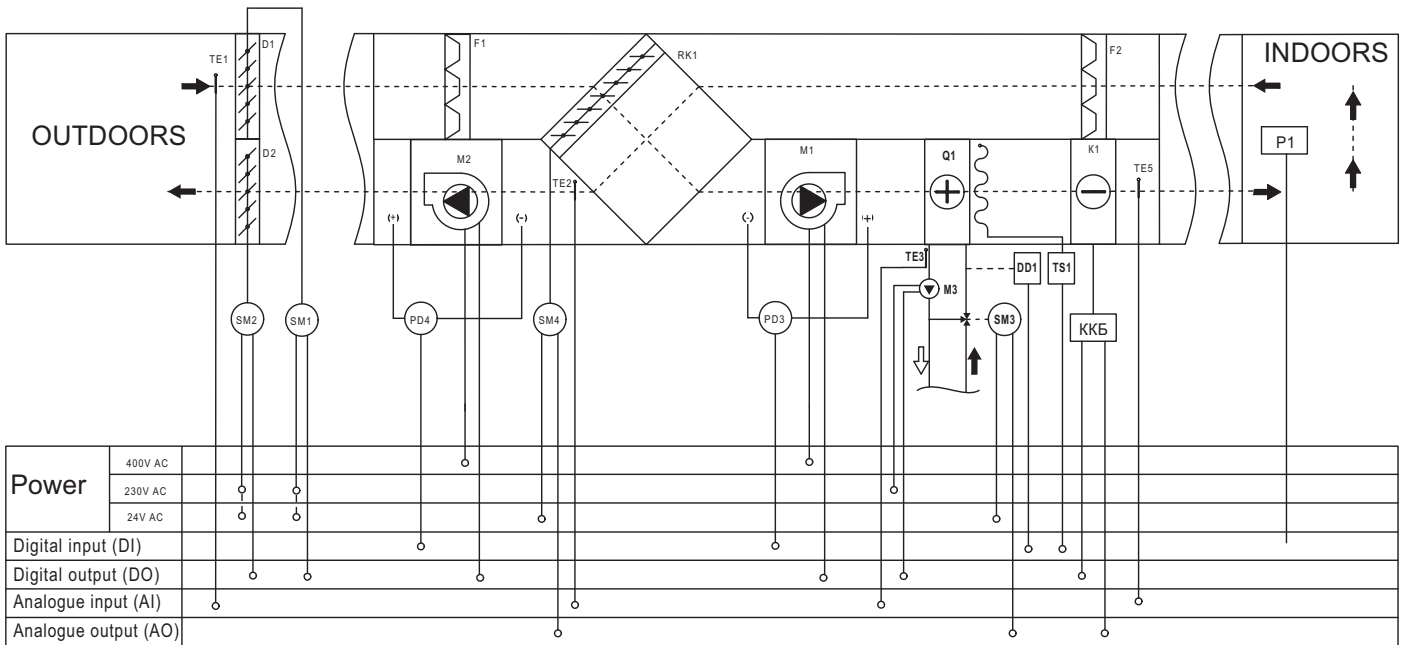

Air handling unit (AC motor with a frequency converter/EC motor) with a water heater, a DX-cooler and a cross-flow heat exchanger

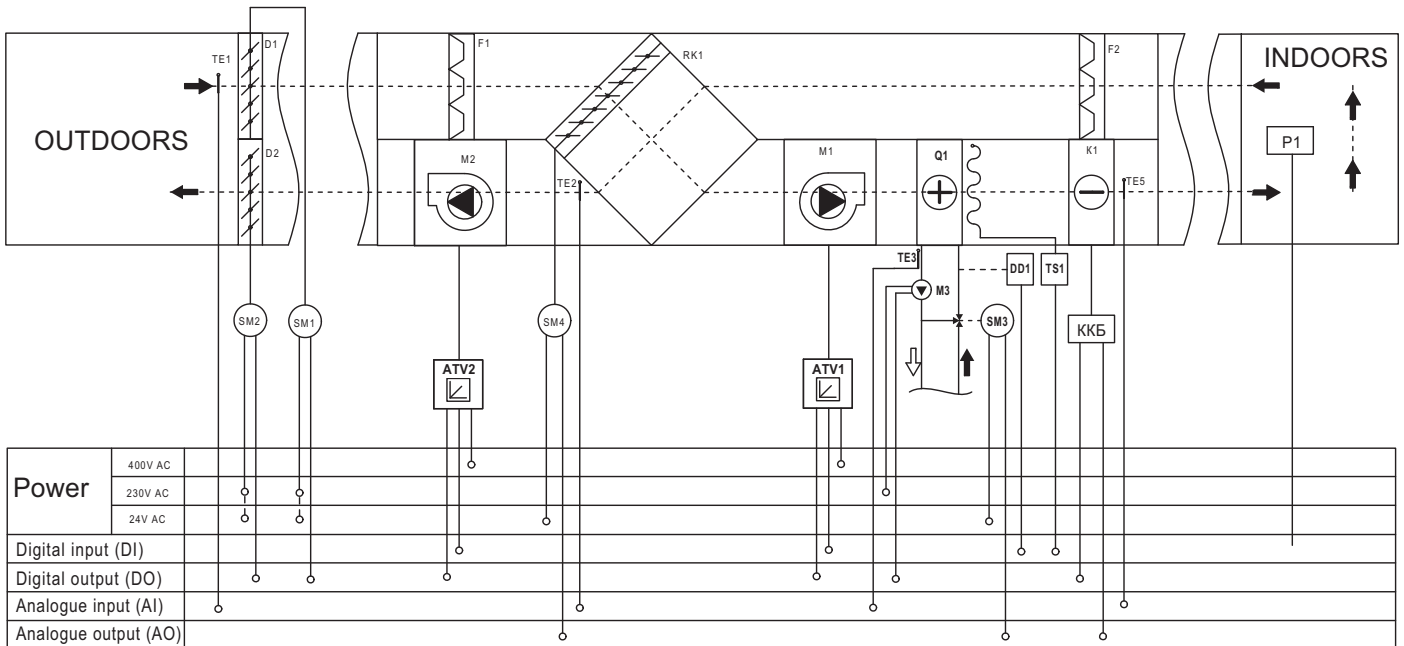

SL-Electric control board of supply/supply and extract ventilation systems with the electric heater

Designed for operating as a part of automation system of supply and air handling units with an electric heater.

Applications

Control boards are designed for a complex control and protection of ventilation and air conditioning systems. Used in conjunction with air handling units equipped with an electric heater, a cross-flow heat exchanger and a DX-cooler. The control board casing encloses the control and protective components of the power section and the automation electronic circuitry. The control board is designed for indoor application in dry environments free of dust and aggressive chemicals.

The control board has the following functions:

- ▶ Switching the electric motors of the unit ON/OFF.
- ▶ Stepless fan speed control.*
- ▶ Controlling the fan operation.
- ▶ Set supply air temperature maintaining (stepless

control of the electric heater*; additional stepped control*).

- ▶ Controlling the heat exchanger bypass damper.
- ▶ Freeze protection of the heat exchanger.
- ▶ Controlling the compressor and condensing unit (CCU) of the air cooler.
- ▶ Supply and extract filters clogging control according to hour meter readings.
- ▶ Controlling the electric actuator of the supply and exhaust air dampers.
- ▶ Automatic control of the ventilation equipment operation using the weekly timer.
- ▶ System shutdown on a signal from fire fighting system.

* Use of an additional external control device is required at ambient temperatures from +5 °C up to +40 °C and relative humidity up to 80%.

Mounting

The control boards are designed for vertical mounting on the wall. Run the cables using cable passages or under plaster. It is possible to connect air damper actuators (with or without a spring return) to the control units. The actuators are available with either 24 V DC or 230 V AC power supply.

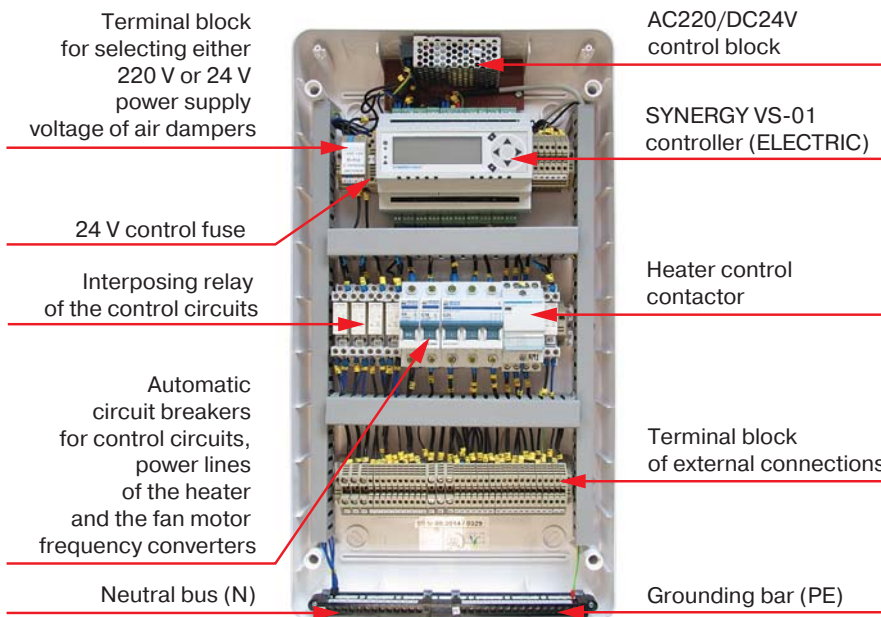

Overall dimensions [mm]

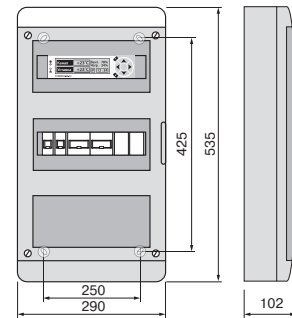

SL-Electric-10.0

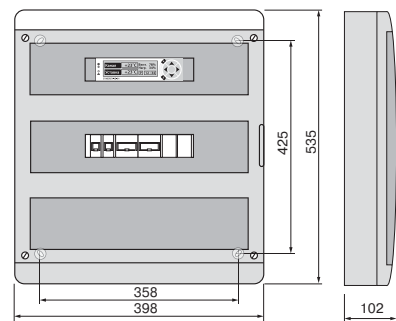

SL-Electric-16.0; SL-Electric-25.0

Accessories



page 110



page 108



page 95



page 94



page 60



page 91



page 96



SINUS M, FC51 frequency converter



SL-Electric-10.0-0.55



SL-Electric-16.0-2.0



SL-Electric-25.0-4.0



SL-Electric-25.0-11.0



SL-Electric-25.0-5.5f



SL-Electric-25.0-11.0f

Designation key on the SL-Electric functional diagrams

Designation	Name	Type
D1	Supply air damper	to be ordered separately
D2	Exhaust air damper	to be ordered separately
F1	Supply filter	pocket type
F2	Extract filter	pocket type
K1	DX-cooler	
M1	Supply fan	to be ordered separately
M2	Extract fan	to be ordered separately
ATV1	Frequency converter of the supply fan	to be ordered separately
ATV2	Frequency converter of the extract fan	to be ordered separately
PD3	Differential pressure switch of the supply fan	NO
PD4	Differential pressure switch of the extract fan	NO
Q1	Electric heater	max. 25 kW
RK1	Cross-flow heat exchanger	
SM1	Supply air damper electric actuator	LM 230 / LM24
SM2	Exhaust air damper electric actuator	LM 230 / LM24
SM4	Bypass damper electric actuator	LM24A
TE1	Outdoor air temperature sensor	NTC
TE2	Temperature sensor downstream of the heat exchanger	NTC
TE5	Duct temperature sensor	NTC
TK50	Thermal contact of the heater	NC
TK90	Response temperature = +50°C	NC
P1	Thermal contact of the heater	Synergy SP-01
	Response temperature = +90°C	
	Control panel	

SL-Electric functional diagrams

Direct-flow system (AC/EC motor) with an electric heater (1 section)

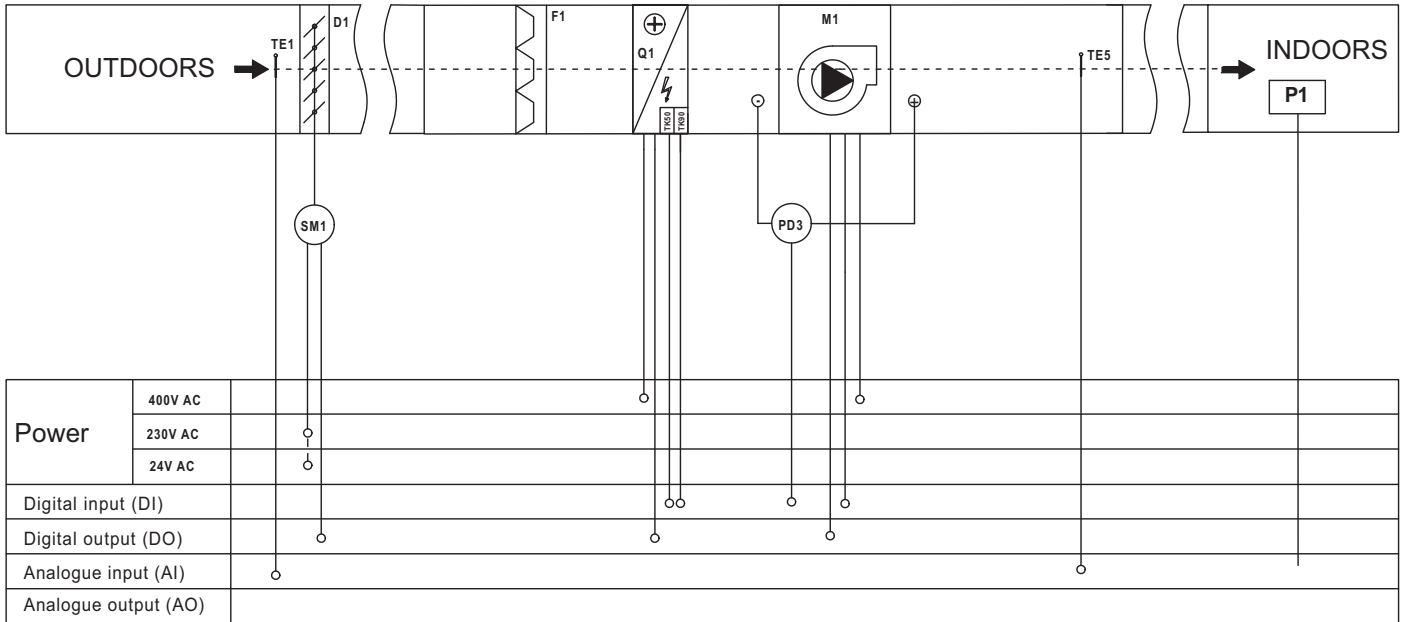

Direct-flow system (AC/EC motor) with an electric heater (1 section)
(SL-Electric-25.0-5.5f and SL-Electric-25.0-11.0f)

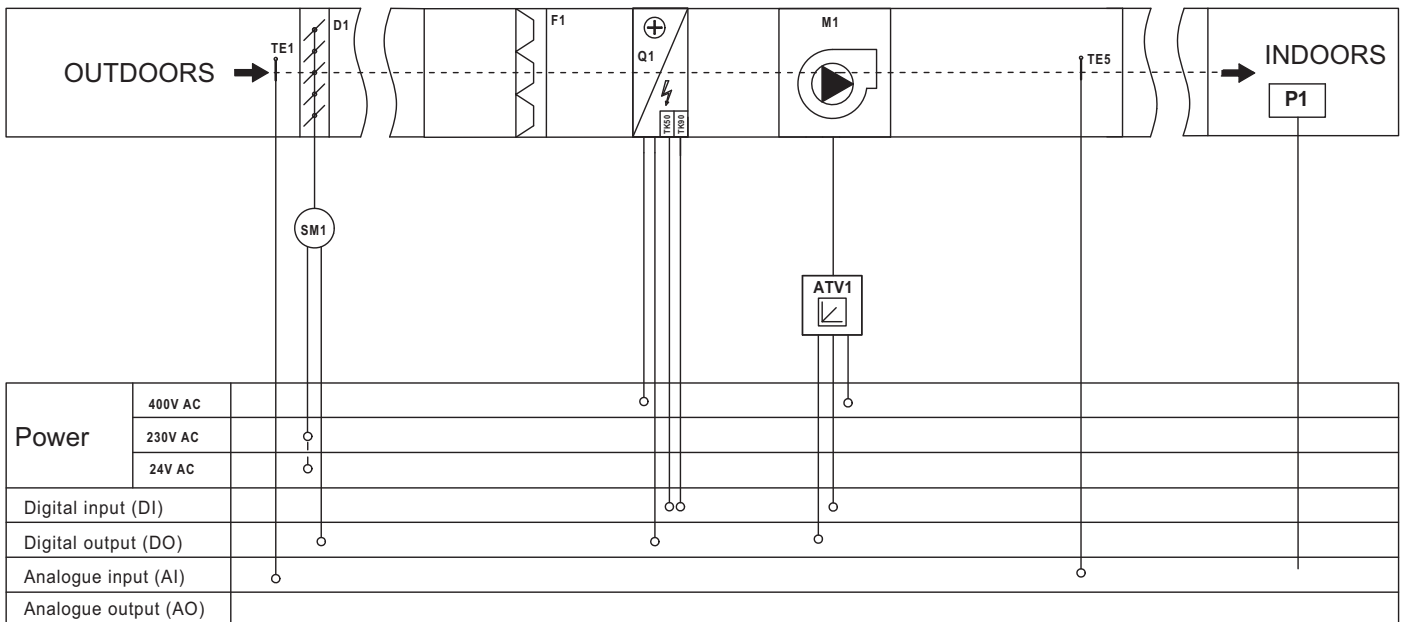

Direct-flow system (AC/EC motor) with an electric heater (1 section) and a DX-cooler

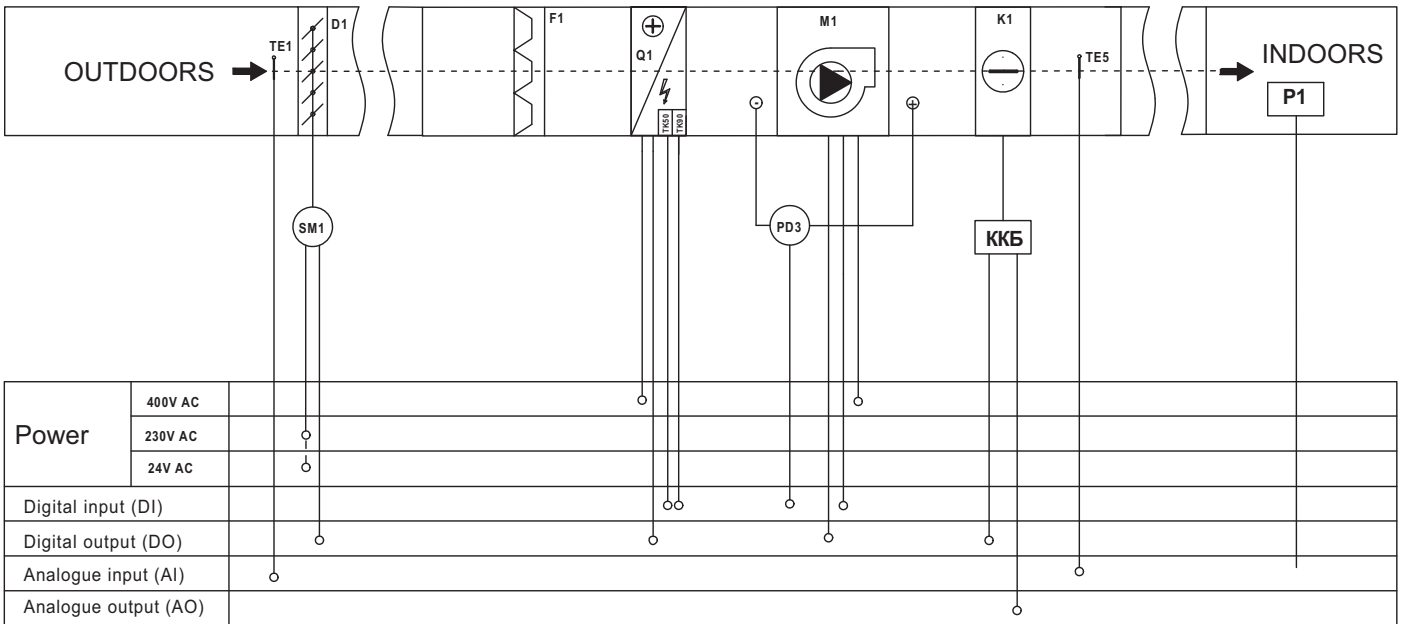

Direct-flow system (AC motor with a frequency converter/EC motor) with an electric heater (1 section) and a DX-cooler (SL-Electric-25.0-5.5f and SL-Electric-25.0-11.0f)

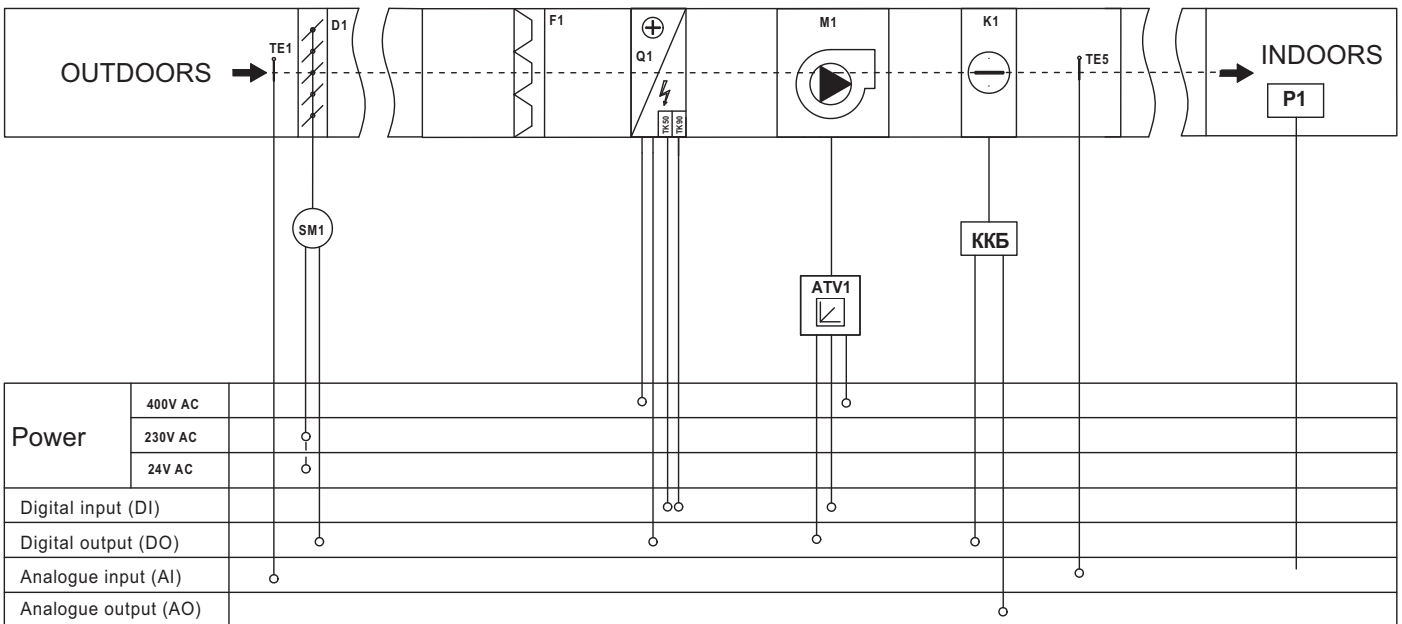

Supply and extract system (AC/EC motor) with an electric heater (1 section)

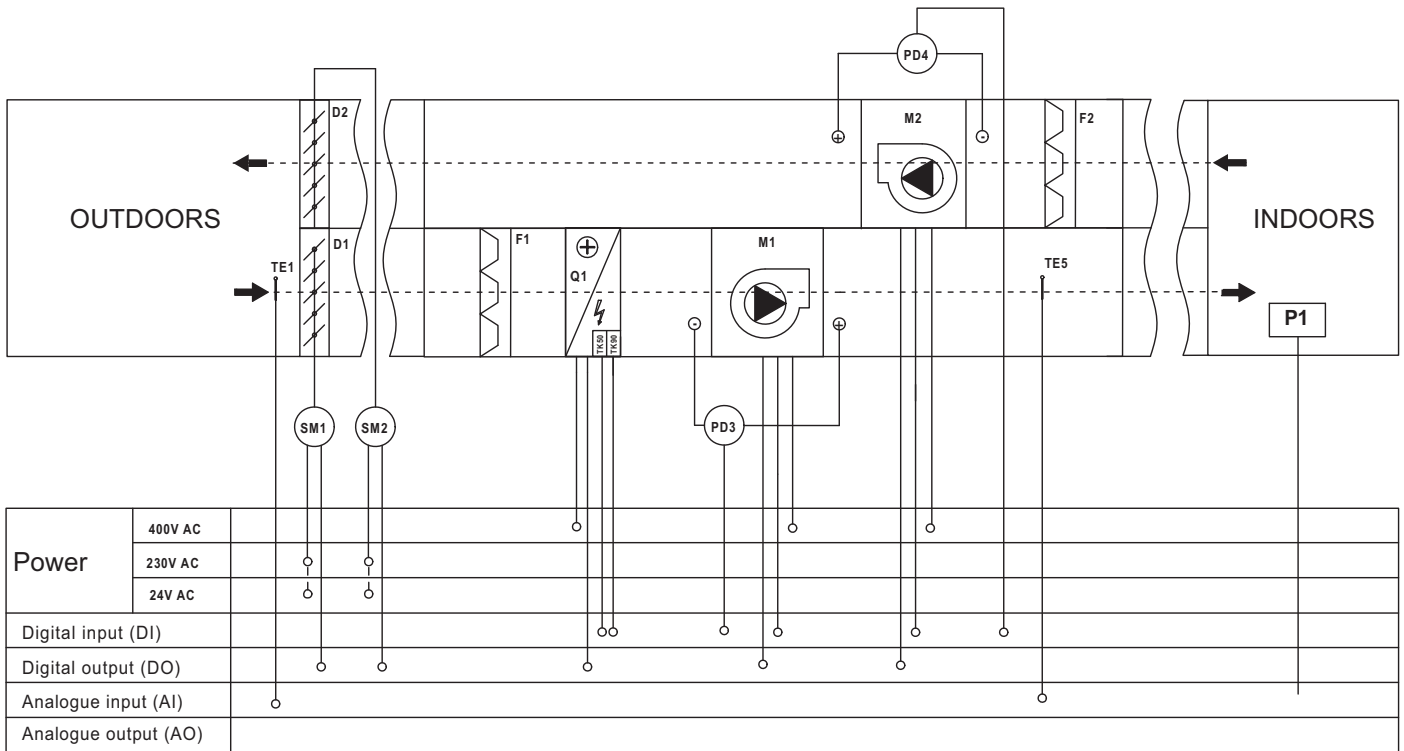

Supply and extract system (AC motor with a frequency converter/EC motor) with an electric heater (1 section)

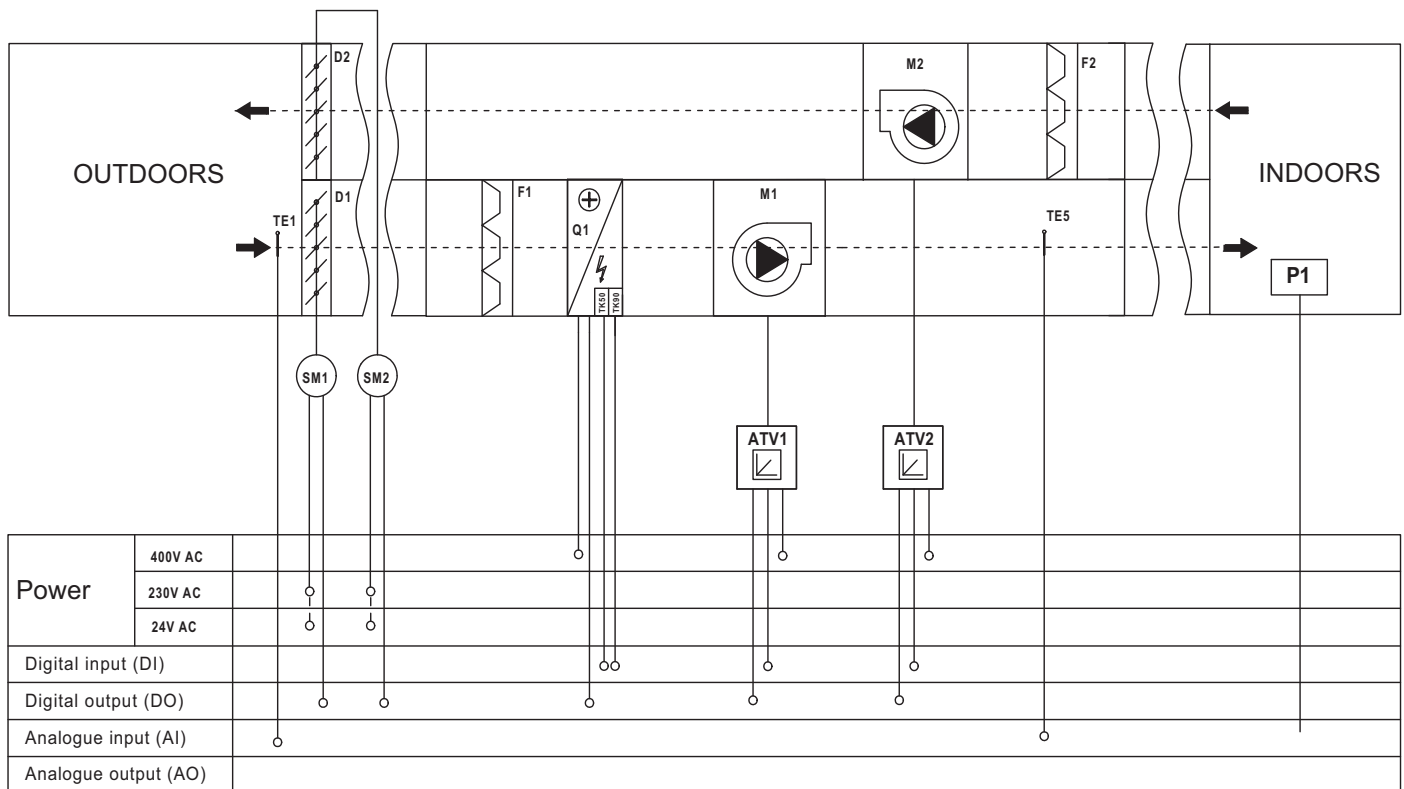

Air handling unit (AC/EC motor) with an electric heater (1 section) and a DX-cooler

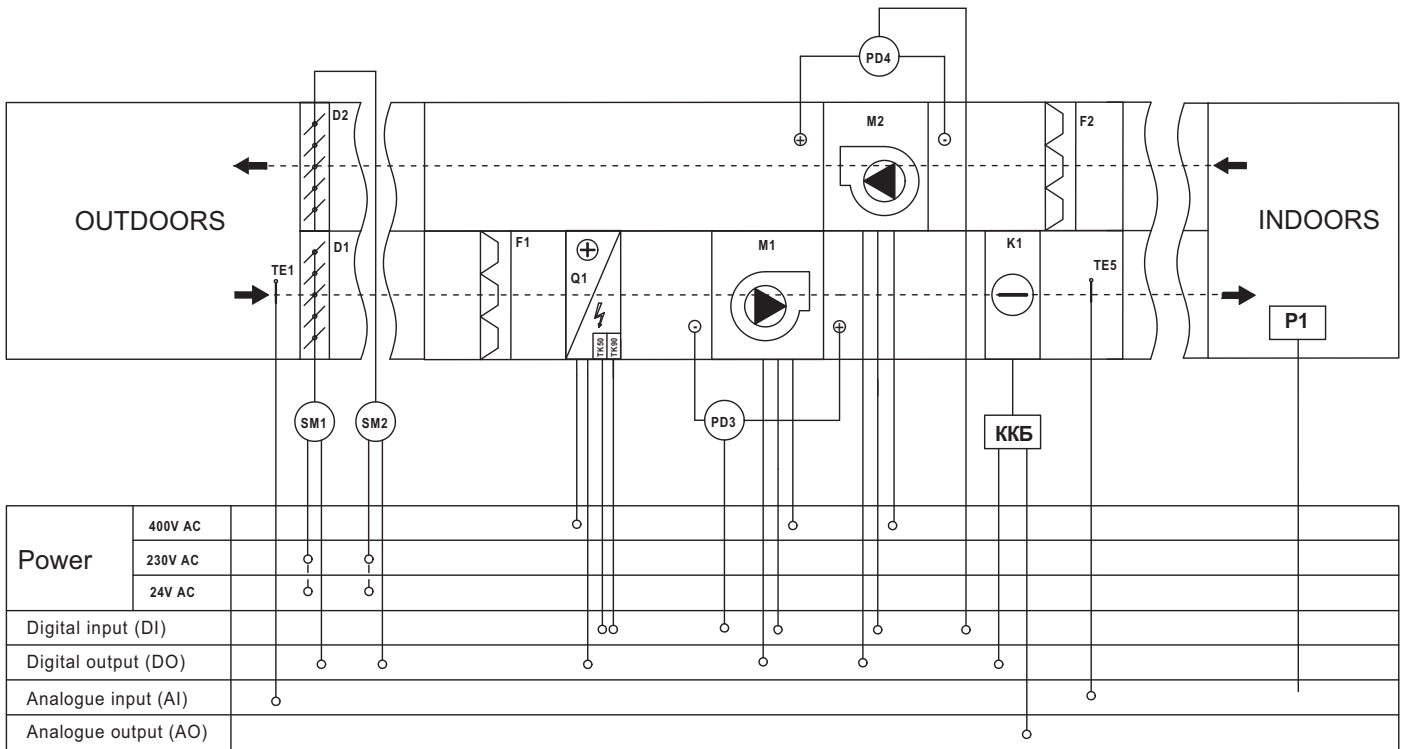

Air handling unit (AC motor with a frequency converter/ EC motor) with an electric heater (1 section) and a DX-cooler

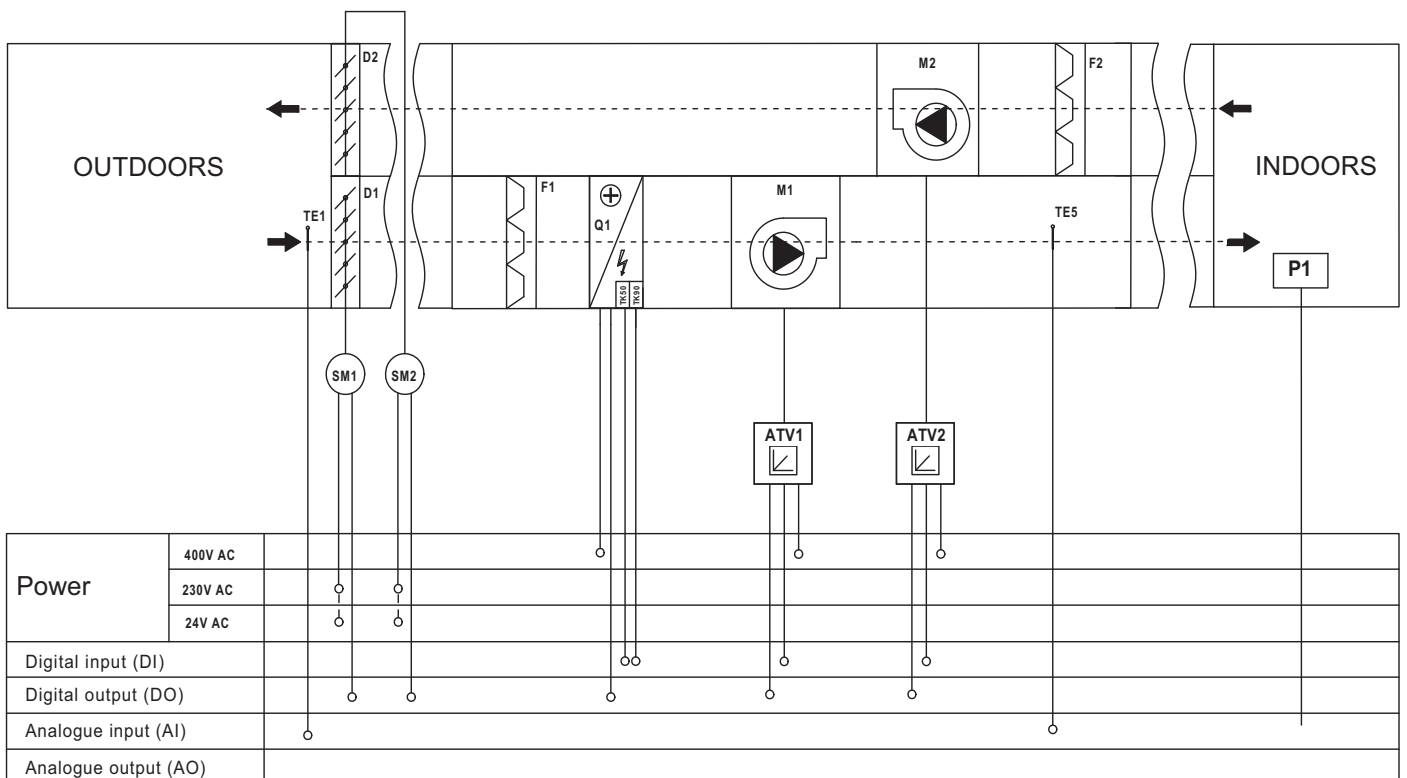

Air handling unit (AC/EC motor) with an electric heater (1 section), a DX-cooler and a cross-flow heat exchanger

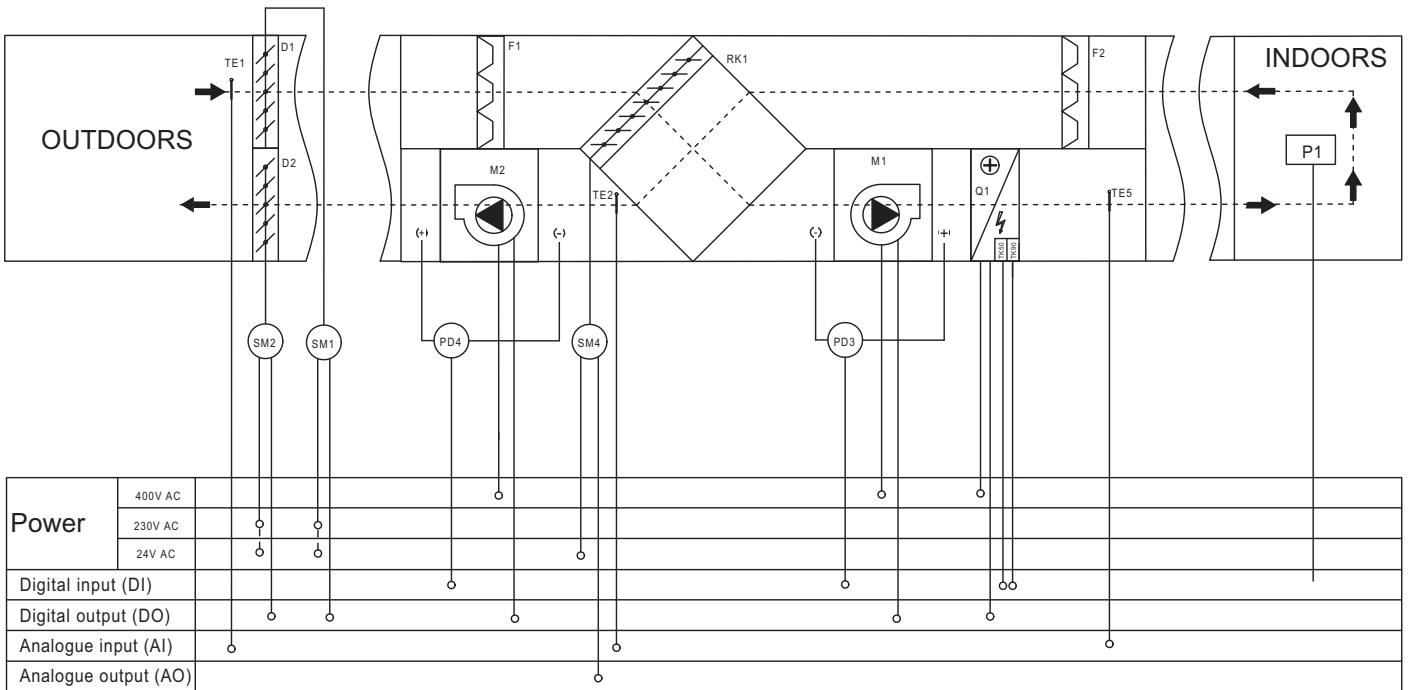

Air handling unit (AC motor with a frequency converter/ EC motor) with an electric heater (1 section), a DX-cooler and a cross-flow heat exchanger

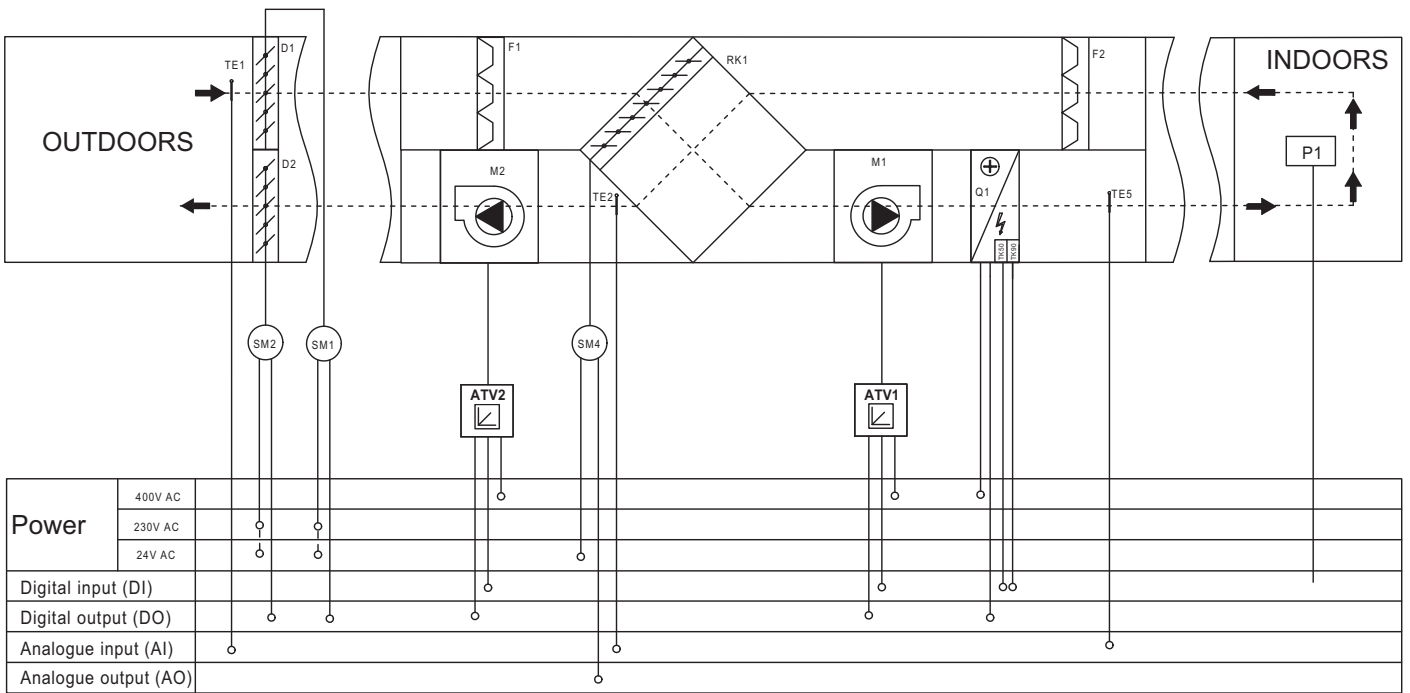

Air handling unit (AC/EC motor) with an electric heater (1 section), a DX-cooler and a cross-flow heat exchanger

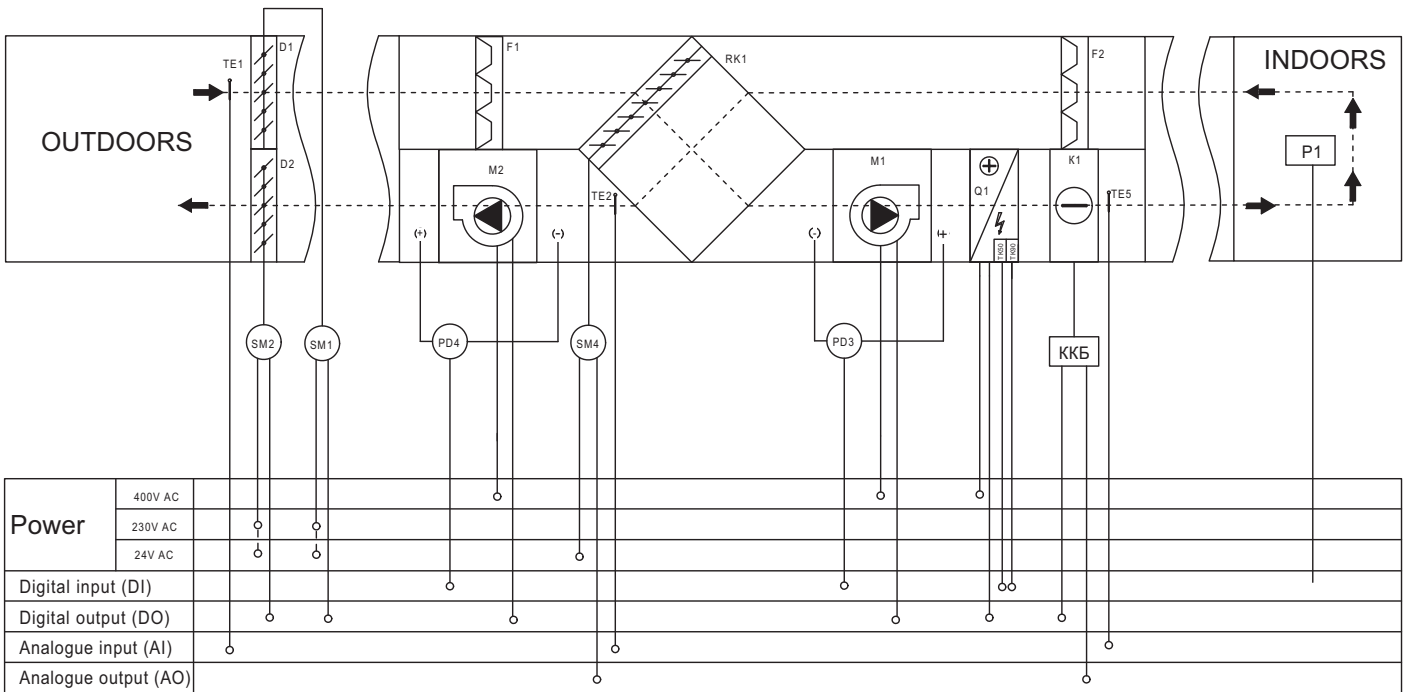

Air handling unit (AC motor with a frequency converter/ EC motor) with an electric heater (1 section), a DX-cooler and a cross-flow heat exchanger

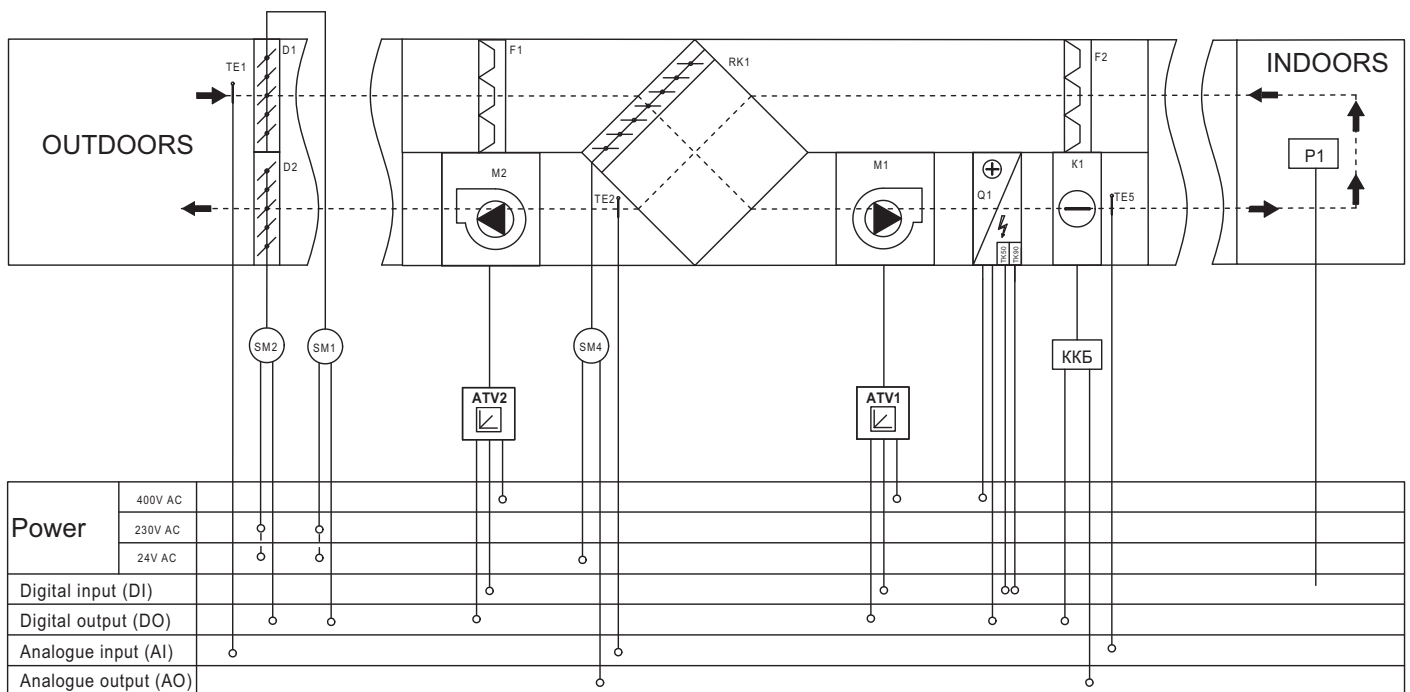

Application example

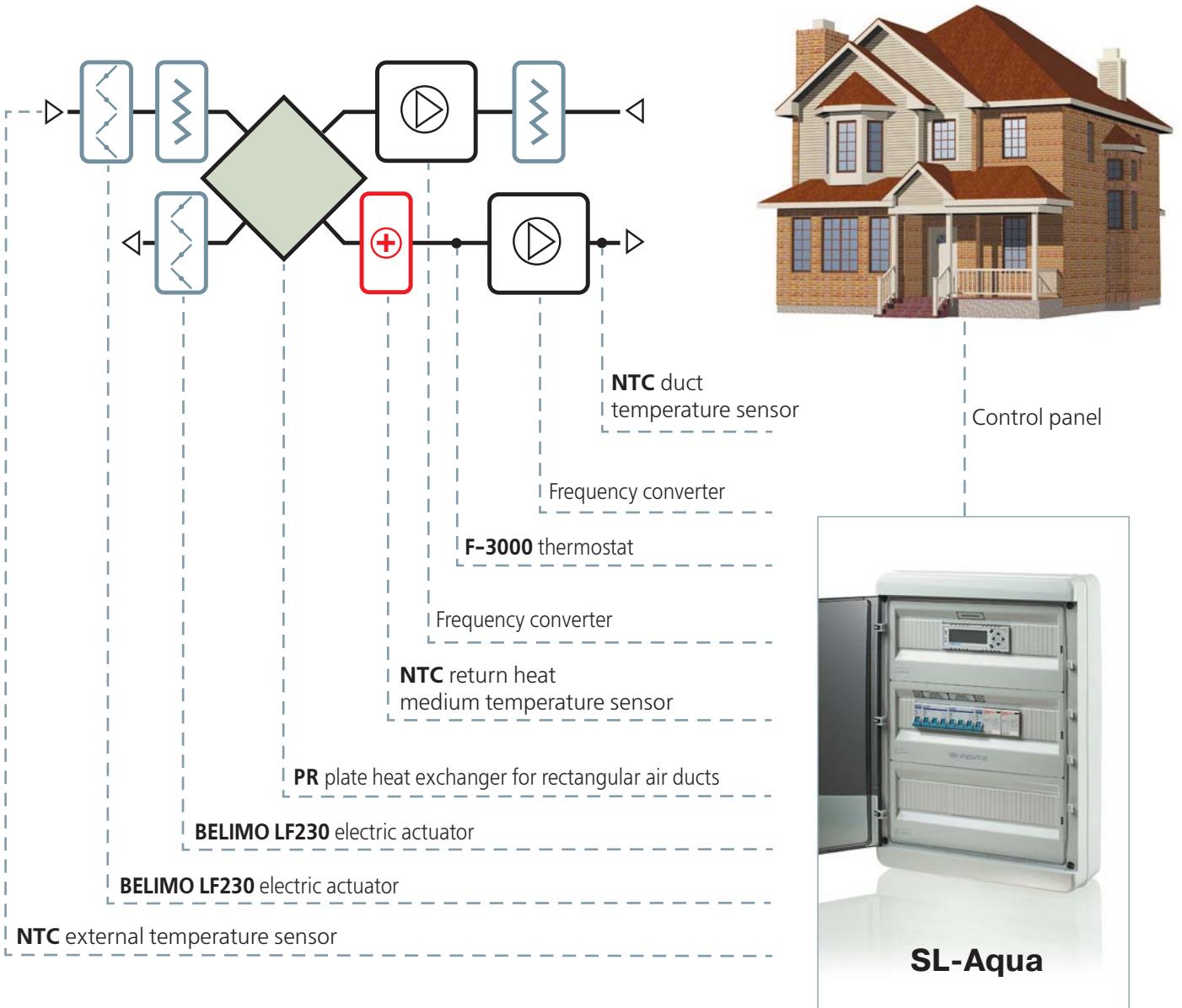



St. Paraskeva Medical Center, Lviv.
Installed equipment



Alex Pab, Kyiv.
Installed equipment



OBJECTS

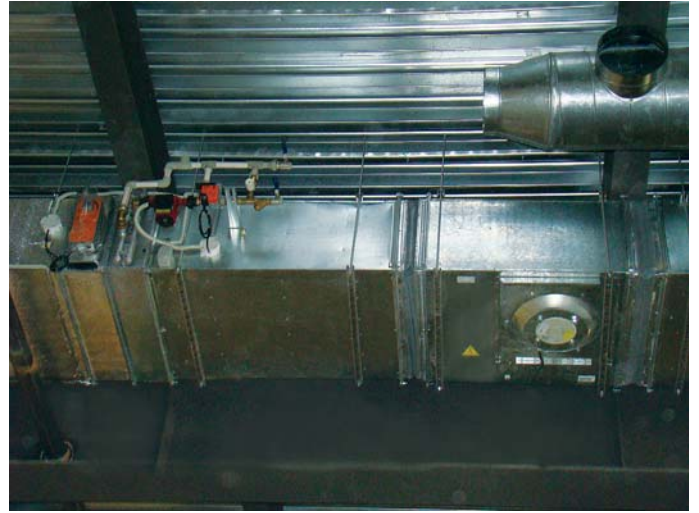

Residential house, Brovary, Kyiv region. Installed equipment



"Metallist" Stadium, Kharkiv

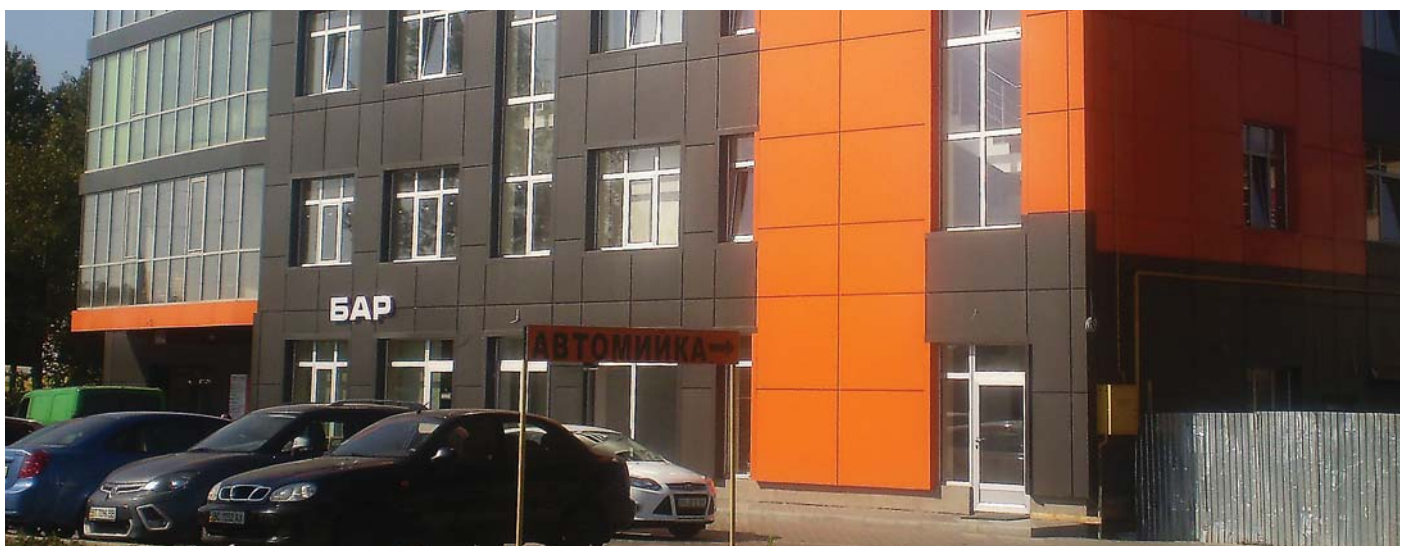

Car service station, Lviv



Elementary general education school "Liko school", Kyiv. Installed equipment

OBJECTS



Mitsubishi car showroom, Kyiv. Installed equipment



Mink farm, Yerkovtsy. Installed equipment



Restaurant in Gora, Kyiv region. Installed equipment



Cacao Blus Cafe, Kyiv. Installed equipment

OBJECTS



Vapiano restaurant, Lviv, Ukraine
AirVENTS



Christophor restaurant, Lviv, Ukraine
X-Vent system

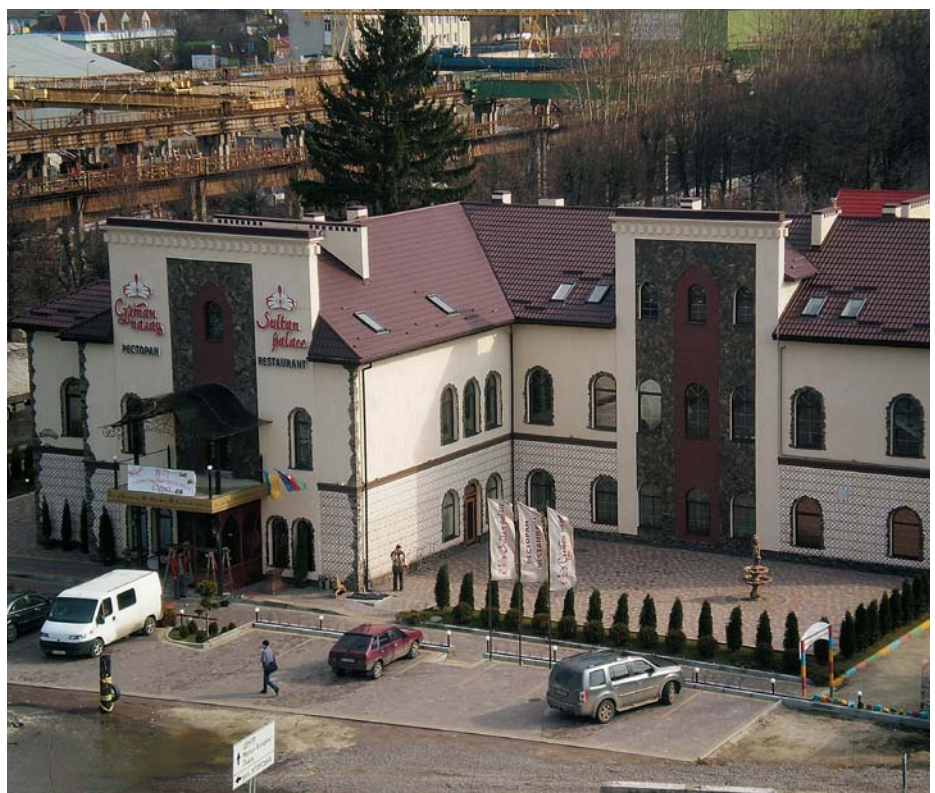

Sultan Palace restaurant, Lviv, Ukraine
Air handling unit, X-Vent system

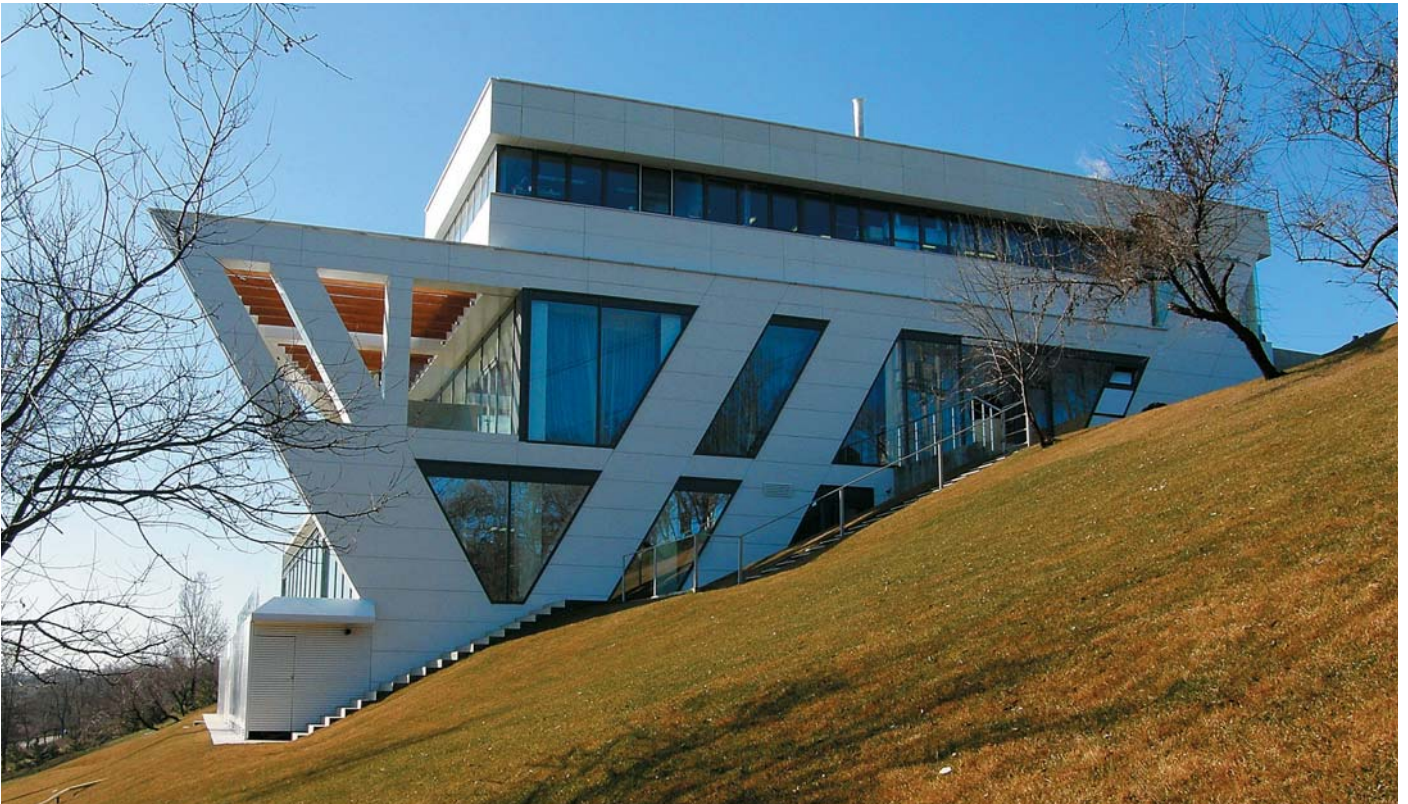

Sea Grill restaurant, Odessa, Ukraine
X-Vent system



Bruderschaft restaurant, Lviv, Ukraine
X-Vent system

