

METAL GRILLES MVM

РЕШЕТКИ МЕТАЛЛИЧЕСКИЕ МВМ

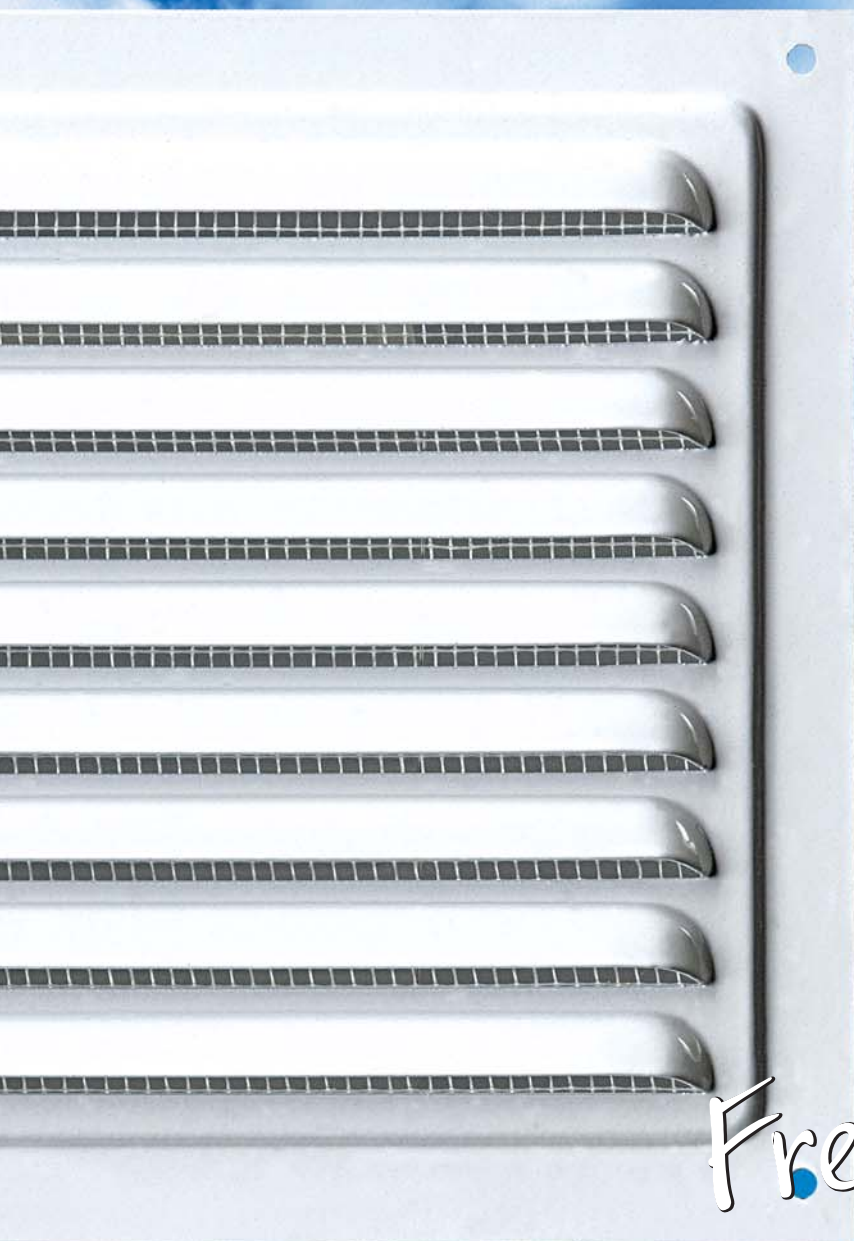

*Fresh air in
your house!*

*Свежий воздух
в Вашем доме!*

VENTS  **ВЕНТС**





Metal grilles
Решетки металлические.....2



Metal grilles (plain)
Решетки металлические (плоские)3



Metal grilles (plain)
Решетки металлические (плоские).....4-5



Metal grilles (bended)
Решетки металлические (отбортованные).....6-7



Metal grilles (bended)
Решетки металлические (отбортованные).....8



Metal grilles (bended)
Решетки металлические (отбортованные).....9



Metal grilles (door)
Решетки металлические (дверные).....10-11



Metal grilles (adjustable)
Решетки металлические (регулируемые).....12



Metal grilles (adjustable)
Решетки металлические (регулируемые).....13









Metal grilles (double)
Решетки металлические (двойные).....14



Metal grilles (double)
Решетки металлические (двойные).....15







-  • specially designed for combined extract and input ventilation
- для приточно-вытяжной вентиляции
- pour ventilation par refoulement et extraction
- für die zuluft und abfuhrleitung
-  • specially designed both for internal and external mounting
- для внутреннего и наружного монтажа
- installation intérieure et extérieure
- für innere und äußere montage
-  • screw fastening
- крепление при помощи шурупов
- fixation à l'aide de vis
- befestigung mit hilfe der verschraubungen
-  • weather resistant
- устойчива к атмосферным воздействиям
- stable à influence atmosphérique
- zu den atmosphärischen einwirkungen standfest
-  • anti-mosquito screen (upon request)
- защитная сетка от насекомых (по требованию)
- toile moustiquaire (à la demande)
- antiinsektennetz (nach forderung)
-  • metal (steel, aluminum)
- металл (сталь, алюминий)
- métal (acier, aluminium)
- metall (stahl, aluminium)

Type	Тип	L	H	l	h	air pass, cm ²	
MVM 125	MVM 125	125	125	111	111	35	40
MVM 150	MVM 150	150	150	136	136	60	40
MVM 200	MVM 200	200	200	182	182	117	30
MVM 250	MVM 250	250	250	234	234	166	20
MVM 300	MVM 300	300	300	284	284	249	18

Material / Исполнение

- | | | | |
|---|--|---|---|
|  steel painted
сталь окрашенная
acier coloré
stahl gefärbtes |  Zn / Ц galvanized steel
сталь оцинкованная
acier galvanisé
verzinkter stahl |  A aluminium
алюминий
aluminium
aluminium |  A aluminium painted
алюминий окрашенный
aluminium coloré
gefärbtes aluminium |
|---|--|---|---|

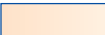
Colours / Цветовая гамма

- | | | | | | |
|--|--|---|--|---|--|
|  white
белый
blanc
weiß
RAL 9016 |  brown
коричневый
brun
braun
RAL 9017 |  blue
синий
bleu
blau
RAL 5005 |  beige
бежевый
beige
beige
RAL 1015 |  grey
серый
gris
grau
RAL 7001 |  black
черный
noir
schwarz
RAL 9005 |
|--|--|---|--|---|--|



- specially designed for combined extract and input ventilation
 - для приточно-вытяжной вентиляции
 - pour ventilation par refoulement et extraction
 - für die zufuhr und abfuhrleitung
- specially designed both for internal and external mounting
 - для внутреннего и наружного монтажа
 - installation intérieure et extérieure
 - für innere und äußere montage
- screw fastening
 - крепление при помощи шурупов
 - fixation à l'aide de vis
 - befestigung mit hilfe der verschraubungen
- weather resistant
 - устойчива к атмосферным воздействиям
 - stable à influence atmosphérique
 - zu den atmosphärischen einwirkungen standfest
- anti-mosquito screen (upon request)
 - защитная сетка от насекомых (по требованию)
 - toile moustiquaire (à la demande)
 - antiinsektennetz (nach forderung)
- metal (steel, aluminum)
 - металл (сталь, алюминий)
 - métal (acier, aluminium)
 - metall (stahl, aluminium)

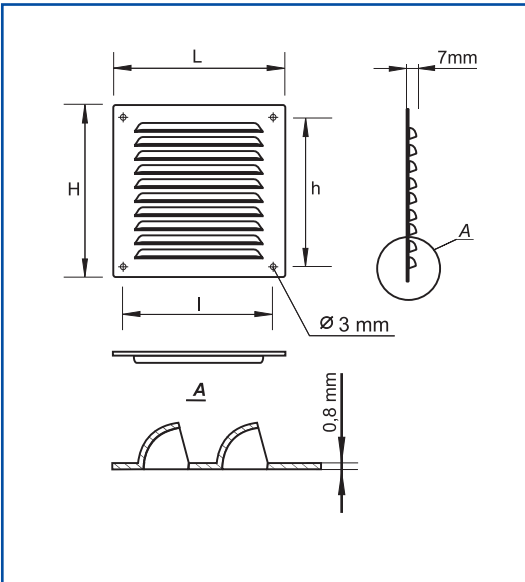

Type	Тип	L	H	l	h	air pass, cm ²	
MVMP 70*140	МВМП 70*140	70	140	56	126	18	25
MVMP 100	МВМП 100	100	100	86	86	18	25
MVMP 100*200	МВМП 100*200	100	200	86	186	50	25
MVMP 100*300	МВМП 100*300	100	300	86	288	81	25
MVMP 130*90	МВМП 130*90	130	90	116	76	19	25
MVMP 150	МВМП 150	150	150	136	136	36	25
MVMP 150*200	МВМП 150*200	150	200	136	186	54	25
MVMP 150*210	МВМП 150*210	150	210	136	196	54	25
MVMP 150*300	МВМП 150*300	150	300	136	286	81	25
MVMP 175	МВМП 175	175	175	161	161	45	25
MVMP 175*250	МВМП 175*250	175	250	161	236	68	25

Material / Исполнение

steel painted
сталь окрашенная
acier coloré
stahl gefärbtes

Zn / Ц galvanized steel
сталь оцинкованная
acier galvanisé
verzinkter stahl

A aluminium
алюминий
aluminium
aluminium

A aluminium painted
алюминий окрашенный
aluminium coloré
gefärbtes aluminium

Colours / Цветовая гамма

white
белый
blanc
weiß
RAL 9016

brown
коричневый
brun
braun
RAL 9017

blue
синий
bleu
blau
RAL 5005

beige
бежевый
beige
beige
RAL 1015

grey
серый
gris
grau
RAL 7001

black
черный
noir
schwarz
RAL 9005

METAL GRILLES (PLAIN) РЕШЕТКИ МЕТАЛЛИЧЕСКИЕ (ПЛОСКИЕ)



- specially designed for combined extract and input ventilation
• для приточно-вытяжной вентиляции
• pour ventilation par refoulement et extraction
• für die zufuhr und abfuhrlüftung
- specially designed both for internal and external mounting
• для внутреннего и наружного монтажа
• installation intérieure et extérieure
• für innere und äußere montage
- screw fastening
• крепление при помощи шурупов
• fixation à l'aide de vis
• befestigung mit hilfe der verschraubungen
- weather resistant
• устойчива к атмосферным воздействиям
• stable à influence atmosphérique
• zu den atmosphärischen einwirkungen standfest
- anti-mosquito screen (upon request)
• защитная сетка от насекомых (по требованию)
• toile moustiquaire (à la demande)
• antiinsektennetz (nach forderung)
- metal (steel, aluminum)
• металл (сталь, алюминий)
• métal (acier, aluminium)
• metall (stahl, aluminium)

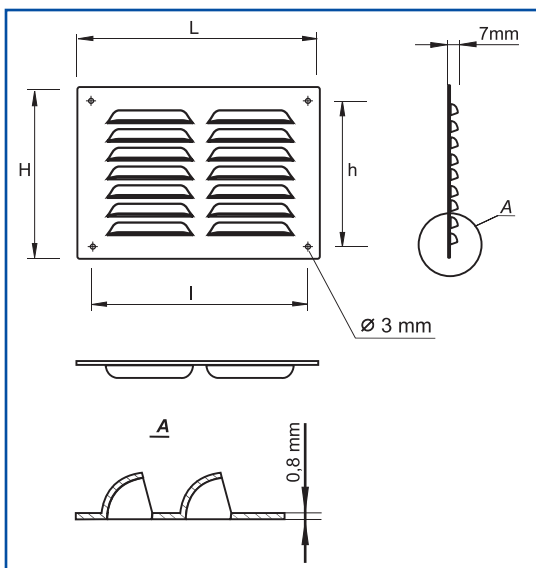

Type	Тип	L	H	l	h	air pass, cm ²	
MVMP 200*100	МВМП 200*100	200	100	186	186	36	25
MVMP 200	МВМП 200	200	200	186	186	99	25
MVMP 200*300	МВМП 200*300	200	300	186	286	162	25
MVMP 240	МВМП 240	240	240	226	226	126	25
MVMP 240*140	МВМП 240*140	240	140	226	126	63	25
MVMP 240*190	МВМП 240*190	240	190	226	176	99	25
MVMP 250	МВМП 250	250	250	236	236	135	25
MVMP 250*300	МВМП 250*300	250	300	236	286	171	25

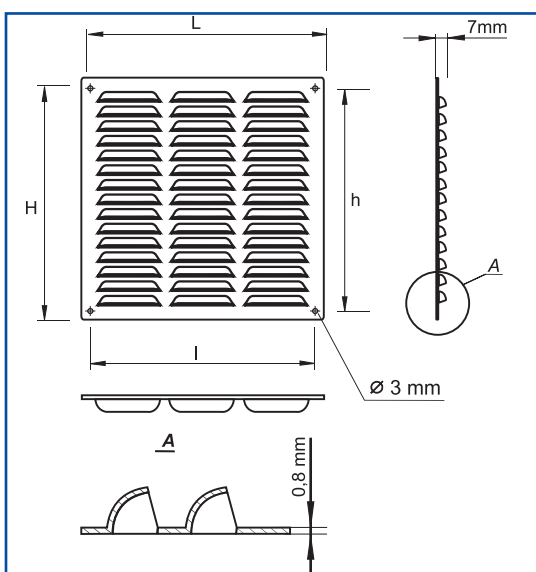

Type	Тип	L	H	l	h	air pass, cm ²	
MVMP 300*100	МВМП 300*100	300	100	286	86	54	25
MVMP 300*210	МВМП 300*210	300	210	286	196	162	25
MVMP 300*250	МВМП 300*250	300	250	286	236	189	25
MVMP 300*290	МВМП 300*290	300	290	286	276	230	25
MVMP 300	МВМП 300	300	300	286	286	243	25

Material / Исполнение



steel painted
сталь окрашенная
acier coloré
stahl gefärbtes

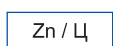

galvanized steel
сталь оцинкованная
acier galvanisé
verzinkter stahl



aluminium
алюминий
aluminium
aluminium



aluminium painted
алюминий окрашенный
aluminium coloré
gefärbtes aluminium

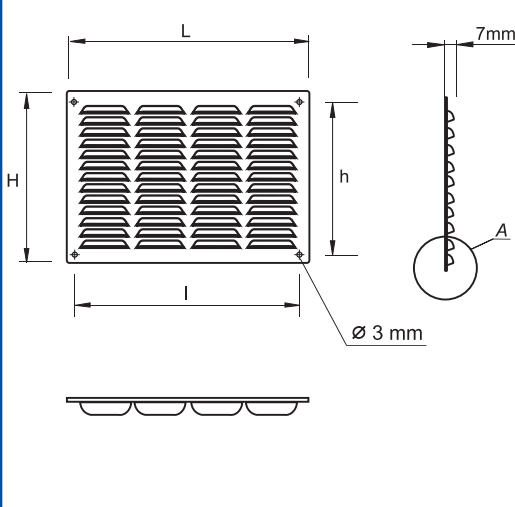

Туре	Тип	L	H	l	h	air pass, cm ²	
MVMP 400*300	МВМП 400*300	400	300	386	286	324	25

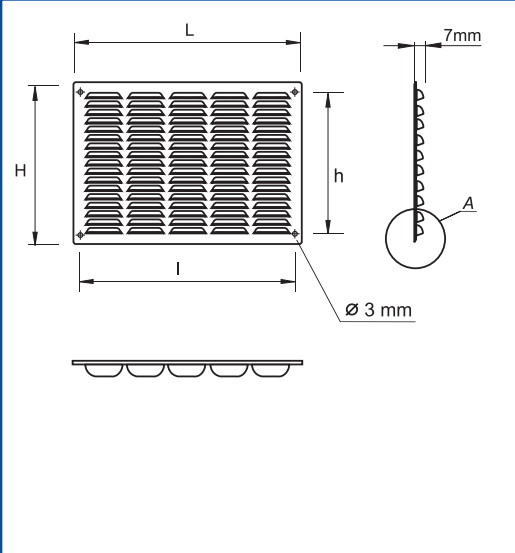

Туре	Тип	L	H	l	h	air pass, cm ²	
MVMP 500*400	МВМП 500*400	500	400	486	386	563	25

Colours / Цветовая гамма

	white белый blanc weiß		brown коричневый brun braun		blue синий bleu blau		beige бежевый beige beige		grey серый gris grau		black черный noir schwarz
RAL 9016		RAL 9017		RAL 5005		RAL 1015		RAL 7001		RAL 9005	

METAL GRILLES (BENDED) РЕШЕТКИ МЕТАЛЛИЧЕСКИЕ (ОТБОРТОВАННЫЕ)



- specially designed for combined extract and input ventilation
• для приточно-вытяжной вентиляции
• pour ventilation par refolement et extraction
• für die zufuhr und abfuhrlüftung
- specially designed both for internal and external mounting
• для внутреннего и наружного монтажа
• installation intérieure et extérieure
• für innere und äußere montage
- screw fastening
• крепление при помощи шурупов
• fixation à l'aide de vis
• befestigung mit hilfe der verschraubungen
- weather resistant
• устойчива к атмосферным воздействиям
• stable à influence atmosphérique
• zu den atmosphärischen einwirkungen standfest
- anti-mosquito screen (upon request)
• защитная сетка от насекомых (по требованию)
• toile moustiquaire (à la demande)
• antiinsektennetz (nach forderung)
- metal (steel, aluminum)
• металл (сталь, алюминий)
• métal (acier, aluminium)
• metall (stahl, aluminium)

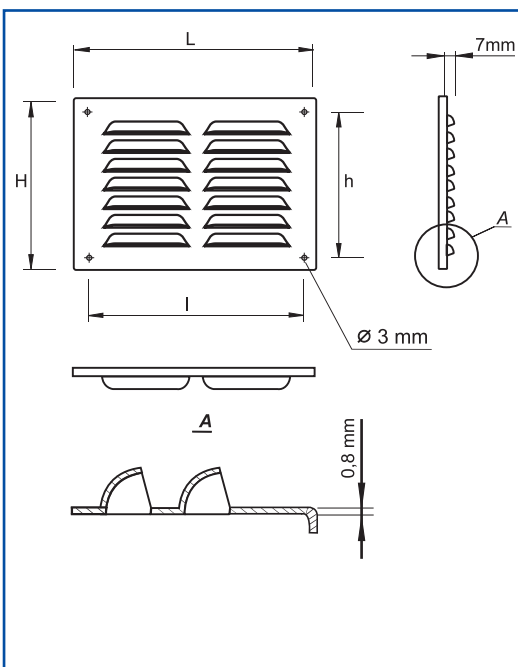

Type	Тип	L	H	l	h	air pass, cm ²	
MVMPO 195*245	МВМПО 195*245	195	245	181	231	135	25
MVMPO 200	МВМПО 200	200	200	186	186	99	25
MVMPO 215*150	МВМПО 215*150	215	150	201	136	72	25
MVMPO 240	МВМПО 240	240	240	226	226	126	25
MVMPO 240*165	МВМПО 240*165	240	165	226	151	81	25
MVMPO 245*195	МВМПО 245*195	245	195	231	181	99	25
MVMPO 250	МВМПО 250	250	250	236	236	135	25
MVMPO 250*300	МВМПО 250*300	250	300	236	286	162	25

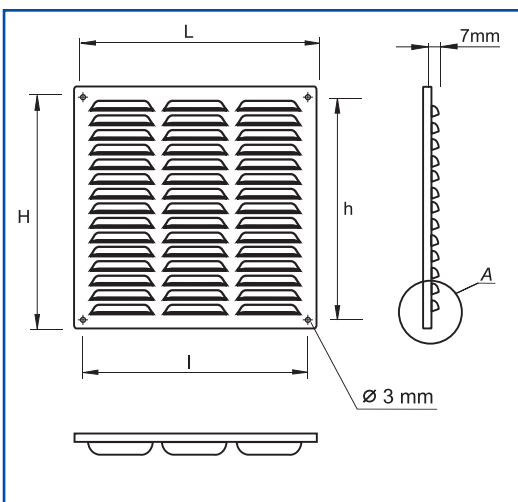

Type	Тип	L	H	l	h	air pass, cm ²	
MVMPO 300	МВМПО 300	300	300	286	286	243	25

Material / Исполнение

- steel painted
сталь окрашенная
acier coloré
stahl gefärbtes
- Zn / Ц galvanized steel
сталь оцинкованная
acier galvanisé
verzinkter stahl
- A aluminium
алюминий
aluminium
aluminium
- A aluminium painted
алюминий окрашенный
aluminium coloré
gefärbtes aluminium

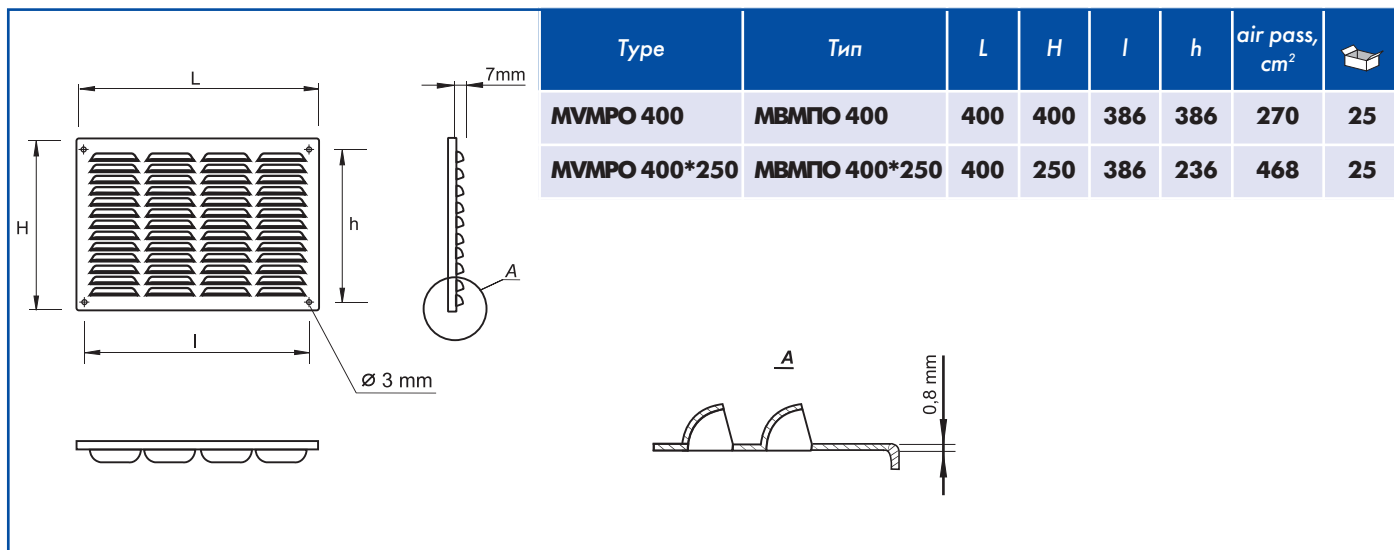







Colours / Цветовая гамма

	white белый blanc weiß		brown коричневый brun braun		blue синий bleu blau		beige бежевый beige beige		grey серый gris grau		black черный noir schwarz
RAL 9016		RAL 9017		RAL 5005		RAL 1015		RAL 7001		RAL 9005	

METAL GRILLES (BENDED) РЕШЕТКИ МЕТАЛЛИЧЕСКИЕ (ОТБОРТОВАННЫЕ)



-  • specially designed for combined extract and input ventilation
• для приточно-вытяжной вентиляции
• pour ventilation par refoulement et extraction
• für die zuluft und abfuhrleitung
-  • specially designed both for internal and external mounting
• для внутреннего и наружного монтажа
• installation intérieure et extérieure
• für innere und äußere montage
-  • screw fastening
• крепление при помощи шурупов
• fixation à l'aide de vis
• befestigung mit hilfe der verschraubungen
-  • weather resistant
• устойчива к атмосферным воздействиям
• stable à influence atmosphérique
• zu den atmosphärischen einwirkungen standfest
-  • anti-mosquito screen (upon request)
• защитная сетка от насекомых (по требованию)
• toile moustiquaire (à la demande)
• antiinsektennetz (nach forderung)
-  • metal (steel, aluminum)
• металл (сталь, алюминий)
• métal (acier, aluminium)
• metall (stahl, aluminium)

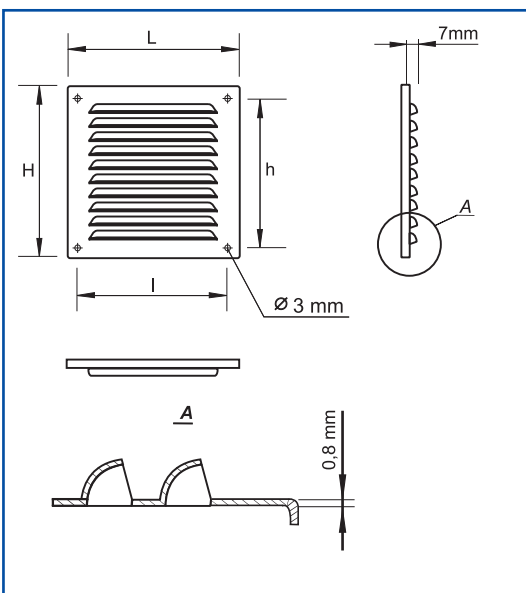

Type	Тип	L	H	l	h	air pass, cm ²	
MVMPO 70*140	МВМПО 70*140	70	140	56	126	18	25
MVMPO 100	МВМПО 100	100	100	86	86	18	25
MVMPO 100*200	МВМПО 100*200	100	200	86	186	50	25
MVMPO 100*300	МВМПО 100*300	100	302	86	288	86	25
MVMPO 125	МВМПО 125	125	125	111	111	33	25
MVMPO 130*90	МВМПО 130*90	130	90	116	76	18	25
MVMPO 140	МВМПО 140	140	140	126	126	36	25
MVMPO 140*180	МВМПО 140*180	140	180	126	166	45	25
MVMPO 140*240	МВМПО 140*240	140	240	126	226	63	25
MVMPO 150*215	МВМПО 150*215	150	215	136	201	59	25
MVMPO 155	МВМПО 155	155	155	141	141	41	25

Material / Исполнение



steel painted
сталь окрашенная
acier coloré
stahl gefärbtes

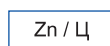

galvanized steel
сталь оцинкованная
acier galvanisé
verzinkter stahl

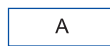

aluminium
алюминий
aluminium
aluminium



aluminium painted
алюминий окрашенный
aluminium coloré
gefärbtes aluminium

Colours / Цветовая гамма



RAL 9016

white
белый
blanc
weiß



RAL 9017

brown
коричневый
brun
braun



RAL 5005

blue
синий
bleu
blau



RAL 1015

beige
бежевый
beige
beige



RAL 7001

grey
серый
gris
grau



RAL 9005

black
черный
noir
schwarz



- specially designed for combined extract and input ventilation
- для приточно-вытяжной вентиляции
- pour ventilation par refoulement et extraction
- für die zufuhr und abfuhrlüftung



- specially designed both for internal and external mounting
- для внутреннего и наружного монтажа
- installation intérieure et extérieure
- für innere und äußere montage



- screw fastening
- крепление при помощи шурупов
- fixation à l'aide de vis
- befestigung mit hilfe der verschraubungen



- weather resistant
- устойчива к атмосферным воздействиям
- stable à influence atmosphérique
- zu den atmosphärischen einwirkungen standfest



- anti-mosquito screen (upon request)
- защитная сетка от насекомых (по требованию)
- toile moustiquaire (à la demande)
- antiinsektennetz (nach forderung)



- metal (steel, aluminum)
- металл (сталь, алюминий)
- métal (acier, aluminium)
- metall (stahl, aluminium)

		Туре	Тип	L	H	l	h	air pass, cm ²	
MVMPO 300*75	МВМП 300*75	300	75	286	61	41	25		
MVMPO 305*90	МВМП 305*90	305	90	291	76	54	25		
MVMPO 370*40	МВМП 370*40	370	43	352	22	27	25		

		Туре	Тип	L	H	l	h	air pass, cm ²	
MVMPO 380*40	МВМП 380*40	380	43	366	29	54	25		
MVMPO 400*80	МВМП 400*80	400	80	386	66	72	25		

		Туре	Тип	L	H	l	h	air pass, cm ²	
MVMPO 500*40	МВМП 500*40	500	40	488	22	45	25		
MVMPO 500*60	МВМП 500*60	500	60	486	46	45	25		
MVMPO 500*90	МВМП 500*90	500	90	486	76	90	25		







		Туре	Тип	L	H	l	h	air pass, cm ²	
MVMPO 650*60	МВМП 650*60	650	60	636	46	63	25		
MVMPO 650*65	МВМП 650*65	650	65	632	47	81	25		



Colours / Цветовая гамма



	white белый blanc weiß		brown коричневый brun braun		blue синий bleu blau		beige бежевый beige beige		grey серый gris grau		black черный noir schwarz
RAL 9016		RAL 9017		RAL 5005		RAL 1015		RAL 7001		RAL 9005	

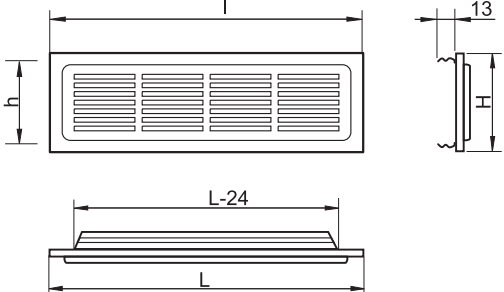

METAL GRILLES (DOOR) РЕШЕТКИ МЕТАЛЛИЧЕСКИЕ (ДВЕРНЫЕ)

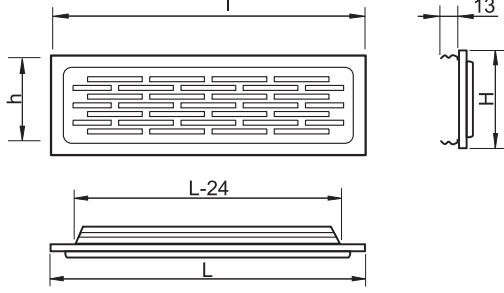

-  • specially designed for combined extract and input ventilation
• для приточно-вытяжной вентиляции
• pour ventilation par refoulement et extraction
• für die zuluft und abfuhrleitung
-  • specially designed for internal mounting
• для внутреннего монтажа
• installation intérieure
• für innere montage
-  • clips fastening
• крепление при помощи крепежных элементов
• fixation à l'aide de élément d'assemblage
• befestigung mit hilfe der befestigungselemente
-  • weather resistant
• устойчива к атмосферным воздействиям
• stable à influence atmosphérique
• zu den atmosphärischen einwirkungen standfest
-  • anti-mosquito screen (upon request)
• защитная сетка от насекомых (по требованию)
• toile moustiquaire (à la demande)
• antiinsektennetz (nach forderung)
-  • metal (steel)
• металл (сталь)
• métal (acier)
• metall (stahl)
-  • supply with fastening bracket
• оборудована крепежным кронштейном
• outiller avec support de fixation
• ausgestattet mit der festigungskonsolle

		Type	Тип	L	H	l	h	air pass, cm ²	
MVM 250*80 K1	MBM 250*80 K1	252,5	80	240,5	68	55	25		
MVM 475*80 K1	MBM 475*80 K1	475	80	468	68	110	25		

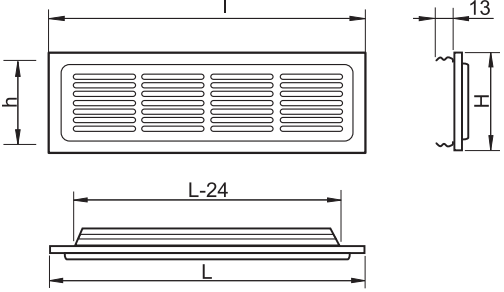
		Type	Тип	L	H	l	h	air pass, cm ²	
MVM 250*80 K2	MBM 250*80 K2	252,5	80	240,5	68	53	25		
MVM 475*80 K2	MBM 475*80 K2	475	80	468	68	102	25		

		Type	Тип	L	H	l	h	air pass, cm ²	
MVM 250*80 K3	MBM 250*80 K3	252,5	80	240,5	68	52	25		
MVM 475*80 K3	MBM 475*80 K3	475	80	468	68	103	25		

Material / Исполнение

 steel painted
сталь окрашенная
acier coloré
stahl gefärbtes

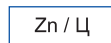
 Zn / Ц galvanized steel
сталь оцинкованная
acier galvanisé
verzinkter stahl

Colours / Цветовая гамма

 white RAL 9016	 brown RAL 9017	 blue RAL 5005	 beige RAL 1015	 grey RAL 7001	 black RAL 9005
white белый blanc weiß	brown коричневый brun braun	blue синий bleu blau	beige бежевый beige beige	grey серый gris grau	black черный noir schwarz

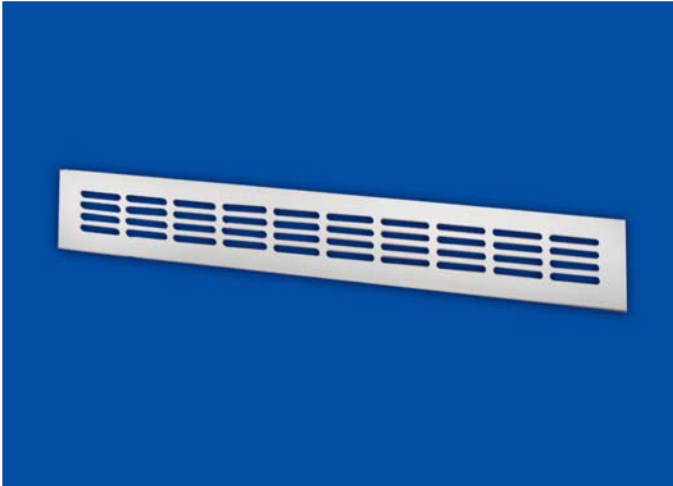

- specially designed for combined extract and input ventilation
- для приточно-вытяжной вентиляции
- pour ventilation par refolement et extraction
- für die zuluft und abfuhrlüftung



- specially designed for internal mounting
- для внутреннего монтажа
- installation intérieure
- für innere montage



- clips fastening
- крепление при помощи крепежных элементов
- fixation à l'aide de élément d'assemblage
- befestigung mit hilfe der befestigungselemente



- anti-mosquito screen (upon request)
- защитная сетка от насекомых (по требованию)
- toile moustiquaire (à la demande)
- antiinsektennetz (nach forderung)



- metal (aluminum)
- металл (алюминий)
- métal (aluminium)
- metall (aluminium)

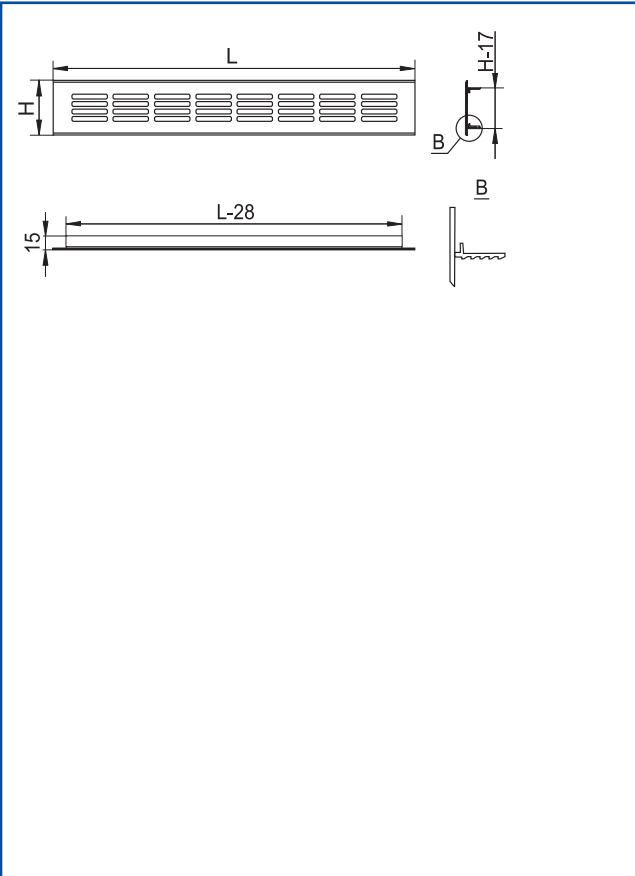

Тип	Тип	L	H	air pass, cm ²	
MVMA 400*60	МВМА 400*60	400	60	62	25
MVMA 400*80	МВМА 400*80	400	80	93	25
MVMA 400*100	МВМА 400*100	400	100	120	25
MVMA 500*60	МВМА 500*60	500	60	78	25
MVMA 500*80	МВМА 500*80	500	80	120	25
MVMA 500*100	МВМА 500*100	500	100	156	25
MVMA 600*60	МВМА 600*60	600	60	93	25
MVMA 600*80	МВМА 600*80	600	80	140	25
MVMA 600*100	МВМА 600*100	600	100	186	25
MVMA 800*60	МВМА 800*60	800	60	120	25
MVMA 800*80	МВМА 800*80	800	80	186	25
MVMA 800*100	МВМА 800*100	800	100	248	25
MVMA 1000*60	МВМА 1000*60	1000	60	160	25
MVMA 1000*80	МВМА 1000*80	1000	80	256	25
MVMA 1000*100	МВМА 1000*100	1000	100	326	25

Material / Исполнение

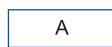

aluminium
алюминий
aluminium
aluminium



aluminium painted
алюминий окрашенный
aluminium coloré
gefärbtes aluminium

Colours / Цветовая гамма



white
белый
blanc
weiß

RAL 9016



brown
коричневый
brun
braun

RAL 9017



blue
синий
bleu
blau

RAL 5005



beige
бежевый
beige
beige

RAL 1015



grey
серый
gris
grau

RAL 7001







black
черный
noir
schwarz

RAL 9005

METAL GRILLES (ADJUSTABLE) РЕШЕТКИ МЕТАЛЛИЧЕСКИЕ (РЕГУЛИРУЕМЫЕ)



- 
 - specially designed for combined extract and input ventilation
 - для приточно-вытяжной вентиляции
 - pour ventilation par refoulement et extraction
 - für die zufuhr und abfuhrleitung
- 
 - specially designed for internal mounting
 - для внутреннего монтажа
 - installation intérieure
 - für innere montage
- 
 - screw fastening
 - крепление при помощи шурупов
 - fixation à l'aide de vis
 - befestigung mit hilfe der verschraubungen
- 
 - metal (aluminum)
 - металл (алюминий)
 - métal (aluminium)
 - metall (aluminium)
- 
 - manual adjustment of effective cross-section
 - ручная регулировка живого сечения
 - manuel réglage de l'aire de grille
 - manuelles regulieren des querschnittes

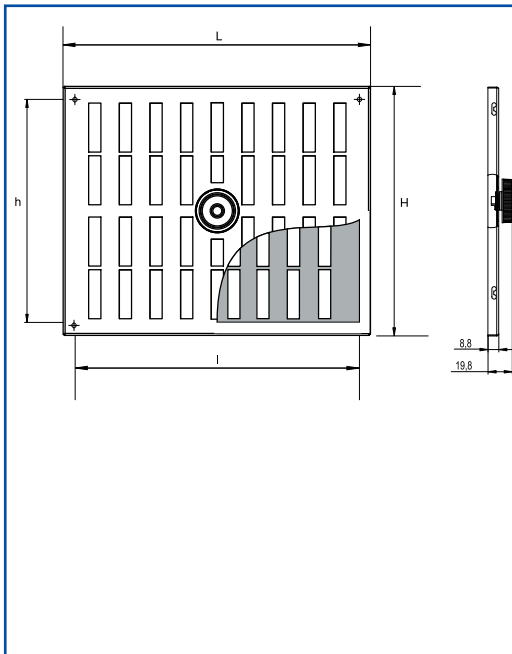

Type	Тип	L	H	l	h	air pass, cm ²	
MVMPO 155 RA	МВМПО 155 РА	155	155	132	132	47	25
MVMPO 150*200 RA	МВМПО 150*200 РА	150	200	132	182	67	25
MVMPO 160 RA	МВМПО 160 РА	160	160	137	137	51	25
MVMPO 200*150 RA	МВМПО 200*150 РА	200	150	182	132	61	25
MVMPO 200 RA	МВМПО 200 РА	200	200	182	182	99	25
MVMPO 200*250 RA	МВМПО 200*250 РА	200	250	182	232	135	25
MVMPO 200*300 RA	МВМПО 200*300 РА	200	300	182	282	162	25
MVMPO 250*200 RA	МВМПО 250*200 РА	250	200	232	182	108	25
MVMPO 250*300 RA	МВМПО 250*300 РА	250	300	232	282	171	25
MVMPO 300*200 RA	МВМПО 300*200 РА	300	200	282	182	172	25
MVMPO 300*250 RA	МВМПО 300*250 РА	300	250	282	232	204	25

Material / Исполнение

A aluminium
алюминий
aluminium
aluminium

A aluminium painted
алюминий окрашенный
aluminium coloré
gefärbtes aluminium

Colours / Цветовая гамма

white
белый
blanc
weiß

brown
коричневый
brun
braun





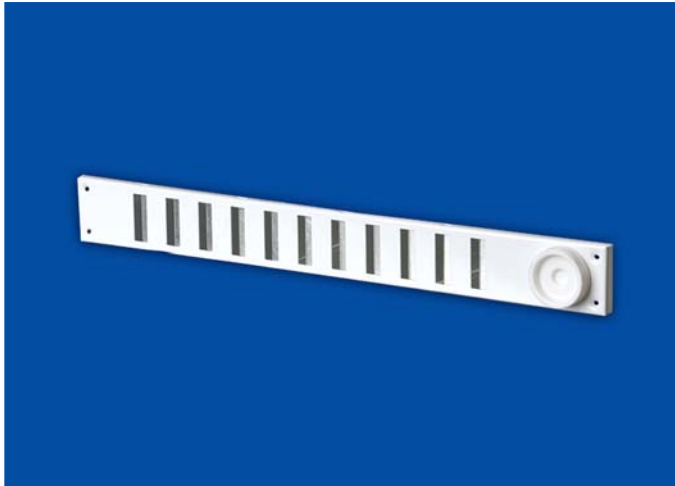

blue
синий
bleu
blau

beige
бежевый
beige
beige

grey
серый
gris
grau

black
черный
noir
schwarz



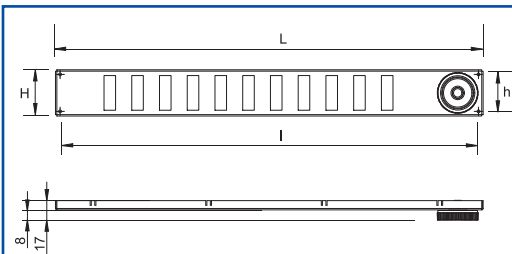

-  • specially designed for combined extract and input ventilation
• для приточно-вытяжной вентиляции
• pour ventilation par refoulement et extraction
• für die zuluft und abfuhrleitung
-  • specially designed for internal mounting
• для внутреннего монтажа
• installation intérieure
• für innere montage
-  • screw fastening
• крепление при помощи шурупов
• fixation à l'aide de vis
• befestigung mit hilfe der verschraubungen
-  • anti-mosquito screen (upon request)
• защитная сетка от насекомых (по требованию)
• toile moustiquaire (à la demande)
• antiinsektennetz (nach forderung)
-  • metal (aluminum)
• металл (алюминий)
• métal (aluminium)
• metall (aluminium)
-  • manual adjustment of effective cross-section
• ручная регулировка живого сечения
• manuel réglage de l'aire de grille
• manuelles regulieren des querschnittes









Туре	Тип	L	H	l	h	air pass, cm ²	
MVMPO 370*40 RA	МВМПО 370*40 РА	370	40	356	29	13	25
MVMPO 495*65 RA	МВМПО 495*65 РА	495	65	477	47	72	25
MVMPO 500*40 RA	МВМПО 500*40 РА	500	40	482	29	54	25
MVMPO 500*90 RA	МВМПО 500*90 РА	500	90	482	72	90	25
MVMPO 650*60 RA	МВМПО 650*60 РА	650	60	632	42	63	25
MVMPO 650*65 RA	МВМПО 650*65 РА	650	65	632	44	110	25

Material / Исполнение

 aluminium
алюминий
aluminium
aluminium





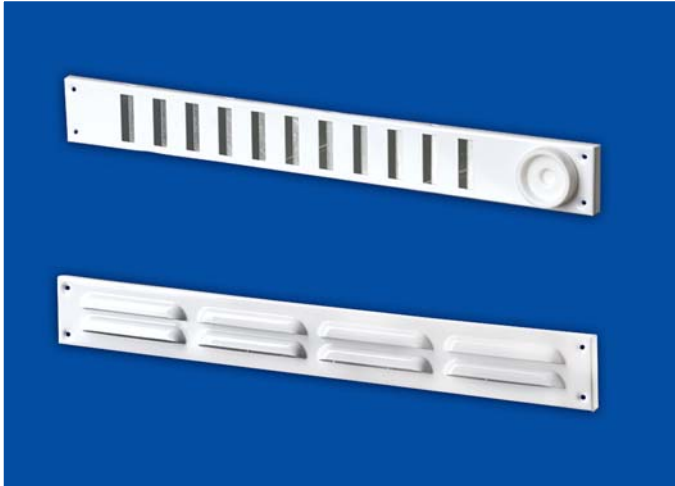

 aluminium painted
алюминий окрашенный
aluminium coloré
gefärbtes aluminium

Colours / Цветовая гамма

 white белый blanc weiß	 brown коричневый brun braun	 blue синий bleu blau	 beige бежевый beige beige	 grey серый gris grau	 black черный noir schwarz
RAL 9016	RAL 9017	RAL 5005	RAL 1015	RAL 7001	RAL 9005

METAL GRILLES (DOUBLE) РЕШЕТКИ МЕТАЛЛИЧЕСКИЕ (ДВОЙНЫЕ)



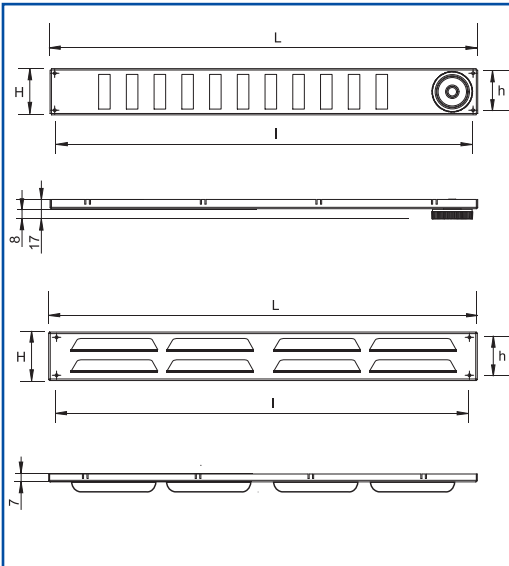

-  • specially designed for combined extract and input ventilation
• для приточно-вытяжной вентиляции
• pour ventilation par refoulement et extraction
• für die zufuhr und abfuhrleitung
-  • specially designed for internal mounting
• для внутреннего монтажа
• installation intérieure
• für innere montage
-  • screw fastening
• крепление при помощи шурупов
• fixation à l'aide de vis
• befestigung mit hilfe der verschraubungen
-  • anti-mosquito screen (upon request)
• защитная сетка от насекомых (по требованию)
• toile moustiquaire (à la demande)
• antiinsektennetz (nach forderung)
-  • metal (aluminum)
• металл (алюминий)
• métal (aluminium)
• metall (aluminium)
-  • manual adjustment of effective cross-section
• ручная регулировка живого сечения
• manuel réglage de l'aire de grille
• manuelles regulieren des querschnittes







Тype	Тип	L	H	l	h	air pass, cm ²	
MVMPO 370*40 RB	МВМПО 370*40 РБ	370	40	356	29	33	25
MVMPO 500*40 RB	МВМПО 500*40 РБ	500	40	386	29	42	25
MVMPO 650*65 RB	МВМПО 650*65 РБ	650	65	636	44	60	25

Material / Исполнение





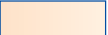
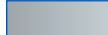

 aluminium
алюминий
aluminium
aluminium

 aluminium painted
алюминий окрашенный
aluminium coloré
gefärbtes aluminium

Colours / Цветовая гамма

	white белый blanc weiß		brown коричневый brun braun		blue синий bleu blau		beige бежевый beige beige		grey серый gris grau		black черный noir schwarz
RAL 9016		RAL 9017		RAL 5005		RAL 1015		RAL 7001		RAL 9005	



-  • specially designed for combined extract and input ventilation
- для приточно-вытяжной вентиляции
- pour ventilation par refoulement et extraction
- für die zufuhr und abfuhrlüftung
-  • specially designed for internal mounting
- для внутреннего монтажа
- installation intérieure
- für innere montage
-  • screw fastening
- крепление при помощи шурупов
- fixation à l'aide de vis
- befestigung mit hilfe der verschraubungen
-  • anti-mosquito screen (upon request)
- защитная сетка от насекомых (по требованию)
- toile moustiquaire (à la demande)
- antiinsektennetz (nach forderung)
-  • metal (aluminum)
- металл (алюминий)
- métal (aluminium)
- metall (aluminium)
-  • manual adjustment of effective cross-section
- ручная регулировка живого сечения
- manuel réglage de l'aire de grille
- manuelles regulieren des querschnittes





		Типе	Тип	L	H	l	h	air pass, cm ²	
		MVMPO 380*40 RD	МВМПО 380*40 РД	380	43	366	29	35	25

Material / Исполнение

A  aluminium
алюминий
aluminium
aluminium

A  aluminium painted
алюминий окрашенный
aluminium coloré
gefärbtes aluminium

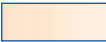
Colours / Цветовая гамма

 white белый blanc weiß	 brown коричневый brun braun	 blue синий bleu blau	 beige бежевый beige beige	 grey серый gris grau	 black черный noir schwarz
RAL 9016	RAL 9017	RAL 5005	RAL 1015	RAL 7001	RAL 9005

Material / Исполнение



steel painted
сталь окрашенная
acier coloré
stahl gefärbtes

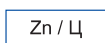

galvanized steel
сталь оцинкованная
acier galvanisé
verzinkter stahl



aluminium
алюминий
aluminium
aluminium



aluminium painted
алюминий окрашенный
aluminium coloré
gefärbtes aluminium

Anti-mosquito screen / Антимоскитная сетка



without anti-mosquito screen
без защитной сетки от насекомых
sans toile moustiquaire
ohne antiinsektennetz

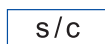

anti-mosquito screen
защитная сетка от насекомых
toile moustiquaire
antiinsektennetz

Colours / Цветовая гамма *



white
белый
blanc
RAL 9016
weiß



brown
коричневый
brun
RAL 9017
braun



blue
синий
bleu
RAL 5005
blau



beige
бежевый
beige
RAL 1015
beige



grey
серый
gris
RAL 7001
grau



black
черный
noir
RAL 9005
schwarz

* Possible painting in any colour by RAL / Возможность окраски в любой цвет по RAL

Decor design / Декоративное исполнение *

Туре/Тип 2

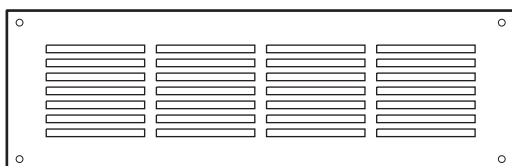

Туре/Тип 3

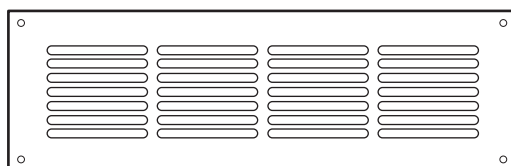

Туре/Тип 4

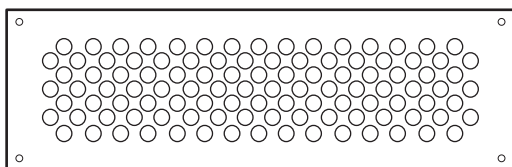

Туре/Тип 5

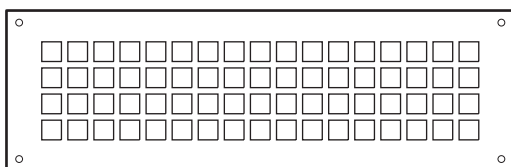

Туре/Тип 6

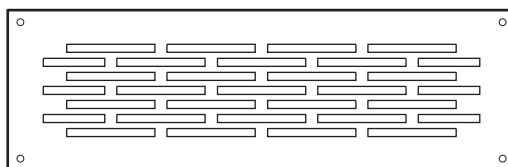

* Upon request / По индивидуальному запросу



Сдано в производство 15.02.2008. Подписано к печати 18.02.2008.

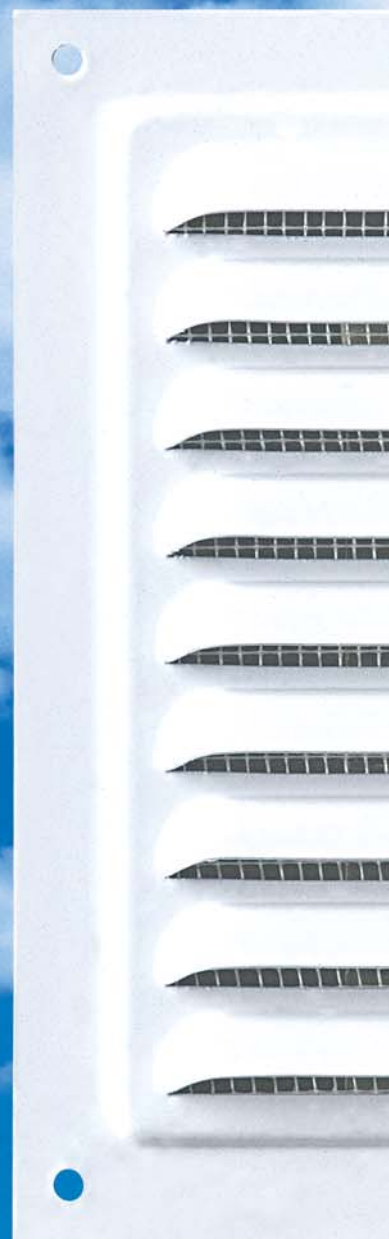

VENTS reserves the rights to modify products for whatever constructive or commercial reason whenever necessary and without warning

ВЕНТС оставляет за собой право вносить любые изменения, вызванные необходимостью производства, без уведомления

English/Русский

10/07