

Series
VENTS KSB



Inline centrifugal fans in heat- and sound-insulated casing with air flow up to **2150 m³/h**

■ **Applications**

KSB fan design enables its application in supply and exhaust ventilation systems for commercial, office and other public or industrial premises with high requirements to noise level and limited mounting space. Provision is made for installation in a premise above the suspended ceiling. Suitable for connection with 100, 125, 150, 160, 200, 250 and 315 mm round ducts.

■ **Design**

The fan casing is made of galvanized steel sheet and provided with heat- and sound-insulating material. Round connecting pipes are fitted with rubber seals.

■ **Motor**

The centrifugal impeller with backward curved blades is powered by means of 2-pole asynchronous motor with external rotor. The motors are equipped with built-in thermal overheating protection with automatic restart. Motor ball bearings with selective lubricating oil ensure low-noise and maintenance-free fan operation. The motor is installed onto the rubber anti-vibration mounts to reduce vibration and noise. Models marked KSB...S are featured with the high-powered motors.

■ **Speed control**

Smooth or step speed control with a thyristor or autotransformer speed controller. Several fans may be connected to one speed controller provided that the total power and operating current do not exceed the rated speed controller parameters.

■ **Mounting**

The fans are designed for inline mounting inside an air duct of matching air duct diameter, in any point of the ventilation system and at any angle. The fan shall be fixed to a building by means of supports, suspension brackets or fixation brackets in case of flexible connectors application. The fan can be mounted in any position with respect to the air flow direction indicated with a pointer on the fan casing. Access to the fan maintenance shall be provided.

■ **The fan with electronic temperature and control module (U option).**

The ideal solution for ventilation of the premises requiring permanent temperature control, i.e. greenhouses. The fan with the electronic temperature and speed control module provides automatic control of the motor speed (air flow) depending on air temperature in the air duct or in the room.

The front panel of the electronic module has the following control knobs:

- speed control knob for setting the motor speed;
- thermostat control knob for setting the temperature set point;
- thermostat indicator light.

The fan is available in two modifications:

- with the temperature sensor integrated inside the fan air duct (U/U1 option);
- with the external temperature sensor fixed on the cable, 4 m long (Un/U1n/U2n).

Designation key

Series	Spigot diameter	Options
VENTS KSB	100; 125; 150; 160; 200; 250; 315	<p>S: high-powered motor</p> <p>U: speed controller with an electronic thermostat and a temperature sensor integrated inside an air duct. Temperature-based operation logic.</p> <p>Un: speed controller with an electronic thermostat and a temperature sensor fixed on a 4-meter cable. Temperature-based operation logic.</p> <p>U1: speed controller with an electronic thermostat and a temperature sensor integrated inside an air duct. Timer-based operation logic.</p> <p>U1n: speed controller with an electronic thermostat and a temperature sensor fixed on a 4-meter cable. Timer-based operation logic.</p> <p>U2n: speed controller with an electronic thermostat and a temperature sensor fixed on a 4-meter cable. Temperature-based switching on/off.</p> <p>R1: power cord with a mains plug.</p> <p>P: integrated smooth speed controller.</p>

Accessories



Silencer

Filters

Heaters

Backdraft damper

Air shutter

Speed controllers

Sensor

Control logic of the fan with the electronic temperature and speed control module.

Set the desired air temperature (thermostat set point) by turning the thermostat control knob. Set the required minimum impeller speed (air flow) by turning the speed control knob. The motor switches to maximum speed (maximum air flow) as the temperature reaches and exceeds the set temperature set point. The motor switches to the pre-set lower speed as the temperature drops down below the temperature set point. To avoid frequent motor speed switches when the air temperature in the duct is equal to the set temperature point, the speed switch delay is activated. There are three switch delay patterns for various cases:

1. The temperature sensor-based switch delay (U option): the motor switches to higher speed as the air temperature exceeds 2 °C above the set thermostat set

point. The motor reverts to the preset lower speed as the air temperature drops below the thermostat set point. This pattern is used to keep air temperature to within 2 °C. In this case the motor speed switches are rare.

2. The timer-based switch delay (U1 option): as the air temperature exceeds the set thermostat set point, the motor switches to higher speed and the switch delay timer is activated for 5 min. The motor reverts to lower speed as the air temperature drops down below the thermostat set point and only after 5 minutes timer countdown. This pattern is used for exact air temperature control. The speed switches for the fan with U1 option are more frequent as compared to the operating logic of the fan with U option, however the minimum operating cycle at one speed is 5 minutes.

3. Switching ON/OFF by a temperature sensor (U2 option): when the air temperature exceeds by

2 °C the thermostat actuation set point, the fan starts operating at the set speed. The fan switches off when the temperature drops below the temperature set point.

Example for temperature sensor delay:

Initial conditions:

- rated speed is set as 60 % of the maximum speed
- operating threshold is set as 25 °C
- air temperature in the duct is 20 °C

Fan operates with the rated speed =60 %

• air temperature in the duct rises
fan operates with the rated speed =60 %

• air temperature in the duct reaches 27 °C
Fan switches to the speed =100 %

• air temperature in the duct goes down
fan operates with the speed =100 %

• temperature in the duct reaches 25 °C again
fan switches to the preset rated speed =60 %

Example for timer delay:

Initial conditions:

- set rotation speed = 60 % of maximum speed
- set operating threshold =25 °C
- air temperature in the duct =20 °C

motor operates with the motor speed =60 %

• the temperature in the duct rises, reaches 25 °C and keeps rising

fan switches to the maximum speed =100 % and the delay timer switches for 5 minutes on

• the temperature in the duct goes down
the fan operates with the maximum speed =100 %

• the temperature in the duct reaches 25 °C and keeps going down

after the timer stops, the motor switches to the preset rated speed (=60 %). After the speed switch the timer switches again for 5 minutes on.

• the temperature in the duct rises, reaches 25 °C and keeps rising

after the timer stops, the motor switches to the maximum speed (=100 %). After the speed switch the timer switches again for 5 minutes on.

Thus, in timer delay pattern the delay timer activates every time the fan speed changes.

Fan overall dimensions

Type	Dimensions [mm]							Mass [kg]
	∅D	B	B1	H	L	L1	L2	
KSB 100	99	322	280	192	447	380	350	5.4
KSB 125	124	322	280	192	447	380	350	5.4
KSB 150	149	352	310	212	477	410	380	6.4
KSB 160	159	352	310	212	477	410	380	6.4
KSB 200	199	432	368	287	588	506	480	10.0
KSB 200 S	199	432	368	287	588	506	480	12.0
KSB 250	249	432	368	287	588	506	480	12.5
KSB 315	314	502	438	397	648	566	540	15.5

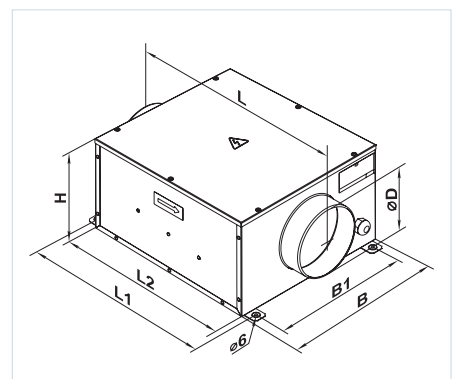

SOUND-INSULATED FANS

Technical data

	KSB 100		KSB 125		KSB 150		KSB 160	
Voltage [V]	1~230		1~230		1~230		1~230	
Frequency [Hz]	50	60	50	60	50	60	50	60
Power [W]	73	77	73	77	72	76	75	76
Current [A]	0.32	0.34	0.32	0.34	0.32	0.33	0.33	0.33
Max. air flow [m³/h]	240	255	330	345	420	435	420	435
RPM [min ⁻¹]	2560	2690	2590	2700	2600	2720	2690	2720
Noise level at 3 m [dBA]	33	34	35	36	36	37	36	37
Transported air temperature [°C]	-25...+55		-25...+55		-25...+55		-25...+55	
SEC class	C		C		C		C	
Protection rating	IPX4		IPX4		IPX4		IPX4	

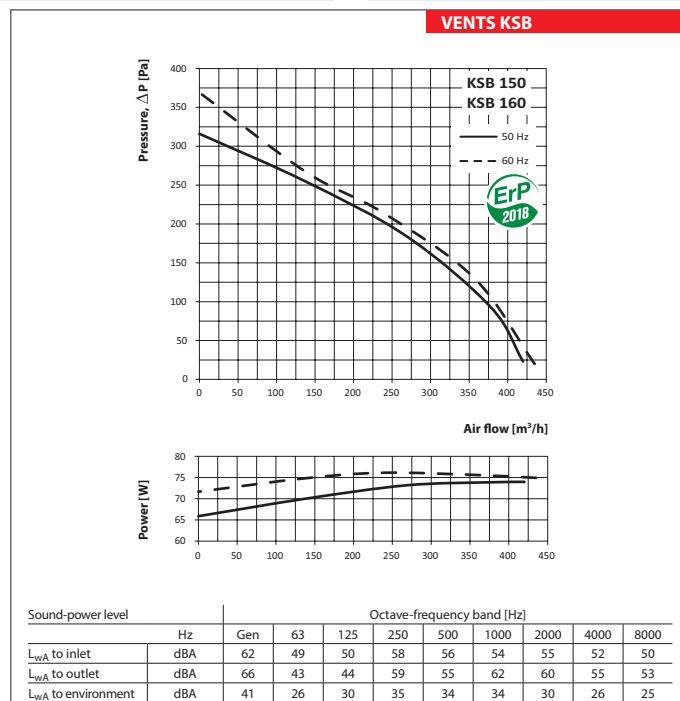
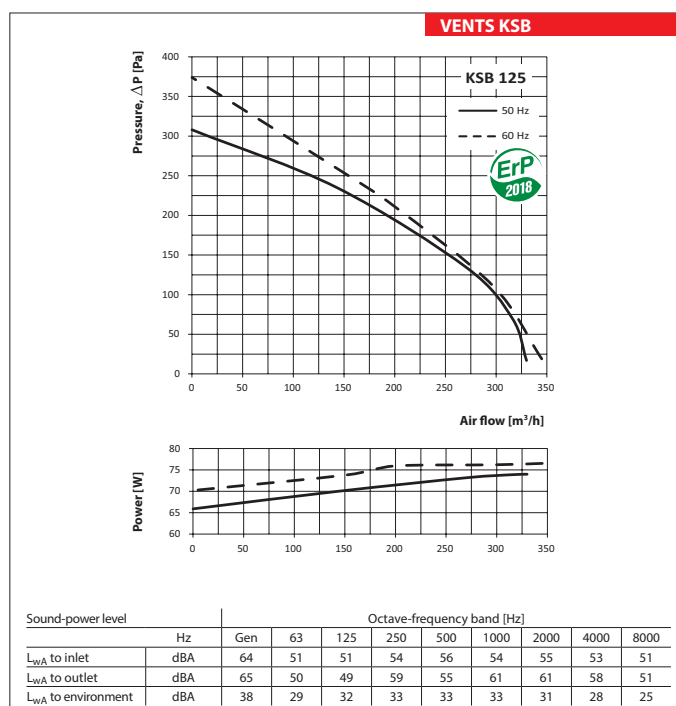
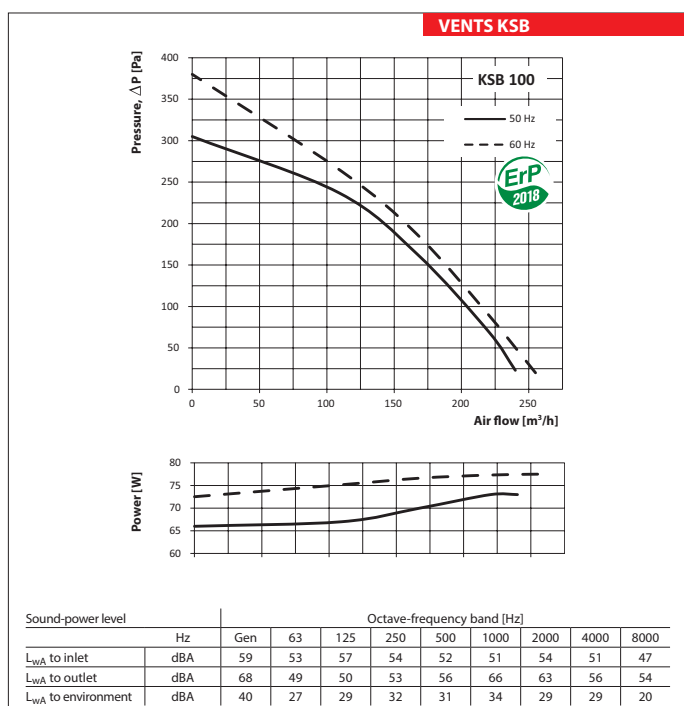

Technical data

	KSB 200		KSB 200 S		KSB 250		KSB 315	
Voltage [V]	1~230		1~230		1~230		1~230	
Frequency [Hz]	50	60	50	60	50	60	50	60
Power [W]	103	122	195	232	198	238	322	367
Current [A]	0.45	0.53	0.85	1,02	0.87	1,04	1.4	1.6
Max. air flow [m ³ /h]	730	750	950	960	1300	1315	2150	2150
RPM [min ⁻¹]	2550	2740	2570	2690	2420	2730	2670	2850
Noise level at 3 m [dBA]	38	39	41	42	41	43	43	44
Transported air temperature [°C]	-25...+55		-25...+55		-25...+55		-25...+55	
SEC class	B		B		-		-	
Protection rating	IPX4		IPX4		IPX4		IPX4	

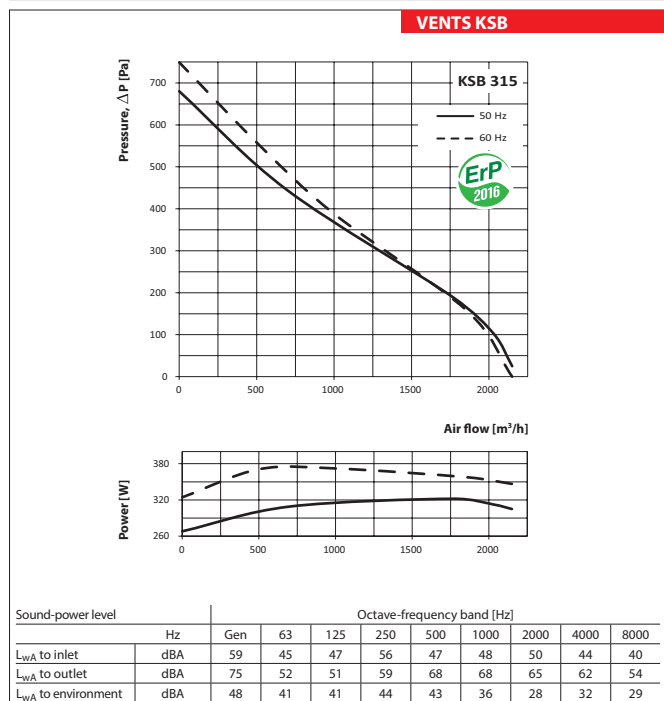
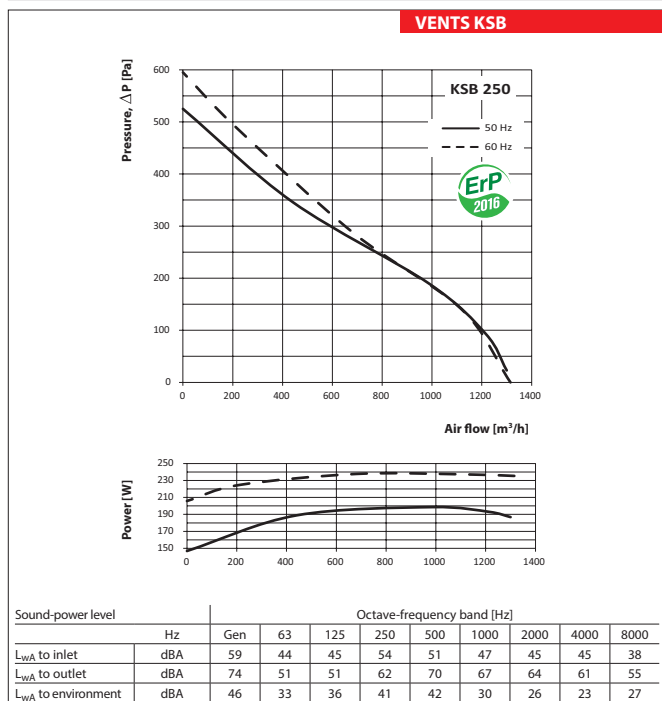
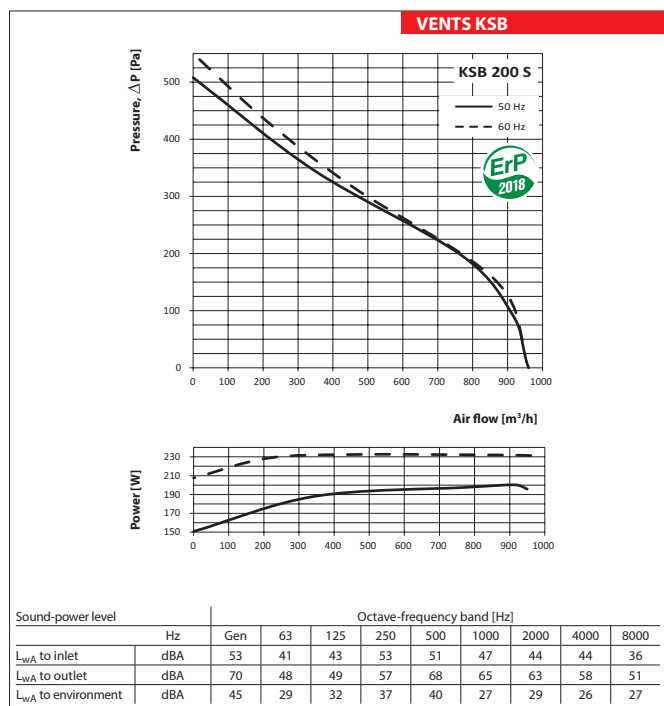
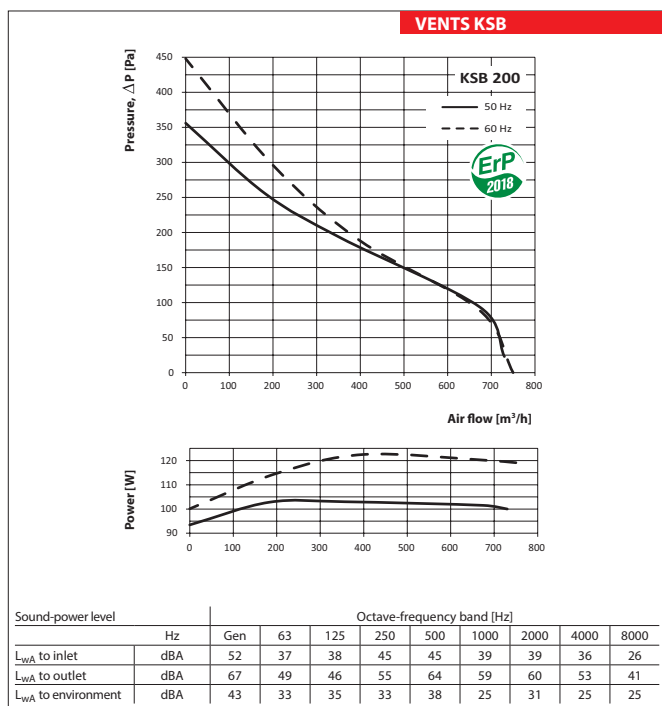

FAN SERIES VENTS KSB