

USER'S MANUAL

pGD1(A17)
th-Tune (A18)

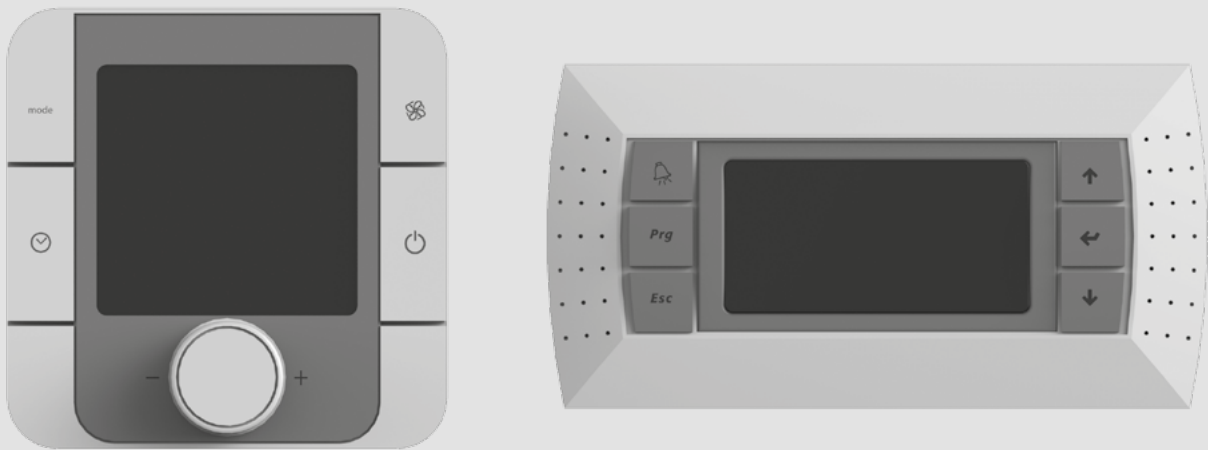

Automatic control system for air handling units

CONTENTS

Safety requirements.....	3
Purpose.....	4
Technical data.....	4
Installation and set-up.....	5
Control	7

This user's manual is a main operating document intended for technical, maintenance, and operating staff.

The manual contains information about purpose, technical details, operating principle, design, and installation of the th-Tune (A17)/pGD1 (A18) unit and all its modifications.

Technical and maintenance staff must have theoretical and practical training in the field of ventilation systems and should be able to work in accordance with workplace safety rules as well as construction norms and standards applicable in the territory of the country.

The information in this user's manual is correct at the time of the document's preparation.

The Company reserves the right to modify the technical characteristics, design, or configuration of its products at any time in order to incorporate the latest technological developments.

No part of this publication may be reproduced, stored in a retrieval system, or transmitted, in any form or by any means in any information search system or translated into any language in any form without the prior written permission of the Company.

SAFETY REQUIREMENTS

- Please read the user's manual carefully prior to installing and operating the unit.
- All user's manual requirements as well as the provisions of all the applicable local and national construction, electrical, and technical norms and standards must be observed when installing and operating the unit.
- The warnings contained in the user's manual must be considered most seriously since they contain vital personal safety information.
- Failure to follow the rules and safety precautions noted in this user's manual may result in an injury or unit damage.
- After a careful reading of the manual, keep it for the entire service life of the unit.
- While transferring the unit control, the user's manual must be turned over to the receiving operator.

UNIT MOUNTING AND OPERATION SAFETY PRECAUTIONS

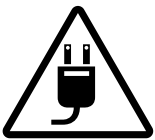

- Disconnect the unit from power mains prior to any installation operations.



- Do not operate the unit outside the temperature range stated in the user's manual.
- Do not operate the unit in aggressive or explosive environments.



- Do not lay the power cable of the unit in close proximity to heating equipment.



- While installing the unit follow the safety regulations specific to the use of electric tools.



- Do not change the power cable length at your own discretion.
- Do not bend the power cable.
- Avoid damaging the power cable.
- Do not put any foreign objects on the power cable.



- Unpack the unit with care.

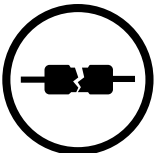

- Do not use damaged equipment or cables when connecting the unit to power mains.



- When the unit generates unusual sounds, odour or emits smoke disconnect it from power supply and contact the Seller.



- Do not touch the unit controls with wet hands.
- Do not carry out the installation and maintenance operations with wet hands.

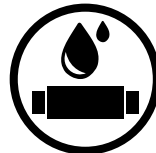

- Do not wash the unit with water.
- Protect the electric parts of the unit against ingress of water.



- Do not allow children to operate the unit.



- Disconnect the unit from power mains prior to any technical maintenance.



**THE PRODUCT MUST BE DISPOSED SEPARATELY AT THE END OF ITS SERVICE LIFE.
DO NOT DISPOSE THE UNIT AS UNSORTED MUNICIPAL WASTE.**

PURPOSE

The control panel is designed for controlling industrial and domestic supply and exhaust ventilation units as well as other air handling units. It is rated for continuous operation.



THE UNIT SHOULD NOT BE OPERATED BY CHILDREN OR PERSONS WITH REDUCED PHYSICAL, MENTAL, OR SENSORY CAPACITIES, OR THOSE WITHOUT THE APPROPRIATE TRAINING. THE UNIT MUST BE INSTALLED AND CONNECTED ONLY BY PROPERLY QUALIFIED PERSONNEL AFTER THE APPROPRIATE BRIEFING. THE CHOICE OF UNIT INSTALLATION LOCATION MUST PREVENT UNAUTHORIZED ACCESS BY UNATTENDED CHILDREN.

TECHNICAL DATA

Parameter	Value	
	th-Tune (A17)	pGD1 (A18)
Storage temperature [°C]	from -20 to +70	from -20 to +70
Storage humidity [%]	from 10 to 90 (no condensation)	from 10 to 90 (no condensation)
Operation temperature [°C]	from -10 to +60	from -20 to +60
Operation humidity [%]	from 10 to 90 (no condensation)	from 10 to 90 (no condensation)
Wire	AWG 20 or AWG 22 up to 500 m	phone cable up to 50 m twister pair AWG 22 up to 500 m
Ingress protection	IP20	IP65 if mounted on the panel IP40 if mounted on the wall

OVERALL DIMENSIONS OF A17 CONTROL PANEL

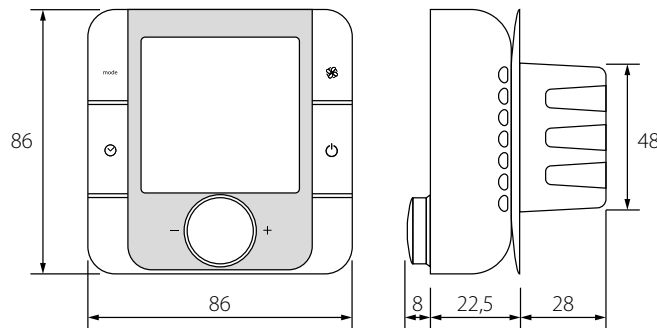

OVERALL DIMENSIONS OF A18 CONTROL PANEL

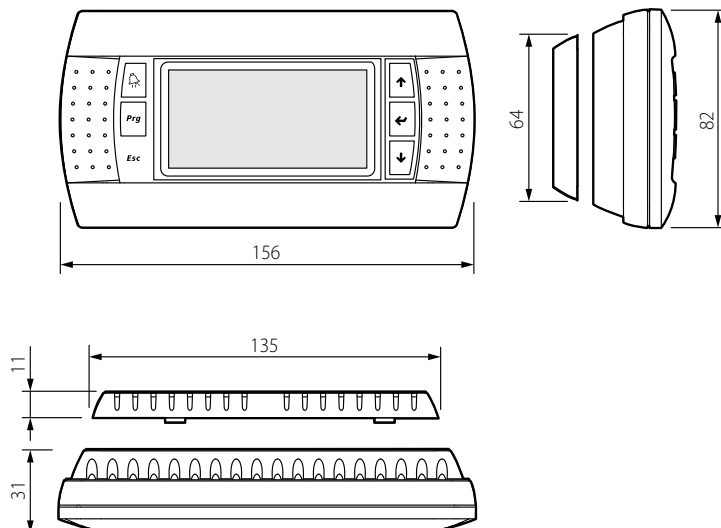

INSTALLATION AND SET-UP

TH-TUNE (A17) CONTROL PANEL INSTALLATION

To install the rear part of the control panel, use a suitable mounting box (minimum diameter 65 mm and minimum depth 31 mm).

1. Use a screwdriver to pull the front and the rear sides of the control panel apart.
2. Disconnect the 4-pin socket from the front part of the control panel.

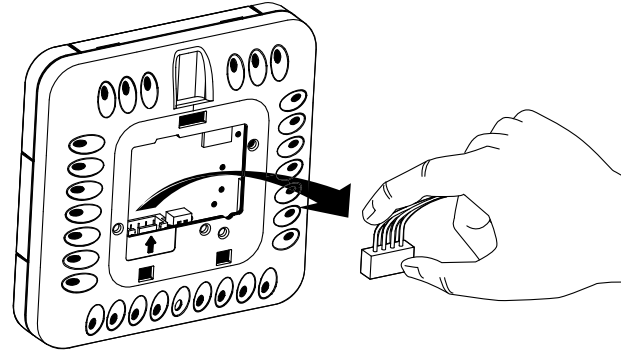
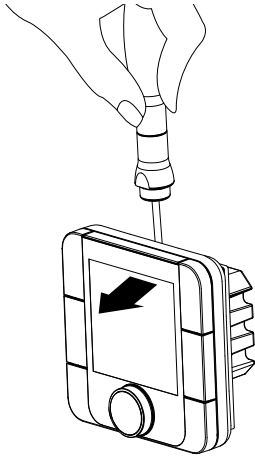

3. Complete the electrical connections as shown in the external wiring diagram.
4. Secure the rear part of the control panel in the mounting box using the screws supplied.
5. Reconnect the 4-pin socket.
6. Lay all the cables inside the control panel and install the control panel starting from the bottom. Make sure that none of the internal wires prevent closing with a click.

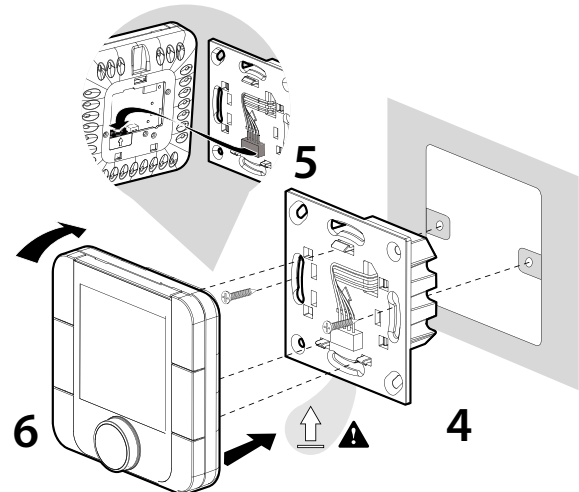
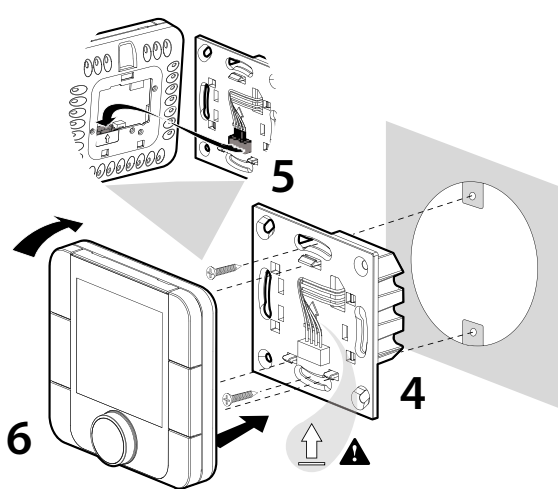

Overall dimensions of the control panel rear part [mm]

The outline drawing of the control panel rear part is on the left.

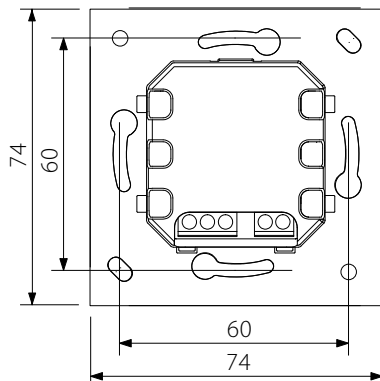

PGD1 (A18) CONTROL PANEL INSTALLATION

Connect the pGD1 control panel to the controller connector using the 6P6C (PLUG-6P6C-P-C2) phone plug. The maximum length of the phone cable is 50 m.

To mount the control panel on a wall, route the phone cable to the selected location.

1. Secure the rear part of the casing in the standard box by means of the round-head screws supplied.

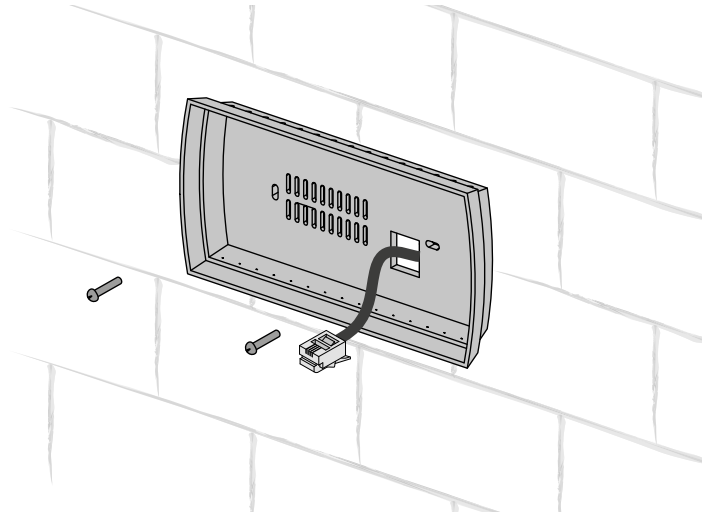

2. Connect the phone cable to the front part of the control panel. Fix the front part of the control panel to the rear part of the casing with countersunk screws supplied as shown in the figure below and then install the front bezel by pushing it until it clicks in position.

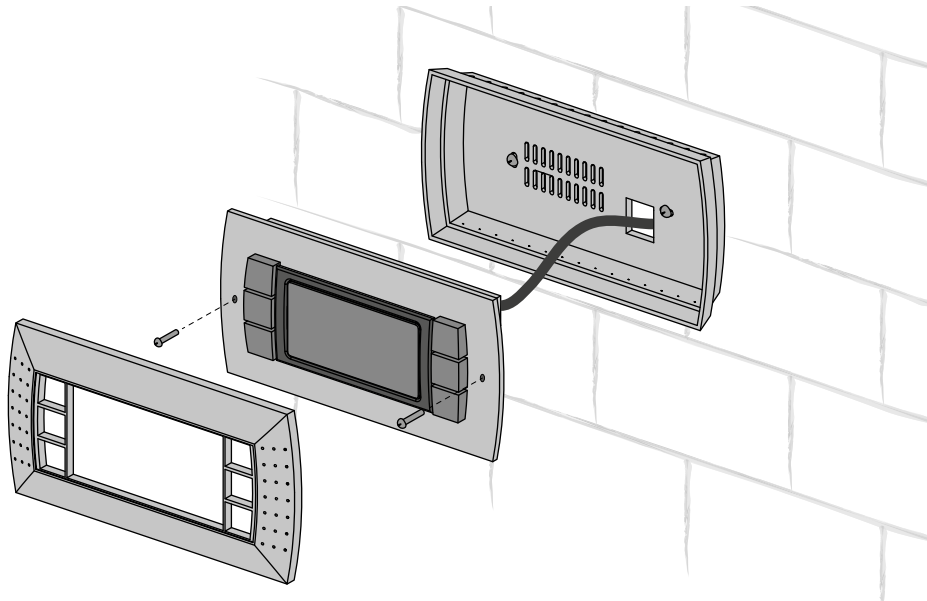



th-Tune

UNIT CONTROL PANELS

The unit is controlled via the th-Tune or pGD1 control panels.

BUTTON	FUNCTION
mode	Auto or manual speed control selection.
	Fan speed selection: setting required speed stage (off, low, medium, high).
	Scheduled operation on/off: short pressing. Activation is confirmed by a pictogram . Access to the time/time range setting menu: press and hold for 3 seconds. Use the rotary knob to choose the necessary option: setting the current date/time: starts blinking. Turn the knob for setup. TIMEBAND: setting the time range. Press to set the start time and the corresponding temperature setpoint for each time range individually (you may create up to four time ranges). The pictogram shows a current day status (Day/Nigh) and time range status depending on the presence or absence of people in the house. Press ESC to exit and return to the standard display mode. ESC: exit. After 10 seconds th-Tune returns to the main menu automatically.
	Unit ON/OFF. In some menus a short pressing has the same function as ESC.
	Setting a set point with a rotary knob.

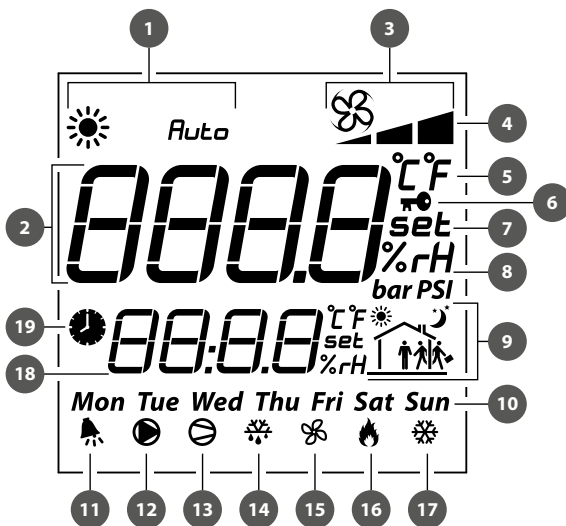
DISPLAY SYMBOLS

1.	Reheating operation mode: Auto : reheating in auto mode : reheating is enabled in manual mode
2.	Main field
3.	Fan mode: Manual/Auto
4.	Fan speed indicator
5.	Temperature measurement unit
6.	Lock function
7.	Setpoint value
8.	Humidity measurement unit
9.	Current time range
10.	Day of the week
11.	Alarm signal. An alarm reason is displayed in the controller
12.	Disabled
13.	Disabled
14.	Disabled
15.	Ventilation mode (reheating is not allowed)
16.	Electric heating elements operation enable signal
17.	Disabled
18.	Time
19.	Unit scheduled operation enabled

 Upon elapsing of the set time to filter replacement the display shows the alarm symbol and **FIL** in the auxiliary field.

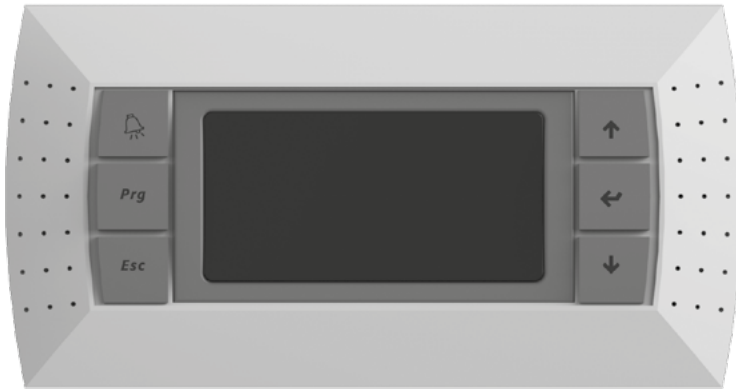

Connect the pGD1 control panel to the controller connector using the 6P6C (PLUG-6P6C-P-C2) phone plug. The maximum length of the phone cable is 50 m. Operation with the pGD1 control panel is identical with operation from the controller.

CONTROLLER FUNCTIONS AND MENU

The controller has the following control elements and indicators:

Backlit LCD display: the display screen shows the current parameters of the system operation, temperature values, pre-set parameters and alarms.

Buttons: intended for operating the controller.

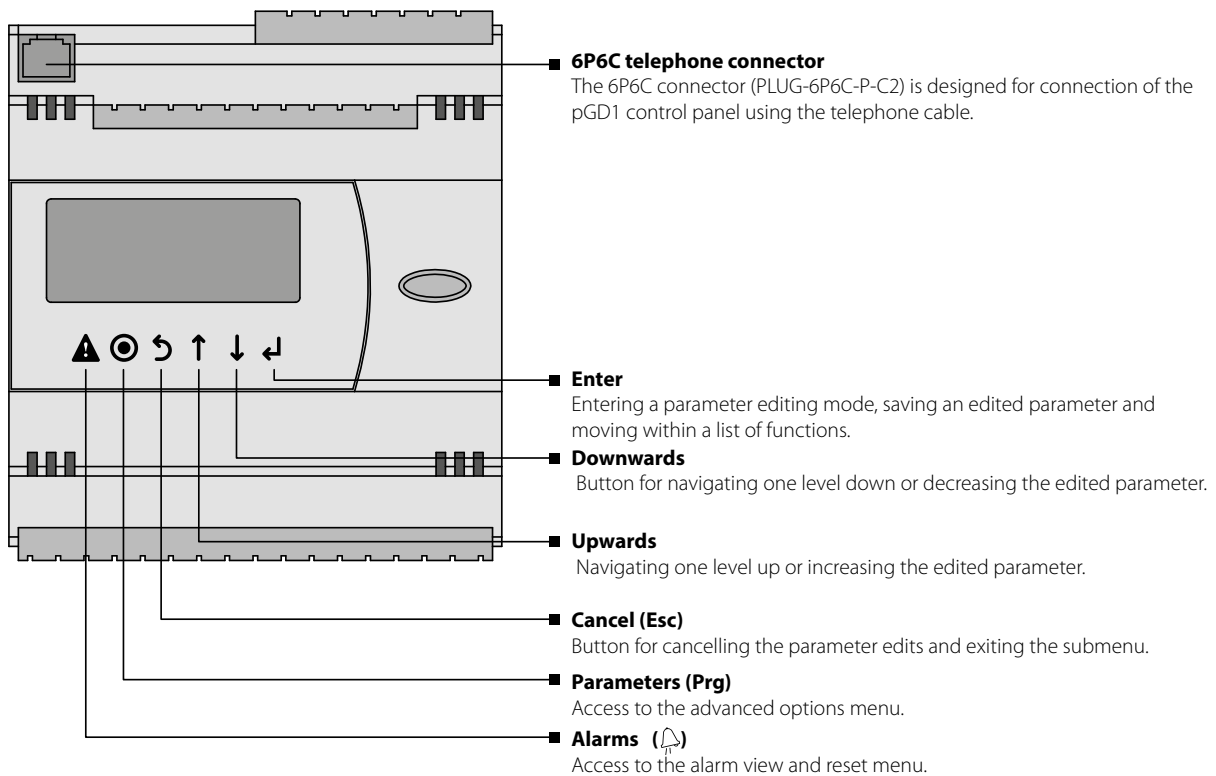

UNIT START

When the unit is connected to power mains the controller loads and goes to the main page.
If no action is taken in any menu within 5 minutes, the system will reload to the main page.



MAIN PAGE

The main page opens after confirmation of the unit switching on.

Press for accessing the setup menu.

Press to navigate between the entries of the main page.

Use the buttons and to edit the main menu entries.

Current room temperature/supply air temperature

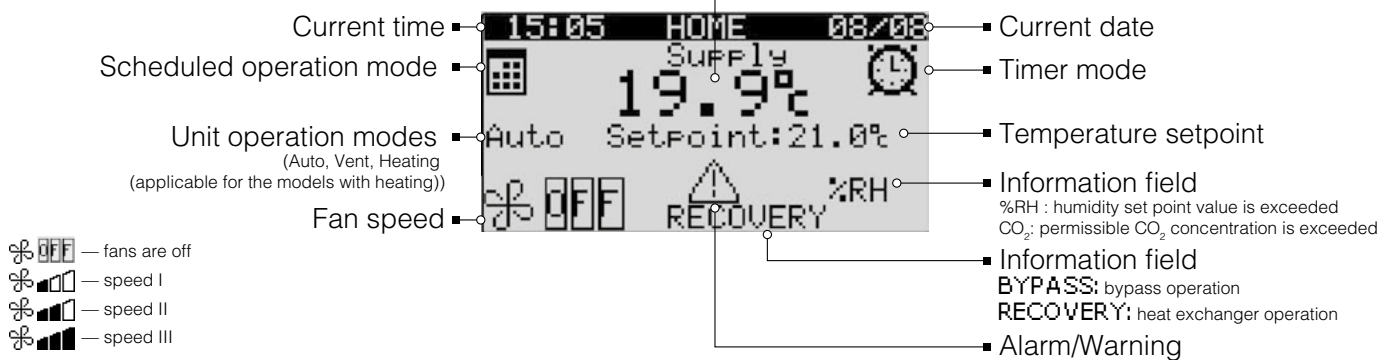

SETUP MENU

Press for accessing the setup menu from the main menu. The setup menu contains the general user parameters for unit operation setup. Use and to navigate between the menu entries.

Press to select an entry in the setup menu.

Press to return to the main menu.

SCHEDULER

Select **Schedule** in the setup menu and press .









The **Schedule** menu displays all the settings for the set day of the week.

Mode: scheduled operation mode status.

Off: scheduled operation is off.

On: scheduled operation is on.

If the scheduled operation mode is activated, the setpoint editing on the main page is disabled! Press  and  to change the status of the scheduled operation mode. After selecting the scheduled operation mode status press  to confirm. Select a week day using the buttons  and . Then press  to switch to the **Mode** menu entry.

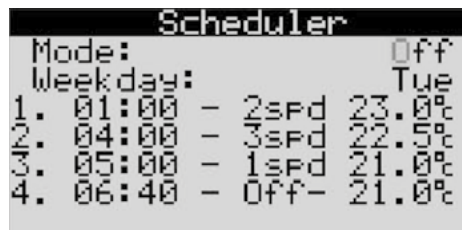



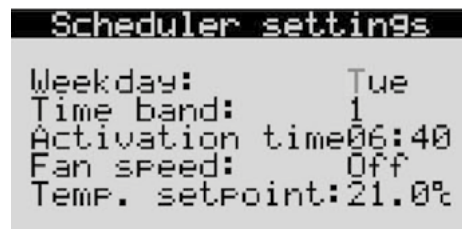

The display shows the settings for the selected day of the week. Each day has four time ranges with set start time, fan speed and temperature settings. Start of each next time range means the end of the previous one.

Press  to return to the setup menu.

Press  to go to the Scheduled operation mode settings.



Edit the parameters using the buttons  and . Then press  to confirm and proceed to the next parameter. After setting the Scheduled operation mode press  to save changes and keep it pressed for 3-5 seconds. Disappearance of the black bar at the top of the display means successful saving of the parameters.

Scheduled operation parameters:

Day of the week:

Mon: Monday

Tue: Tuesday

Wed: Wednesday

Th: Thursday

Fri: Friday

Sat: Saturday

Sun: Sunday

Period: period order number.

Activation time: activation time for set time period.



Fan speed: fan speed for set period.

Temperature setting: set temperature for set period.

TIMER

Select **Timer** in the setup menu and press .



Edit the parameter using the buttons  and . Then press  to confirm and proceed to the next parameter. Press  to return to the setup menu.

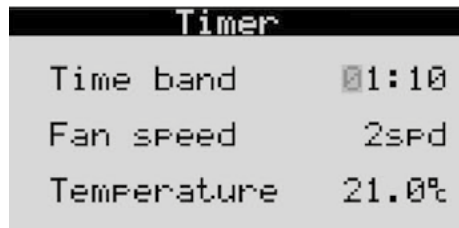

Timer settings:

Period: time range for operation of the unit with set parameters.

Speed: fan speed when the timer is activated.

Temperature: room temperature setpoint when the timer is activated.

Timer mode operation has higher priority as compared to the scheduled operation. If both the scheduled operation mode and the timer are activated, the unit operates according to the timer settings.

If the unit is equipped with external sensors, their activation has a higher priority than timer operation.

Date and time

Select **Date & time** in the setup menu and press .

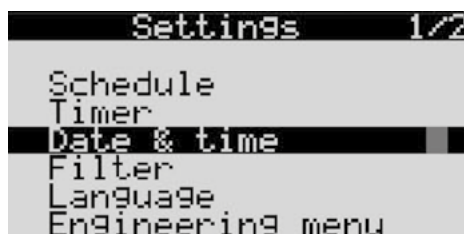



Press  to navigate between the date and time menu entries.

Edit the parameter using the buttons  and . Then press  to confirm and proceed to the next parameter. Press  to return to the setup menu.



FILTER

Select **Filter** in the setup menu and press . The parameters of this entry are not editable and are for reading only. Press  to return to the setup menu.



Filter parameters:

Current time: current filter operating time.

Set time: set filter replacement periodicity.

Recording frequency: periodicity of data recording into non-volatile storage. Upon elapsing of the time to filter replacement the display shows the filter replacement or cleaning indicator.

Reset time: reset of the filter timer after its replacement. After pressing **Reset time**, please confirm the action.

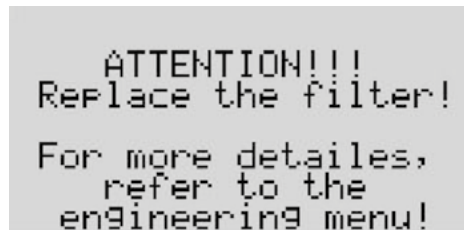

Contact the Seller for filter replacement.

Language



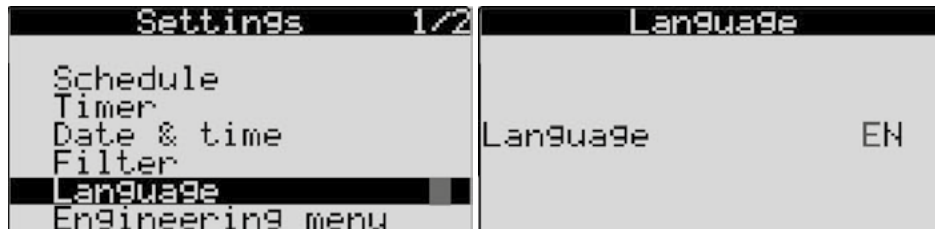

Select **Language** in the setup menu and press . Select a required language using by pressing  and . Then press  to confirm.



ENGINEERING MENU



**THE SERVICE SETTINGS ARE PROGRAMMED AT THE FACTORY.
THESE SETTINGS MAY BE CHANGED ONLY BY QUALIFIED SPECIALISTS UPON
ENTERING THE SERVICE PASSWORD.
CHANGING OTHER PARAMETERS DOES NOT REQUIRE A SERVICE PASSWORD.**

Select **Engineering menu** in the setup menu, press  and enter the password to engineering menu. Set the first password digit using the buttons  and . Then press  to confirm and proceed to the next step. If the password is entered correctly, the Engineering menu will open after entering the last digit of the password. Otherwise access to the Engineering menu remains disabled. Press  to return to the setup menu.





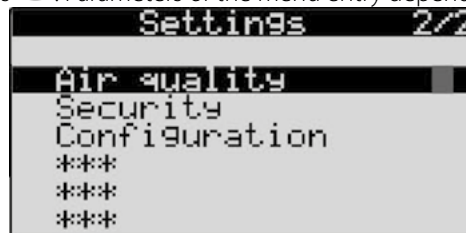

Description of the Engineering menu is available for service engineers only.

AIR QUALITY

Select Air quality in the setup menu and press . Parameters of the menu entry depend on the unit type.



For the units with integrated CO₂ sensor

Edit the **Threshold** parameter using the buttons  and . Then press  to confirm. Press  to return to the setup menu.

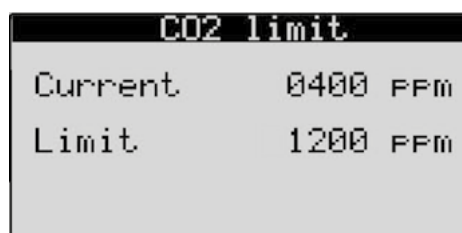

The display shows current sensor readings and the maximum set point. If the current sensor readings exceed the maximum set point, the integrated CO₂ sensor maintains the set CO₂ concentration by means of controlling the fan speed. If the current sensor readings fall below the set point, the unit reverts to the set operation mode.

For the units with integrated VOC sensor

Edit the **Threshold** parameter using the buttons and . Then press to confirm. Press to return to the setup menu.

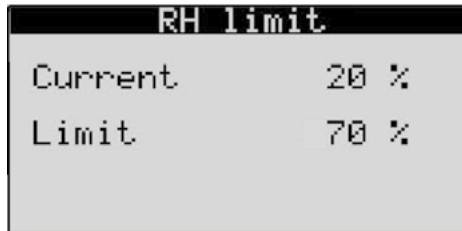

The display shows current sensor readings and the maximum set point. If the current sensor readings exceed the maximum set point, the unit will maintain the set air quality by means of controlling the fan speed. If the current sensor readings fall below the set point, the unit reverts to the set operation mode.

Security

Select **Security** in the setup menu and press . Use the and buttons to select the desired menu item and press to enter.

Security menu:

Log Out: logging out and display locking.

Change password: changing password for the user login.

Auto lock: setup of the automatic display lock.

LOG OUT





In the **Security** menu select the **Log Out** item and press to lock the display or to return to the **Security** menu. To unlock the display press and enter the password (default password: 0000).

CHANGE PASSWORD

In the **Security** menu select the **Change password** item and press to start editing the password. Set the first password digit by pressing and . Then press to confirm and proceed to the next parameter. In case of a wrong entry of the old password, the respective message will appear.



Auto Lock

In the **Security** menu select the **Auto Lock** item and press  for setting the display locking or  to return to the **Security** menu. Edit the parameters using the buttons  and . Then press  to confirm and proceed to the next parameter.



Auto lock: activation/deactivation of the display locking.

Time: time setting for automatic locking of the display (from 1 up to 30 minutes).

Press  to unlock the display. Then enter the password.



CONFIGURATION

In the setup menu select the **Configuration** item and press . Use the  and  buttons to select the desired menu item and press  to enter.

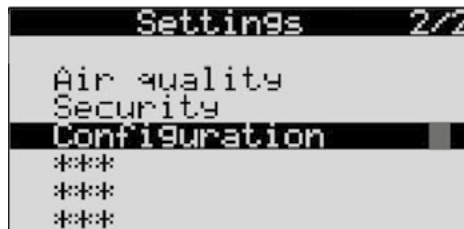

Edit the parameters by pressing  and . Press  to confirm and proceed to the next parameter.

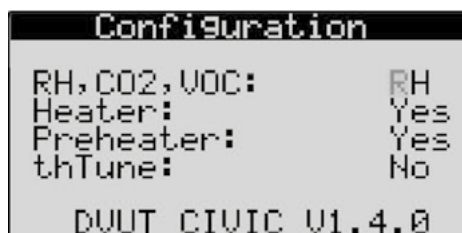

Configuration menu:

RH, CO₂, VOC: optional sensors selection.

Reheating: activation/deactivation of the reheater.

Preheater: activation/deactivation of the preheater.

