

**TRANSFORMER-TYPE
SPEED REGULATORS
RSA5E-..-M SERIES**

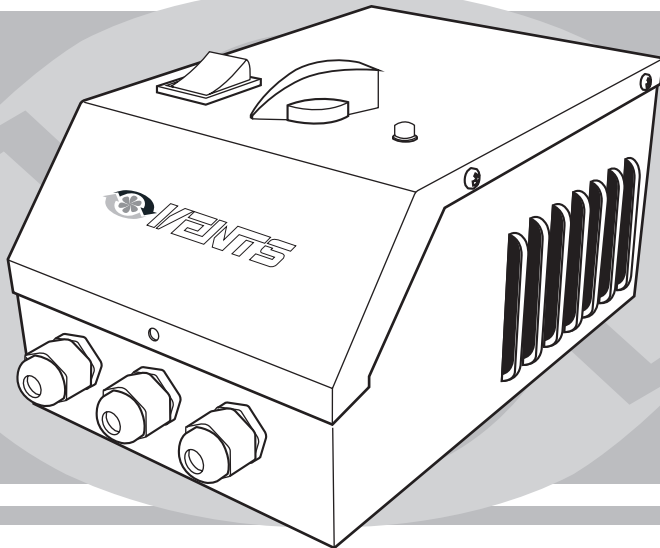

CONTENTS

Purpose	3
Package Contents	3
Technical Specifications	3
Design and Operating Principle	4
Safety Precautions and Warnings	5
Installation and Setup.....	6
Technical Maintenance	11
Transportation and Storage Regulations	11
Warranty	11

PURPOSE

Speed regulators RSA5E-.-M. series are used to control the output rate of single-phase fans. The regulators are equipped with an integral in motor protection device which cuts off the power on actuation of the thermal relay built into the fan electric motor. The power supply is restored automatically.

Package Contents

- Automatic transformer 1 piece
- User's Operation Manual 1 piece
- Packing 1 piece

TECHNICAL SPECIFICATIONS

Designation	RSASE-2-M	RSASE-3-M	RSASE-4-M
Supply Voltage	230V/50 Hz		
Fan Motor Nominal Voltage	230V/50 Hz		
Nominal Load Current (A)	2,0	3,0	4,0
Fuse,(A)	2,5	3,15	5,0
Lead-In: terminal block, screw-type	0.5..2.5 mm ²		
Operating Ambient Temperature	+5°C..+40° C		
Dimensions, (mm)	226x144x120	241x164x138	241x184x132
Weight (kg)	3,4	4,1	4,5
Protection Class	IP21		

DESIGN AND OPERATING PRINCIPLE

The regulator casing is made of metal. The regulator has five speeds selectable with the knob on the casing. The unit has an ON/OFF button. There are terminals for connection to an indoor thermostat or TC freezing protection thermostat, and on terminal tripping the power supplied to the fan motor is cut off. The regulator has 230 V (Max. 2 A/3 A/4 A) for connecting external equipment (e.g. air damper actuators).

Setting the ON/OFF button to the «OFF» position interrupts the current supply to the terminals and the fan electric motor. The device is equipped with an alarm lamp indicating regulator emergency. The regulator also enables connection of a remote-position control unit (P5-5) (see connection diagrams).

The unit is a single-phase transformer with the output rate of 110V- 130V - 160V - 190V - 230V., when powered from 220V, 50 Hz mains. The front panel has the ON / OFF button — 1 (see Fig. 1), speed selection knob — 2, alarm lamp — 3 which indicates regulator emergency operation. The device is equipped with the fan motor circuit breaker which disrupts the feed circuit on actuation of the thermal contact in the fan motor on terminal TK (see Fig. 4).

The regulator design also enables connection of an indoor thermostat or freezing protection thermostat to terminal TC (see Fig.4). Opening of the thermostat contacts disconnects the voltage supply to the fan motor.

Alarm lamp activates on opening of the thermal contact or the thermostat contacts.

The regulator also has terminals U1, U, and N (see Fig.4) enabling connection of external equipment (e.g. air damper actuators). Switching button 1 to «OFF», opening of the thermal contact or thermostat contacts the current supply to terminals U1, N and the fan electric motor is cut off. Contact U constantly remains under 220V/50 HZ voltage (used for electric actuators of electric dampers which are not equipped with a return spring).

The regulator can be controlled remotely as necessary by connecting the remote-position control panel (P5-5) (see Connection Options).

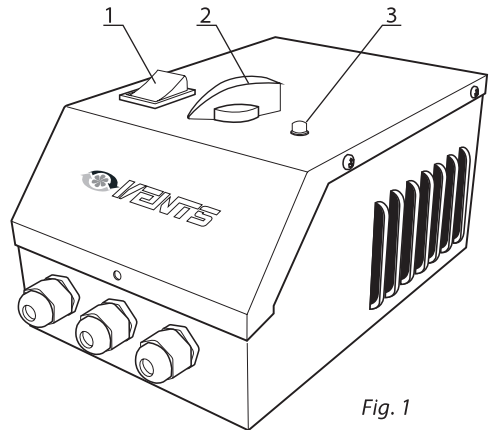

Fig. 1

SAFETY PRECAUTIONS AND WARNINGS

ATTENTION! The regulator application range is limited by the fan electric motor characteristics:

- The fan electric motor must be designed for TRIAC voltage regulation.
- The downward regulation range is selected based on the fan parameters. The entire fan regulation range must be within its operating envelope to prevent the fan motor breakdown.

- ⚠ The speed regulator and its connected equipment may present an electric shock hazard. Therefore, the device shall be connected and operated only by adequately qualified staff familiar with this manual. The speed regulator belongs to electrical machinery with voltages up to 1,000 V. The device must be disconnected from the power mains for any and all operations with the device internals.
- ⚠ The speed regulator shall only be used with single-phase motors.
- ⚠ The total current consumption of the electrical appliances connected to the device shall not exceed the limit value (see Technical specifications). The device should not be operated under the limit load current.
- ⚠ The speed regulator must be properly earthed.
- ⚠ Use the device with due caution. Do not subject it to shocks and overloads or expose it to liquids and dirt. Should any foreign objects penetrate onto the regulator circuit board, disconnect the unit from the mains and remove them.
- ⚠ Do not apply overvoltage to any of the speed regulators parts while testing the device (e.g. with a megohmmeter etc.). Disconnect the cable from the speed regulator prior to any measurements on the cable or motor!

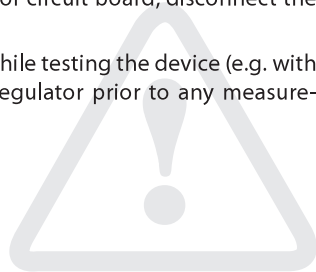

DO NOT

- ⊗ Operate the device in the presence of smoke or smell commonly associated with burning insulation, elevated noise or vibration, in case of structural integrity loss or formation of cracks in the casing or with broken connectors;
- ⊗ Cover the device with any materials, mount any gauges and objects on top, block the vents or fill them with any foreign objects;
- ⊗ Do not use the device in areas with an explosive or chemically aggressive environment detrimental to metals and insulation or under the influence of droplets or spray; do not use outdoors;
- ⊗ Connect any electric motors (individual or part of any equipment) with the phase current consumption (usually stated on the nameplate) in excess of the limit phase load current for the device;
- ⊗ Connect the device output terminals to the power mains.



INSTALLATION AND SETUP

ATTENTION!

Following the device transportation or storage under temperatures below zero let the unit warm up in the specified operating conditions for at least 4 hours.

- Check the device visually for any damage to the casing;
- Remove the front panel by unscrewing self-tapping screws 7 (see Fig. 2);
- To facilitate installation unplug connector 6 (see Fig. 3);
- Secure the regulator to the mounting surface using mounting holes 2 in the rear wall of the unit (see Fig. 2);

ATTENTION!

**MOUNT THE DEVICE
VERTICALLY FOR
PROPER OPERATION**

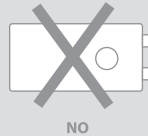

- Complete the electrical connections according to the wiring diagram (see Fig. 4). The external wires are connected to the device by means of bolt-and-nut terminals 5 (see Fig. 3). The cables are routed into the unit through sealed lead-ins 4 (see Fig. 3). The external lead-in (220V/50Hz) must be equipped with an automatic switch built into the stationary wiring.

ATTENTION! If the thermal contacts of the fan electric motor or the thermostat are not connected to the regulator, bridge contacts TC or TK correspondingly (see Fig. 4)

- Plug in connector 6 (see Fig. 3) and replace the front cover.
- Supply the power voltage and start the device.»

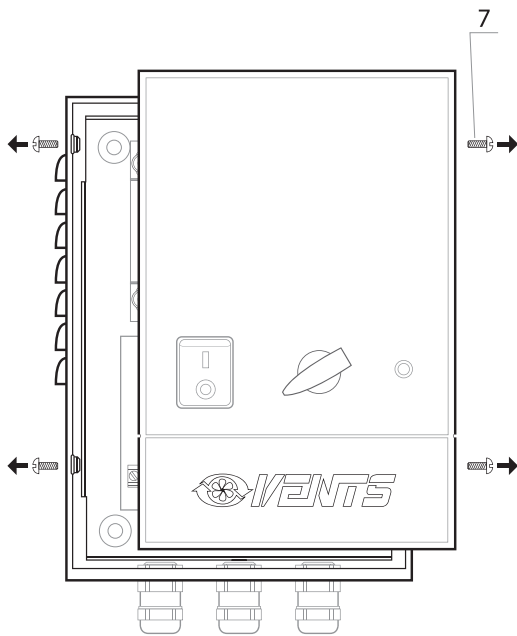

Fig. 2

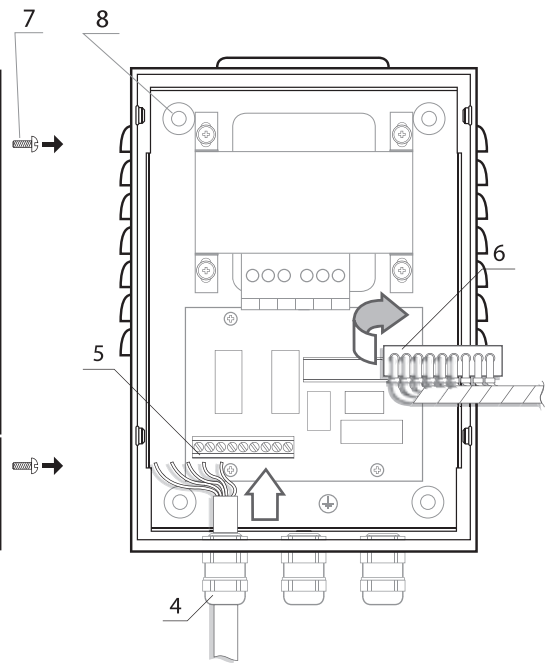
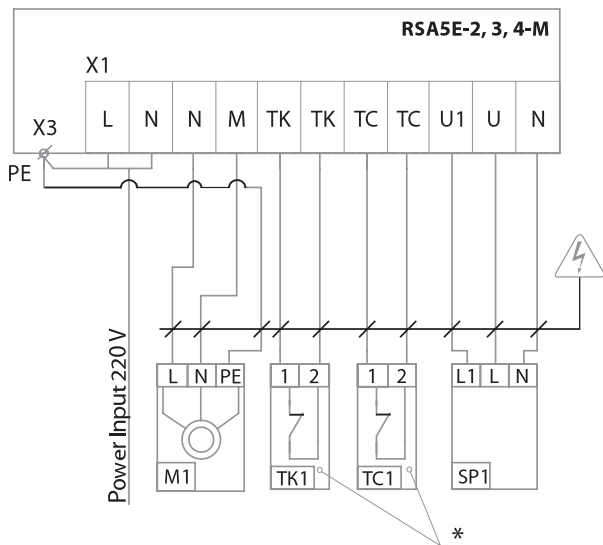

Fig. 3

CONNECTION DIAGRAM



Design.	Designation
M1	Fan Motor
TK1	Motor Thermal Protection
TC1	«Indoor thermostat or calorifier «freezing danger» thermostat»
SP1	Air Damper Actuator



Fig. 4.

* — The regulator may be operated without thermal protection (TK1) in which case bridge TK terminals. The regulator may be operated without the thermostat (TC1) in which case bridge TC terminals.

CONNECTION OPTIONS

OPTION NO. 1

RSA5E-...-M

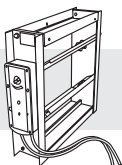
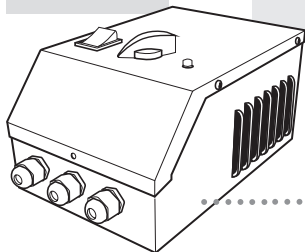

Air Damper
Actuator

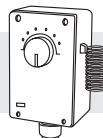

«Freezing Danger»
Thermostat

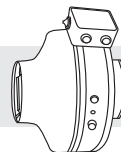

Fan



CONNECTION OPTIONS

OPTION NO. 2

RSA5E-...-M

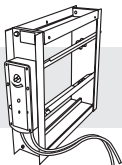
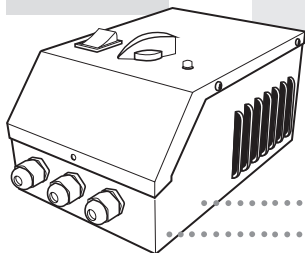

Air Damper
Actuator

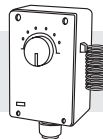

«Freezing Danger»
Thermostat

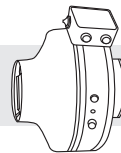

Fan

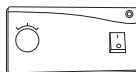

Remote Control Panel P5-5

TECHNICAL MAINTENANCE

- Periodically clean dust, fibres and other contamination from the ventilation holes.
- Make sure the external wires are tightly connected to the screw terminals of the device.

TRANSPORTATION

The device shall be carried in the manufacturer's packing without limitation to the means of transport, distance or speed. Once received by the user the devices shall be stored in the original packing at temperatures ranging from -40 to +35 °C and relative humidity up to 80%. The storage premises shall be free from dust and corrosive acid or alkaline vapours.

WARRANTY

The manufacturer warrants trouble-free operation of the speed regulator over the period of 12 months from the sale date within the warranty storage period. The warranty storage period is 24 months from the manufacturing date. If the sale date and vendor's stamp are missing, the warranty period shall be calculated from the manufacturing date.

The customer shall be entitled to free repair of the device in case of any malfunction of the regulator occurring through the manufacturer's fault within the warranty period.

ATTENTION!

The manufacturer shall not be liable for any injuries or damage caused by non-compliance with the installation and operation regulations set forth herein.

ATTENTION!

Check the regulator certificate of sale and acceptance for completeness (the required information includes the manufacturing and sale dates, manufacturer's and vendor's stamps).

WARRANTY SERVICE IS DENIED IN THE FOLLOWING CASES:

- Violation of the storage, transportation, installation and operation rules set forth herein;
- Failure to present the original certificate of sale and acceptance providing evidence of sale;
- Missing warranty card;
- Device repair by unauthorized persons and entities;
- Mechanical damage, traces of chemicals and penetration of foreign objects
- Damage caused by force majeure consequences (e.g. fire, lightning strike, flood, accident etc.);
- Misuse of the device;
- Connection to the power mains non-compliant with the required parameters specified in p.3 of the Operation Manual;
- Connection of loads with current consumption in excess of the maximum permissible current as specified in p.3 of the Operation Manual.

WARRANTY CARD

Acceptance Inspector's Stamp _____

Manufacturing Date _____

Shipment Date _____

Full Name _____

Date _____

Signature _____

NOTES

V47-1EN-01