

Series  
**VENTS VPA**



A16 control panel

Supply units with the air flow up to **1520 m<sup>3</sup>/h** in the compact sound- and heat-insulated casing with electric heater.

**Description**

The fan unit provides filtration, heating and supply of fresh air to premises with the air flow from 200 up to 1500 m<sup>3</sup>/h.

**Casing**

The casing is made of aluzinc with internal heat- and sound-insulating 25 mm layer of mineral wool.

**Filter**

Integrated panel G4 filter ensures sufficient supply air purification.

**Heater**

Electric heating battery is designed for supply air heating during winter and off-season time.

**Fan**

Centrifugal fan with backward curved blades and built-in overheating thermostat with automatic restart. The motor ball bearings are maintenance-free and are designed for at least 40 000 hours service life.

**Control and automation**

Integrated control and automation system for air flow control and setting supply air temperature. The unit may be controlled from the external control panel fixed on 10 m wire delivered as a standard.

**Control and protection functions**

- ▶ switching the unit on/off;
- ▶ maintaining supply air temperature set from the control panel by means of triac heating capacity regulation;
- ▶ fan speed control by means of the control panel (3 speed modes);
- ▶ working-out of the required patterns during the unit switching on and off;
- ▶ the unit daily or week timer operation;
- ▶ active overheating protection of heating elements;
- ▶ disabling electric air heating battery operation when the motor is not running;
- ▶ electric heater overheating protection by means of two thermostats;
- ▶ filter clogging control through the differential pressure sensor;
- ▶ actuating the air damper;
- ▶ relay input from an external sensor (humidistat, CO<sub>2</sub> sensor, motion sensor) to switch the fan to maximum speed;
- ▶ input for alarm fire fighting signal.

**Mounting**

Air supply unit can be mounted on the floor, attached to a ceiling with a seat angle with anti-vibration mounts or attached to a wall by means of the brackets. The unit can be mounted either in service spaces (balcony, storage room, underground floor, roof space etc.) or in the main space by placing the unit above the suspended ceiling or in the pocket. The unit can be mounted in any position except for the vertical one with vertical air downstream because tubular heating elements are not allowed under the fan. Free access to the unit shall be provided for maintenance and filter cleaning. The service panel is placed on the top. The control block is on the right.

**Designation key**

Series		Air duct diameter	Electric heater power [kW]	Phase	Integrated control system
<b>VENTS VPA</b>	1: high-powered motor	100; 125; 150; 200; 250; 315	1.8; 2.4; 3.4; 3.6; 5.1; 6; 9	1: single phase 3: three phase	<b>LCD:</b> integrated automation with A16 control panel

**Accessories**



### Technical data

	VPA 100- 1,8-1	VPA 125- 2,4-1	VPA 150- 2,4-1	VPA 150- 3,4-1	VPA 150- 5,1-3	VPA 150- 6,0-3	VPA 200- 3,4-1	VPA 200- 5,1-3	VPA 200- 6,0-3	
Voltage [V/50 Hz]	1~230		1~230		3~400		1~230		3~400	
Maximum fan power [W]	73	75	98			193				
Fan current [A]	0.32	0.33	0.43			0.84				
Electric heater power [kW]	1.8	2.4	2.4	3.4	5.1	6.0	3.4	5.1	6.0	
Electric heater current [A]	7.8	10.4	10.4	14.8	7.4	8.7	14.8	7.4	8.7	
Number of electrical heating elements	3	3	2	2	3	3	2	3	3	
Total unit power [kW]	1.873	2.475	2.498	3.498	5.198	6.098	3.593	5.293	6.193	
Total unit current [A]	8.12	10.73	10.83	15.23	7.83	9.13	15.64	8.24	9.54	
Air flow [m³/h]	190	285	425			810				
RPM [min <sup>-1</sup> ]	2830	2800	2705			2780				
Noise level at 3m [dBA]	27	28	29			30				
Transported air temperature [°C]	-25...+40		-25...+40			-25...+40				
Casing material	aluzinc			aluzinc			aluzinc			
Insulation	25 mm mineral wool		25 mm mineral wool			25 mm mineral wool				
Filter	G4			G4			G4			
Connected air duct size [mm]	100	125	150			200				
Mass [kg]	50			50			52			

### Technical data

	VPA 250-3,6-3	VPA 250-6,0-3	VPA 250-9,0-3	VPA 315-6,0-3	VPA 315-9,0-3	VPA-1 315-6,0-3	VPA-1 315-9,0-3
Voltage [V/50 Hz]	3~400			3~400			
Maximum fan power [W]	194			171		296	
Fan current [A]	0.85			0.77		1.34	
Electric heater power [kW]	3.6	6.0	9.0	6.0	9.0	6.0	9.0
Electric heater current [A]	5.3	8.7	13.0	8.7	13.0	8.7	13.0
Number of electrical heating elements	3	3	3	3	3	3	3
Total unit power [kW]	3.794	6.194	9.194	6.171	9.171	6.296	9.296
Total unit current [A]	6.15	9.55	13.85	9.47	13.77	10.04	14.34
Air flow [m³/h]	990			1190		1520	
RPM [min <sup>-1</sup> ]	2790			2600		2720	
Noise level at 3m [dBA]	30			30		30	
Transported air temperature [°C]	-25...+40			-25...+40		-25...+40	
Casing material	aluzinc				aluzinc		
Insulation	25 mm mineral wool			25 mm mineral wool			
Filter	G4			G4			
Connected air duct size [mm]	250			315			
Mass [kg]	52			62			

### Unit overall dimensions

Type	Dimensions [mm]					
	∅D	B	B1	H	L	L1
VPA 100	99	382	421.5	408	800	647
VPA 125	124	382	421.5	408	800	647
VPA 150	149	455	496,5	438	800	647
VPA 200	199	487	526,5	513	835	684
VPA 250	249	487	526,5	513	835	684
VPA 315	314	527	566,5	548	900	750

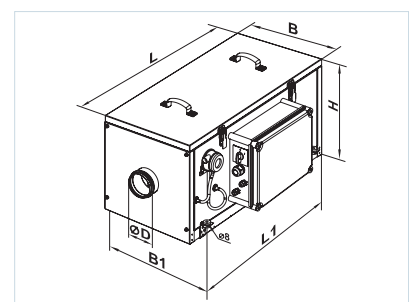

SUPPLY UNITS

VENTS VPA

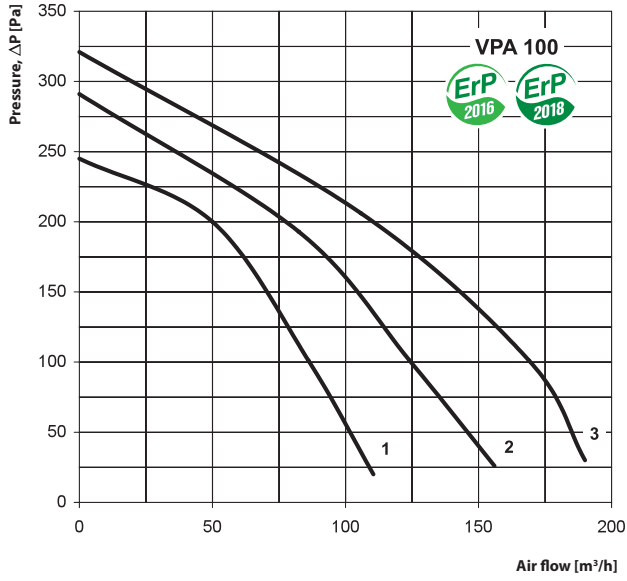

Sound-power level	Hz	Octave-frequency band [Hz]								
		Gen	63	125	250	500	1000	2000	4000	8000
$L_{WA}$ to inlet	dBA	50	30	47	47	35	40	37	28	16
$L_{WA}$ to outlet	dBA	58	39	50	56	49	45	42	33	23
$L_{WA}$ to environment	dBA	31	5	21	28	24	19	13	4	0

VENTS VPA

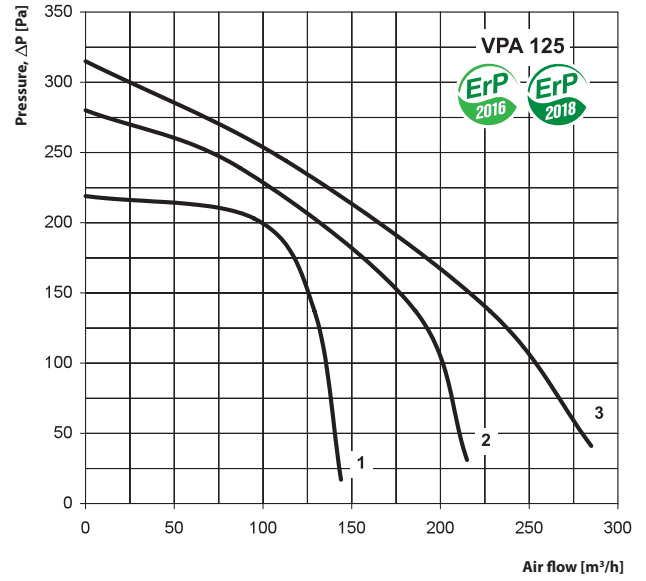

Sound-power level	Hz	Octave-frequency band [Hz]								
		Gen	63	125	250	500	1000	2000	4000	8000
$L_{WA}$ to inlet	dBA	52	31	48	48	36	41	40	32	18
$L_{WA}$ to outlet	dBA	62	40	53	56	52	47	47	37	23
$L_{WA}$ to environment	dBA	33	9	24	33	26	17	16	3	4

VENTS VPA

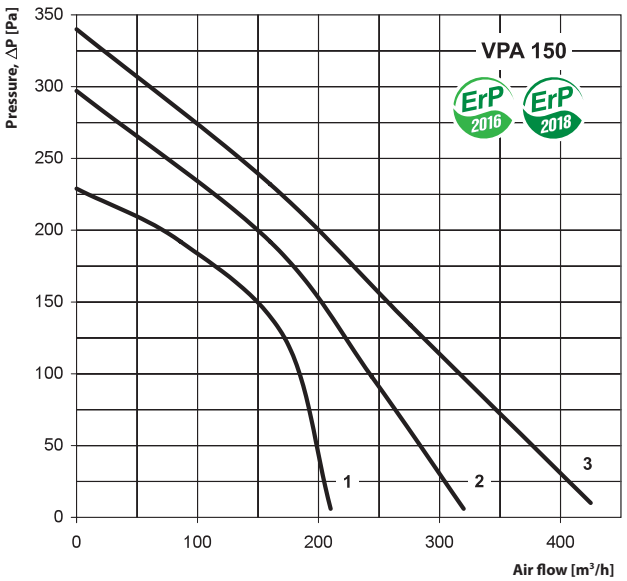

Sound-power level	Hz	Octave-frequency band [Hz]								
		Gen	63	125	250	500	1000	2000	4000	8000
$L_{WA}$ to inlet	dBA	65	37	53	63	50	53	53	45	30
$L_{WA}$ to outlet	dBA	63	22	43	53	52	57	57	46	36
$L_{WA}$ to environment	dBA	41	14	34	39	19	27	19	7	0

VENTS VPA

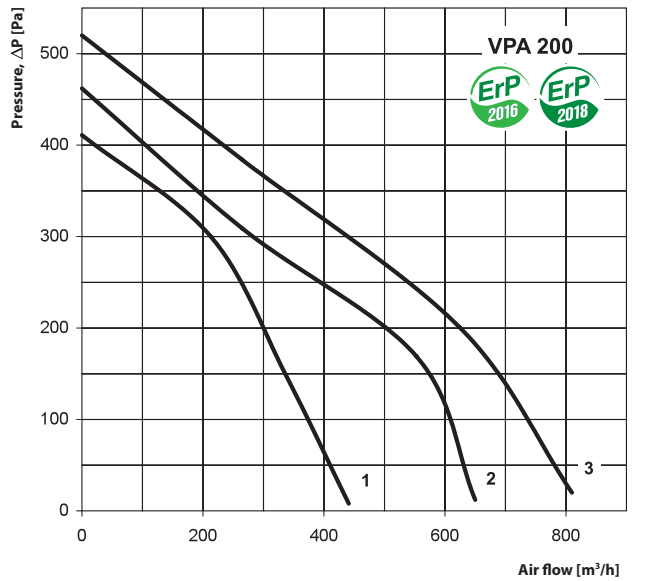

Sound-power level	Hz	Octave-frequency band [Hz]								
		Gen	63	125	250	500	1000	2000	4000	8000
$L_{WA}$ to inlet	dBA	65	41	58	59	56	60	62	56	41
$L_{WA}$ to outlet	dBA	71	46	57	63	64	66	66	58	45
$L_{WA}$ to environment	dBA	46	15	31	43	40	34	30	22	8

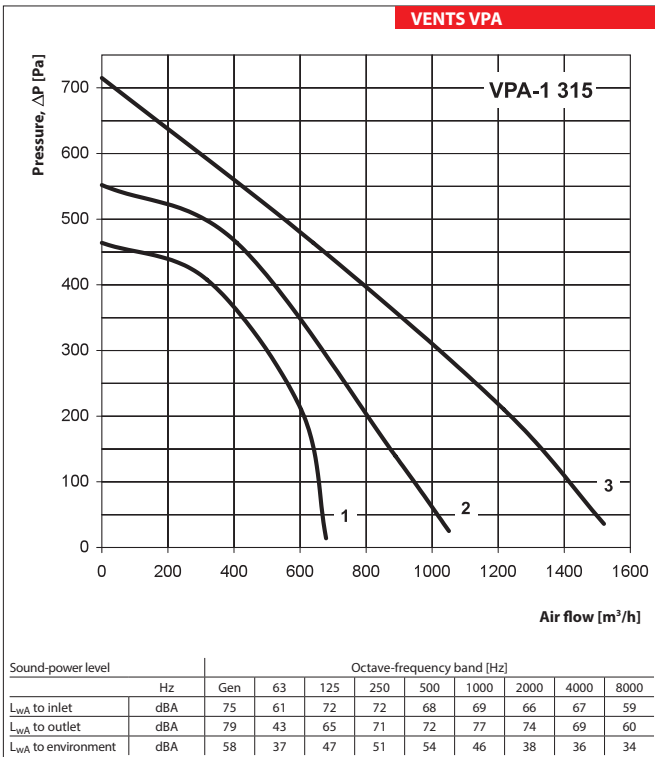
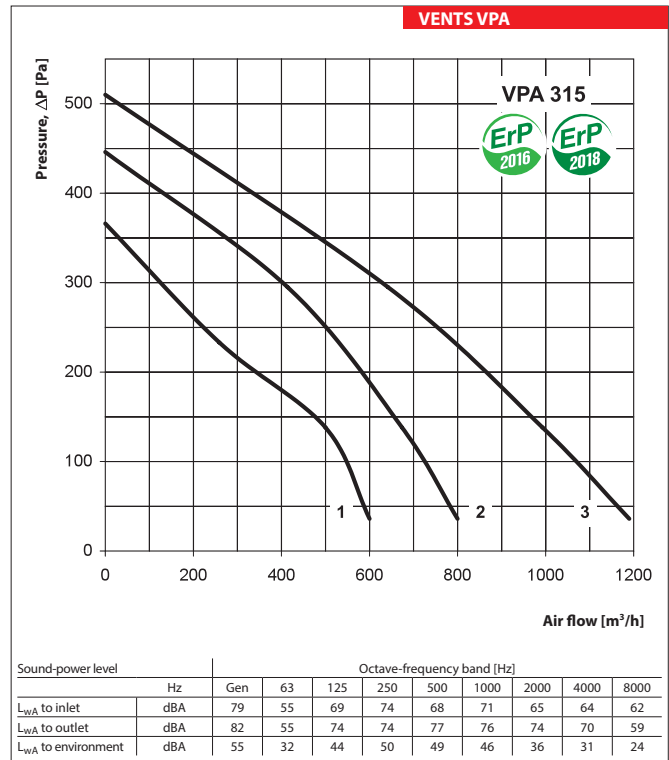
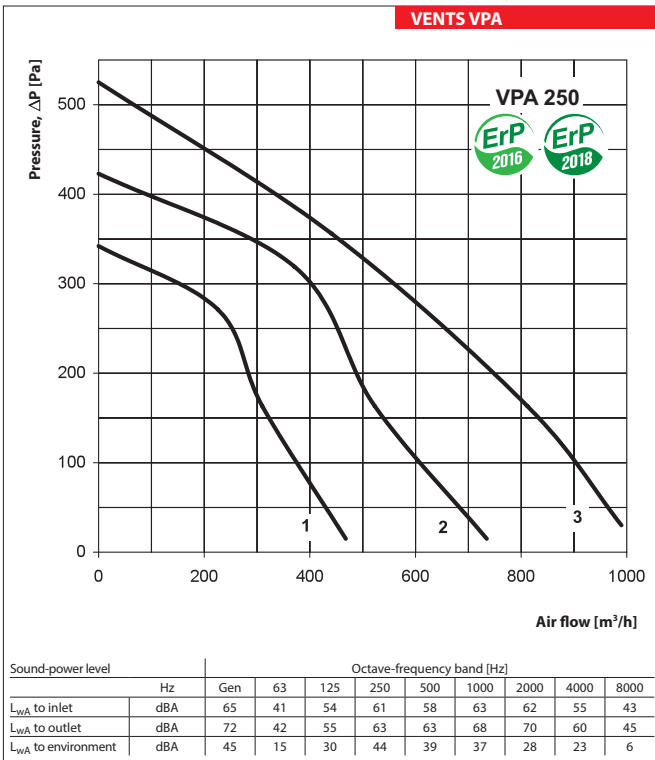

**Accessories to supply units**

Type	Replaceable filter	Filter type
VPA 100-1,8-1	SF 335x322x70 G4	panel filter
VPA 125-2,4-1		
VPA 150-2,4-1	SF 397x364x70 G4	panel filter
VPA 150-3,4-1		
VPA 150-5,1-3		
VPA 150-6,0-3		
VPA 200-3,4-1	SF 439x428x70 G4	panel filter
VPA 200-5,1-3		
VPA 200-6,0-3		
VPA 250-3,6-3	SF 475x470x70 G4	panel filter
VPA 250-6,0-3		
VPA 250-9,0-3		
VPA 315-6,0-3	SF 475x470x70 G4	panel filter
VPA 315-9,0-3		
VPA-1 315-6,0-3		
VPA-1 315-9,0-3		