

Series
VENTS
VUT/VUE 250 V mini



Air handling units in compact sound- and heat-insulated casing with vertical duct connections.
Maximum air flow – **260 m³/h**

■ **Description**

The VUT/VUE 250 H/V mini A12 air handling units are the fully-featured ventilation units that ensure air filtration, fresh air supply and stale air extract. During the operation process the extract air heat is transferred to the supply air through the plate heat exchanger.

■ **Modifications**

VUT 250 V mini A12: models with vertical duct connections, fans with AC motors with polystyrene heat exchanger.

VUT 250 H mini A12: models with horizontal duct connections, fans with AC motors with polystyrene heat exchanger.

VUE 250 V mini A12: models with vertical duct connections, fans with AC motors with a heat exchanger made of enthalpy.

VUE 250 H mini A12: models with horizontal duct connections, fans with AC motors with a heat exchanger made of enthalpy.

Series
VENTS
VUT/VUE 250 H mini

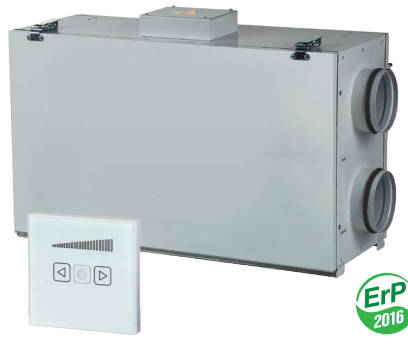

Air handling units in compact sound- and heat-insulated casing with horizontal duct connections.
Maximum air flow – **260 m³/h**

■ **Casing**

The casing of the VUT/VUE 250 V/H unit is made of aluzinc steel, internally filled with 20 mm mineral wool heat- and sound-insulating layer.

■ **Filter**

Two built-in filters with filtering class G4 provide efficient supply and extract air filtration. F8 filter is available as an option for supply air filtration.

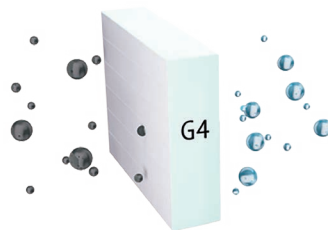

■ **Fans**

The unit is equipped with a supply and exhaust centrifugal fan with backward curved blades and integrated overheating protection thermostat with automatic restart. The motors and the impellers are dynamically balanced.

■ **Heat exchanger**

VUE mini: plate heat exchanger made of enthalpy with heat recovery efficiency up to 78 %. The applied heat exchanger enables not only heat but also humidity recovery, which helps maintaining a comfortable humidity level.

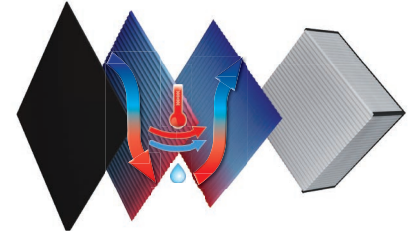

VUT mini: plate heat exchanger made of polystyrene. Whenever heat recovery is not required for unit operation, the heat exchanger block can be easily replaced by a summer block.

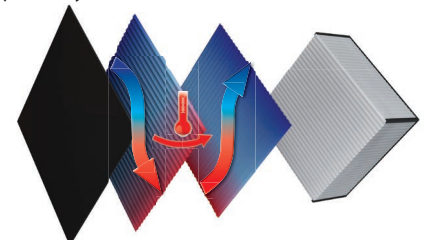

To prevent the heat exchanger freezing, electronic protection system is applied. It switches the supply fan off as the temperature sensor requires.

■ **Control**

The unit is equipped with the A12 (SRS-1) control panel. Speed and rotation control of the single-phase power-controlled motors allows turning the unit on/off and controlling its capacity.

■ **Installation**

Mounting to wall, floor or ceiling with fixing brackets. While mounting provide free access to the service panel for filter replacement and servicing. The correct mounted unit must provide condensate collecting and drainage.

Designation key

Series	Rated air flow [m³/h]	Spigot modification	Model	Casing colour	Integrated automation system
VUT: ventilation with heat recovery VUE: ventilation with energy recovery	250	V: vertical H: horizontal	mini	_: aluzinc White: white painted	A12: control panel (SRS-1)

Overall dimensions of units

Model	Dimensions [mm]					
	ØD	B	H	H1	L	L1
VUT/VUE 250 V mini	125	300	443	490	713	43
VUT/VUE 250 H mini	125	300	443	43	713	810

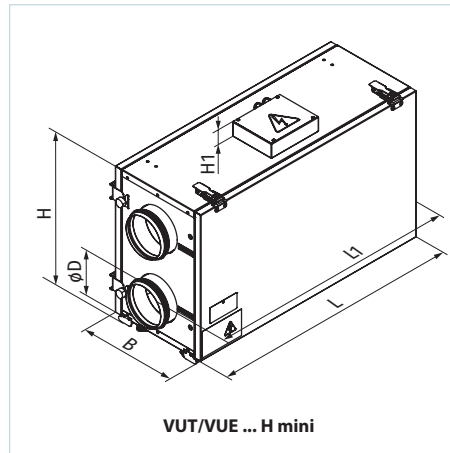
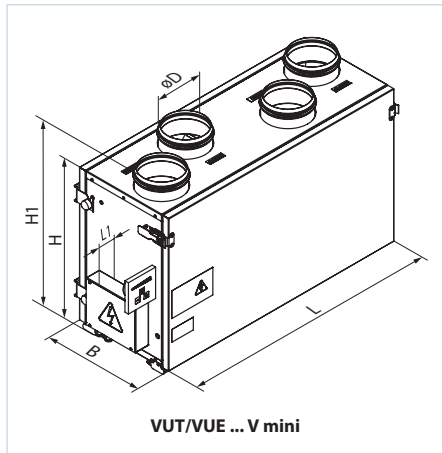







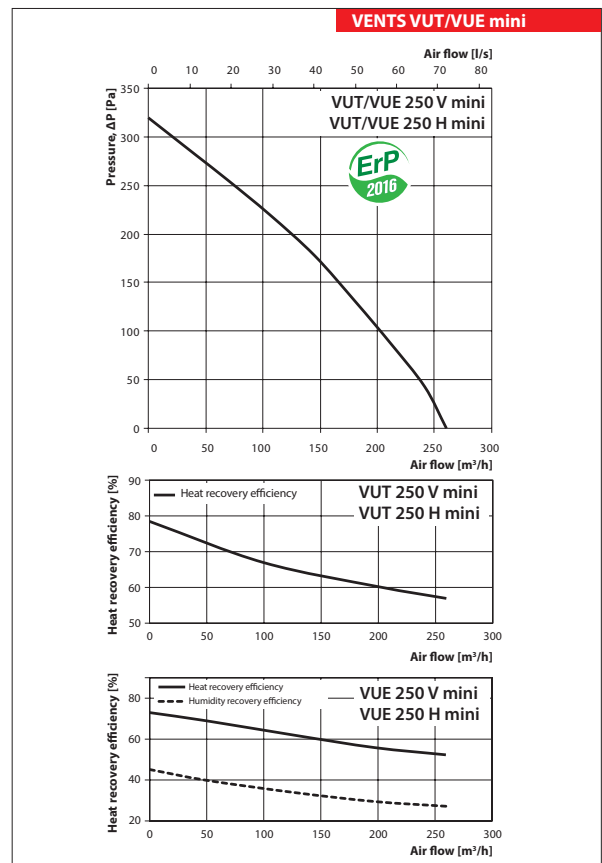

Technical data

	VUT 250 V mini VUT 250 H mini	VUE 250 V mini VUE 250 H mini
Unit voltage [V/50 (60) Hz]	1~230	
Power [W]	126	
Current [A]	0.6	
Maximum air flow [m³/h]	260	
RPM [min⁻¹]	2700	
Sound pressure level at 3 m distance [dBA]	28-47	
Transported air temperature [°C]	-25...+40	
Insulation	20 mm mineral wool	
Filter: extract	G4	
Filter: supply	G4 (F8 PM2.5 81 % – option)	
Connected air duct diameter [mm]	Ø125	
Heat recovery efficiency* [%]	57-78	52-73
Humidity recovery efficiency* [%]	-	27-45
Heat exchanger type	cross-flow	
Heat exchanger material	polystyrene	enthalpy

*Heat recovery efficiency is specified in compliance with EN308 EU.



Accessories for air handling units

Model	G4 panel filter	F8 panel filter	Silencers	Back valves	Air dampers	Clamps	Summer blocks	
VUT 250 V mini A12								
VUE 250 V mini A12	SF 240x184x40 G4	SF 240x184x40 F8	SR 125	SRF 125	KOM 125	KR 125	X 125	VL C4 200/240
VUT 250 H mini A12								
VUE 250 H mini A12								