

Series
VENTS VUTR PE EC



Air handling units in heat- and sound-insulated casing.
Air flow up to **710 m³/h**.
Heat recovery efficiency up to **87 %**.

■ **Description**

The air handling units VUTR PE EC are the fully-featured ventilation units that ensure air filtration, fresh air supply and stale air extract. The units are used in ventilation systems installed in various premises that require reasonable energy saving solutions and controllable ventilation systems.

■ **Modifications**

VUTR P(2)E EC models (with an electric heater).
VUTR P2E EC models with a low profile casing and 20 mm insulation.

■ **Casing**

Made of galvanized steel, internally filled with a mineral wool heat- and sound-insulating layer. The insulation thickness is 40 mm for the VUTR PE EC models and 20 mm for the VUTR P2E EC models. Unit maintenance is performed from the bottom panel side. The distinctive feature of the VUTR P2E EC units is a low profile casing.



■ **Filter**

Two built-in filters with filtering class G4 and F7 provide efficient supply air filtration. Extract air is cleaned by the integrated G4 filter.

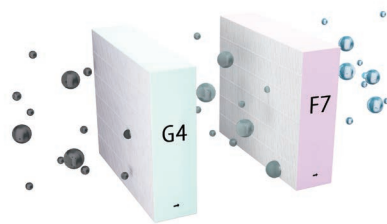

■ **Motor**

The units are equipped with high-efficient EC motors with an external rotor and a centrifugal impeller.

■ **Rotary heat exchanger**

Units equipped with a rotary heat exchanger. As compared to plate heat exchangers, the rotary heat exchangers are distinguished with no condensate forming, ability to maintain comfortable air humidity and extremely low freezing danger.

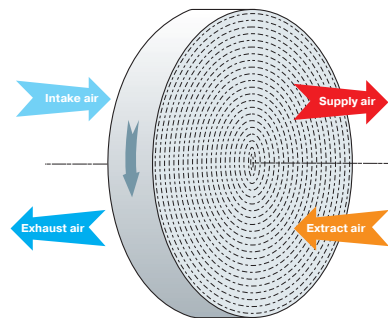

Rotary heat exchanger operation principle

■ **Heater**

The VUTR PE EC units are equipped (with an electric heater). If heat recovery is not sufficient to reach the set supply air temperature, the heater is activated to warm up supply air. The heaters are equipped with protecting devices to ensure safe and reliable operation of the unit.

■ **Automation**

The **VUTR PE/P2E EC A21** units are equipped with an integrated control system. The **A21** controller allows integrating the unit into the **Smart Home system** or **BMS (Building Management Systems)**. To control the unit using a mobile application via Wi-Fi, you need to download the VENTS Home mobile application.

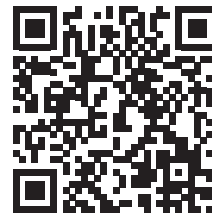

Google play

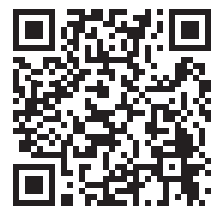

Download on the App Store





■ **Mounting**

The unit is designed for wall or floor mounting. The access for unit and filter maintenance is available from the front panel. The service and the back panels can be rearranged allowing connection both on the right and on the left side.

Designation key

Series	Heat exchanger type	Rated air flow [m ³ /h]	Spigot orientation	Casing design	Heater type	Motor type	Control panel
VENTS VUT	R: rotary	250; 350; 650	P: suspended mounting	_: standard (insulation thickness 40 mm) 2: low-profile (insulation thickness 20 mm)	E: (with an electric heater)	EC: synchronous electronically commutated motor	A21

Control and automation

Functions	A21
Control via Wi-Fi using a mobile application	+
Control via a wired remote control panel	A22 (option) 
Control via a wireless remote control panel	A22 Wi-Fi (option) 
Control via a wired remote LCD control panel	A25 (option) 
BMS	RS-485 WI-FI Ethernet MODBUS (RTU, TCP)
Service Vents Cloud Server	+
Speed selection	+
Filter replacement indication	according to hour meter readings
Alarm indication	full alarm description in the mobile application
Week-scheduled operation	+
Timers	+
Boost mode	+
Fireplace mode	+
Reheater connection	integrated in E models, external reheater cannot be connected
Cooler connection	option
Kitchen hood connection	option
Minimum supply air temperature control	+
Humidity control	option
CO ₂ controller	option
VOC controller	option
Fire alarm sensor connection	option

*Option. The functionality is available when you purchase the appropriate accessory.

Overall dimensions

Model	Dimensions [mm]					
	Ø D	Ø D1	L1	L	B	H
VUTR 250 PE EC	160	125	1100	1003	688	345
VUTR 250 P2E EC	160	125	1097	1002	666	245
VUTR 350 PE EC	160	125	1365	1270	818	361
VUTR 350 P2E EC	160	125	1457	1362	847	245
VUTR 650 PE EC	200	125	1542	1445	932	422

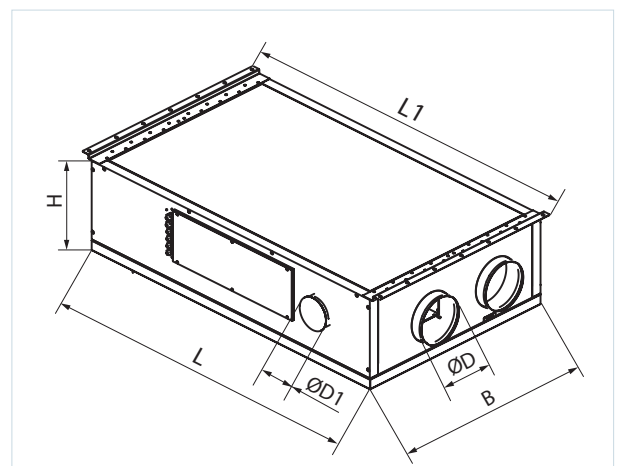

HEAT RECOVERY AIR HANDLING UNITS

Technical data

	VUTR 250 P2E EC	VUTR 250 PE EC
Unit voltage [V/50 (60) Hz]	1~220-240	
Maximum unit power (without an electric heater) [W]	128	135
Maximum unit power (with an electric heater) [W]	828	835
Maximum unit current (without an electric heater) [A]	0.9	1.0
Maximum unit current (with an electric heater) [A]	4.0	4.1
Maximum air flow [m ³ /h]	300	310
RPM [min ⁻¹]	2200	2200
Sound pressure level at 3 m distance [dBA]	23	21
Transported air temperature [°C]	-25...+40	
Casing material	galvanized steel	
Insulation	20 mm mineral wool	40 mm mineral wool
Extract filter	G4	
Supply filter	G4, F7	
Connected air duct diameter [mm]	160	
Weight [kg]	54	56
Heat recovery efficiency [%]	from 76 up to 87	from 71 up to 87
Heat exchanger type	rotary	
Heat exchanger material	aluminium	
SEC class	A	

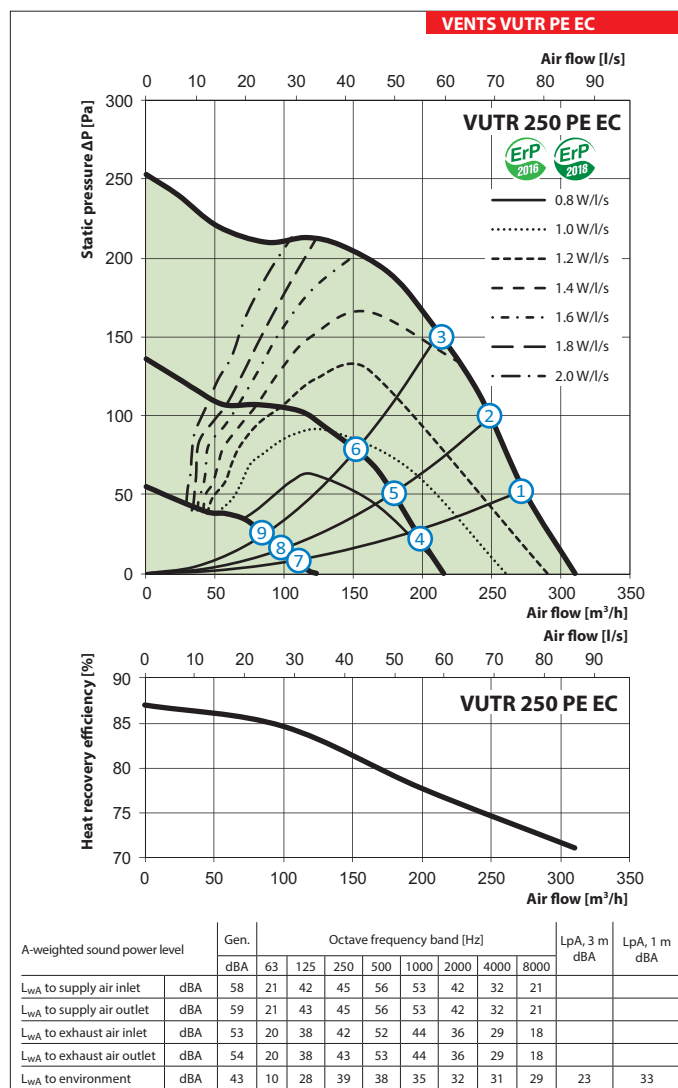
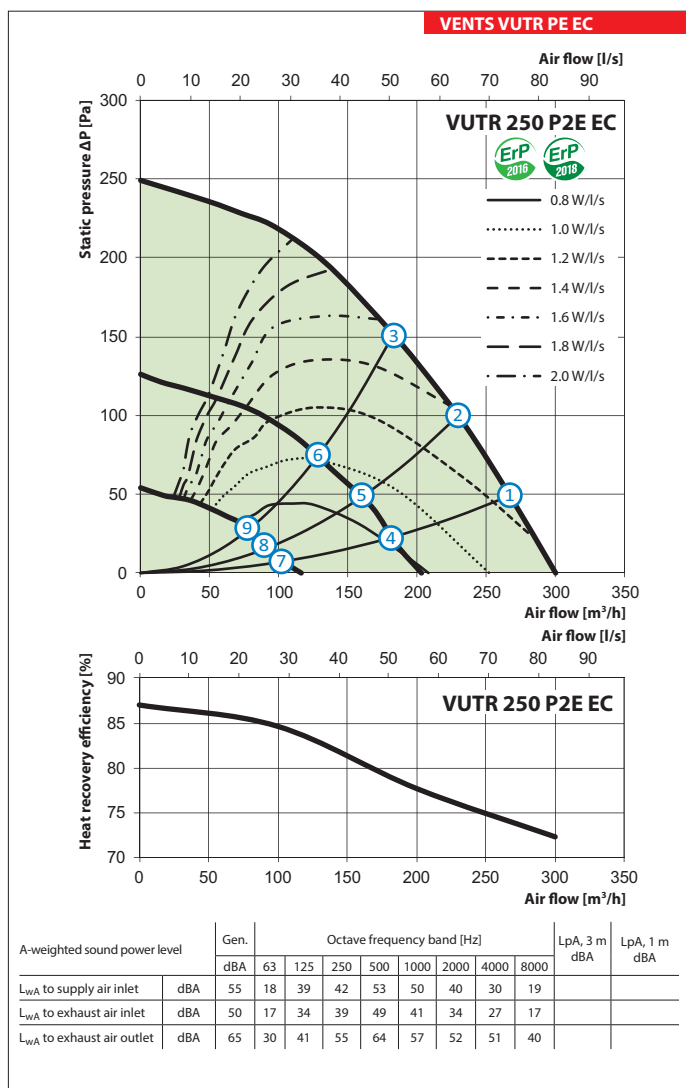

	VUTR 350 P2E EC	VUTR 350 PE EC
Unit voltage [V/50 (60) Hz]	1~220-240	
Maximum unit power (without an electric heater) [W]	200	185
Maximum unit power (with an electric heater) [W]	1600	1585
Maximum unit current (without an electric heater) [A]	1.3	
Maximum unit current (with an electric heater) [A]	6.9	6.9
Maximum air flow [m ³ /h]	400	430
RPM [min ⁻¹]	3200	3570
Sound pressure level at 3 m distance [dBA]	33	31
Transported air temperature [°C]	-25...+40	
Casing material	galvanized steel	
Insulation	20 mm mineral wool	40 mm mineral wool
Extract filter	G4	
Supply filter	G4, F7	
Connected air duct diameter [mm]	160	
Weight [kg]	79	82
Heat recovery efficiency [%]	from 73 up to 87	from 72 up to 87
Heat exchanger type	rotary	
Heat exchanger material	aluminium	
SEC class	A	

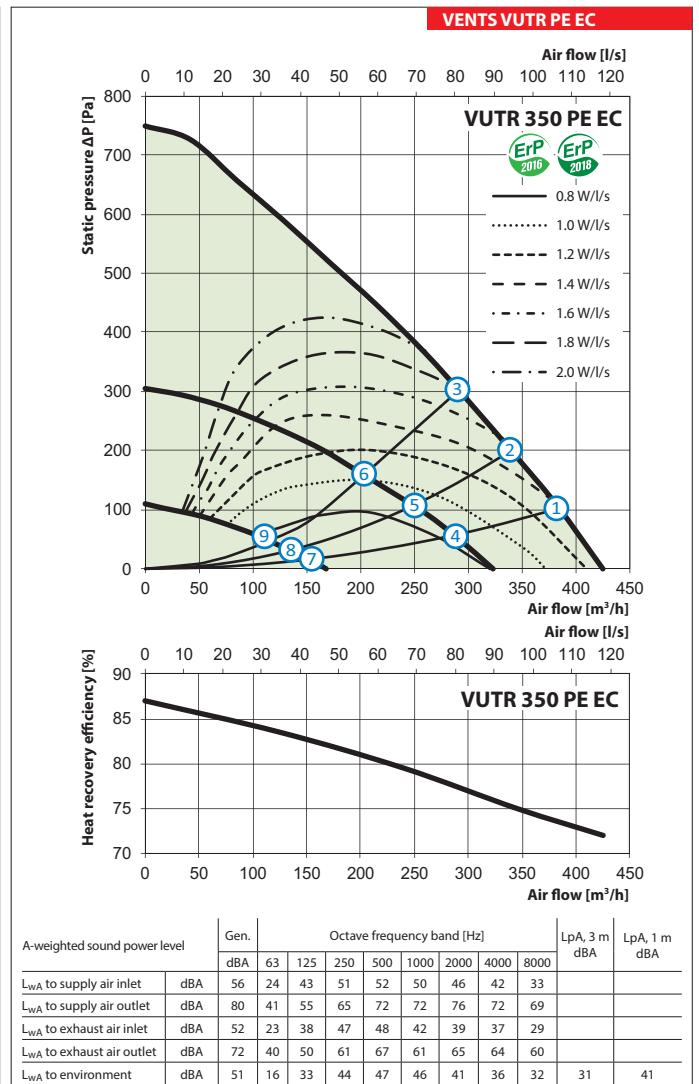
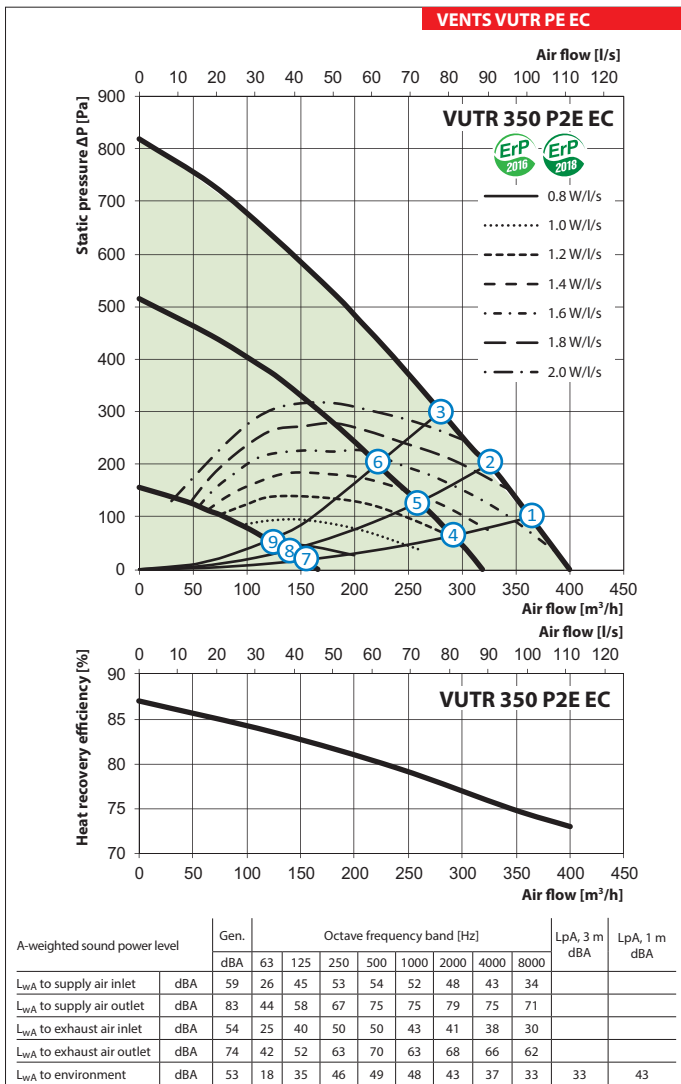

HEAT RECOVERY AIR HANDLING UNITS

Technical data

		VUTR 650 PE EC
Unit voltage [V/50 (60) Hz]		1~220-240
Maximum unit power (without an electric heater) [W]		367
Maximum unit power (with an electric heater) [W]		3167
Maximum unit current (without an electric heater) [A]		2.5
Maximum unit current (with an electric heater) [A]		13.7
Maximum air flow [m ³ /h]		710
RPM [min ⁻¹]		3600
Sound pressure level at 3 m distance [dBA]		36
Transported air temperature [°C]		-25...+40
Casing material		galvanized steel
Insulation		40 mm mineral wool
Extract filter		G4
Supply filter		G4, F7
Connected air duct diameter [mm]		200
Weight [kg]		104
Heat recovery efficiency [%]		from 80 up to 87
Heat exchanger type		rotary
Heat exchanger material		aluminium
SEC class		A

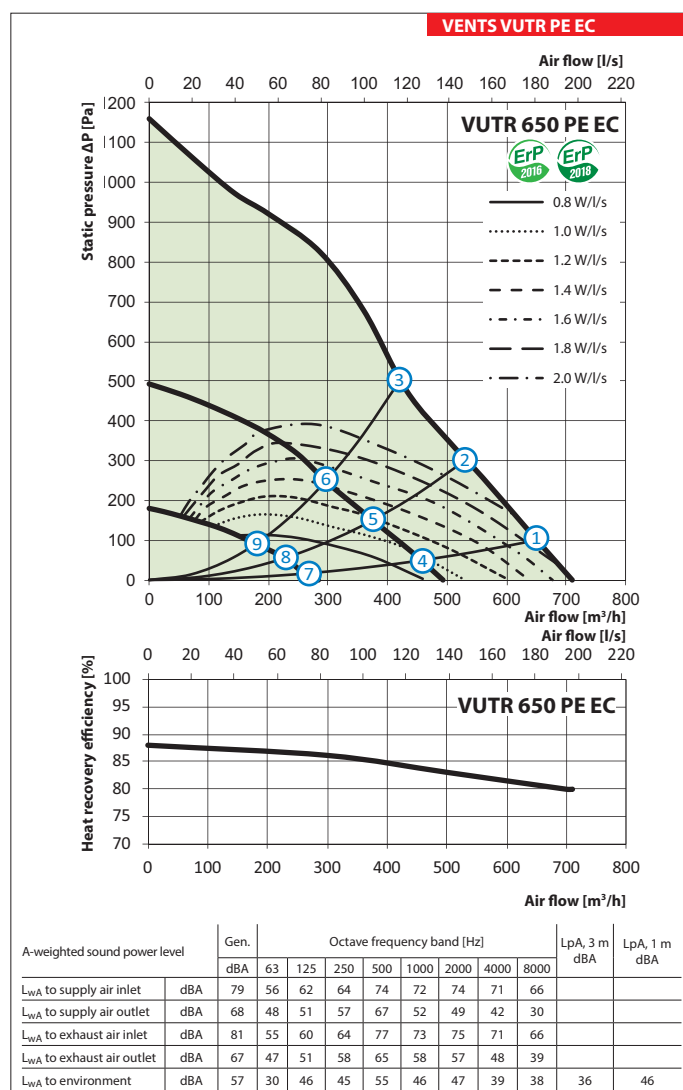

Point	Power [W]				
	VUTR 250 P2E EC	VUTR 250 PE EC	VUTR 350 P2E EC	VUTR 350 PE EC	VUTR 650 PE EC
1	93	101	172	154	342
2	89	115	171	151	342
3	77	80	167	149	342
4	41	45	125	116	122
5	39	42	124	116	122
6	38	40	122	115	122
7	17	17	98	76	34
8	17	17	97	75	33
9	16	16	97	63	33

Sound pressure level at 3 m distance [dBA]				
VUTR 250 P2E EC	VUTR 250 PE EC	VUTR 350 P2E EC	VUTR 350 PE EC	VUTR 650 PE EC
23 (33)	21 (31)	33 (43)	31 (41)	36 (46)
23 (33)	21 (31)	33 (43)	31 (41)	36 (46)
22 (32)	20 (30)	32 (42)	30 (40)	35 (45)
21 (31)	18 (28)	31 (41)	27 (37)	31 (41)
19 (29)	17 (27)	28 (38)	26 (36)	29 (39)
18 (28)	17 (27)	27 (37)	26 (36)	29 (39)
18 (28)	16 (26)	27 (37)	24 (34)	27 (37)
17 (27)	16 (26)	23 (33)	21 (31)	24 (34)
17 (27)	16 (26)	23 (33)	21 (31)	24 (34)

Accessories

Model	G4 panel filter	F7 panel filter	LCD control panel	Control panel	Control panel with Wi-Fi	VOC sensor (0-10 V)	CO ₂ sensor (0-10 V)
VUTR 250 P2E EC A21	SF 280x180x48 G4	SF 280x180x48 F7					
VUTR 250 PE EC A21	SF 260x220x48 G4	SF 260x220x48 F7					
VUTR 350 P2E EC A21	SF 372x180x48 G4	SF 372x180x48 F7	A25	A22	A22 Wi-Fi	DPWQ30600	DPWQ40200
VUTR 350 PE EC A21	SF 320x235x48 G4	SF 320x235x48 F7					
VUTR 650 PE EC A21	SF 378x295x48 G4	SF 378x295x48 F7					

Model	Humidity sensor (0-10 V)	Humidity sensor (NO)	Humidity sensor (0-10 V)	Kitchen hood	Back valves	Air dampers	Clamps	Electric actuator	
VUTR 250 P2E EC A21									
VUTR 250 PE EC A21									
VUTR 350 P2E EC A21	DPWC11200	HR-S	HV-2	KH-1	KOM 160	KRV 160	C 160	LF230	TF230
VUTR 350 PE EC A21									
VUTR 650 PE EC A21					KOM 200	KRV 200	C 200		

Application options

Ceiling connector with a disc valve



Manifold

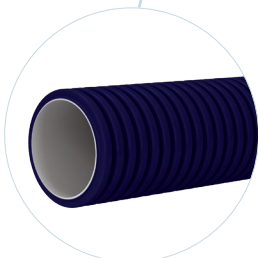
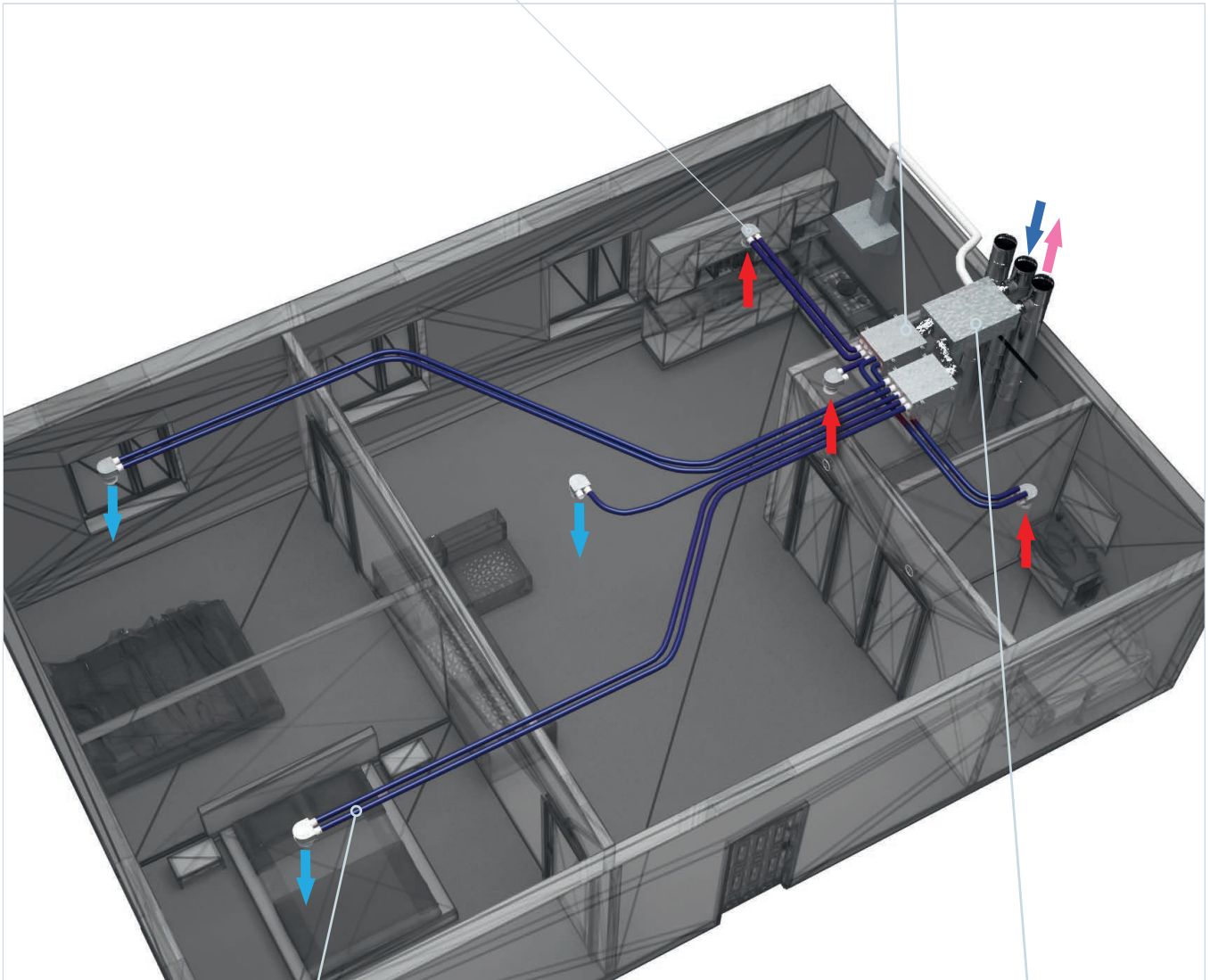
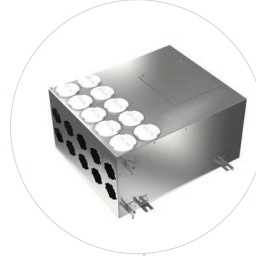

FlexiVent air duct

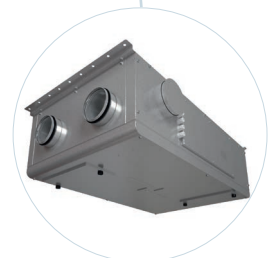

Air handling unit